

# Ammeraal Beltech Modular

Innovative belt and chain solutions  
for every industry & application



## Local Contacts

Authorised distributor Ammeral Beltech:

**TYMA CZ, s.r.o.**

Na Pískách 731

400 04 Trmce

Tel: +420 475 655 010

E-mail: [info@tyma.cz](mailto:info@tyma.cz), <http://www.tyma.cz>

# Content

uni ACB Closed	page 7 - 10
uni ACB Rough (POX-FR)	page 11 - 14
uni ACB Rough (POM NL)	page 15 - 18
uni ACB 2% Rough (POX -FR)	page 19 - 22
uni ACB 2% Rough (POM NL)	page 23 - 26
uni BLB 18%	page 27 - 30
uni BLB 22%	page 31 - 34
uni BLB 38%	page 35 - 38
uni CNB C	page 39 - 42
uni CNB 18%	page 43 - 46
uni CNB 22%	page 47 - 50
uni CPB C	page 51 - 54
uni CPB Rough Embedded	page 55 - 56
uni CPB Rough 20%	page 57 - 60
uni CPB Rough	page 61 - 64
uni CPB M2 C	page 65 - 68
uni CPB M2 Rough	page 69 - 72
uni CSB 8% Rough	page 73 - 76
uni CSB C	page 77 - 80
uni CSB Rough	page 81 - 84
uni ECB	page 85 - 86
uni JCB Y	page 87 - 88

# Content

uni L-SNB 36%	page 89 - 92
uni L-SNB 36% Rib	page 93 - 96
uni Light C	page 97 - 100
uni Light 10%	page 101 - 104
uni Light 22%	page 105 - 108
uni Light Rough	page 109 - 112
uni Light 10% SR	page 113 - 116
uni Light 18%	page 117 - 120
uni Light Rib	page 121 - 124
uni Light Vacuum	page 125 - 126
uni Light EP C	page 127 - 130
uni Light EP 22% Fine-meshed	page 131 - 134
uni Light EP Rib	page 135 - 138
uni Light EP 8.5%	page 139 - 142
uni Light EP 18%	page 143 - 146
uni Light EP 22%	page 147 - 150
uni Light EP 28%	page 151 - 154
uni Light EP 33%	page 155 - 158
uni Light EP 33% Rib	page 159 - 162
uni Light EP 46%	page 163 - 166
uni Light EP Vacuum	page 167 - 170
uni LPB Rough	page 171 - 172
uni M-OWL	page 173 - 174
uni M-SNB M2 14%	page 175 - 178

# Content

uni M-SNB M3 14%	page 179 - 182
uni M-TTB 37%	page 183 - 186
uni M-TTB CS 37%	page 187 - 190
uni M-QNB NS	page 191 - 192
uni M-QNB Vacuum	page 193 - 194
uni M-QNB C	page 195 - 198
uni MPB C - Core Range	page 199 - 200
uni MPB 22% - Core Range	page 201 - 202
uni MPB C	page 203 - 206
uni MPB 16%	page 207 - 210
uni MPB 18%	page 211 - 214
uni MPB 20%	page 215 - 218
uni MPB 22%	page 219 - 222
uni Pop-up flight	page 223 - 226
uni MPB Flights	page 227 - 230
uni MPB G	page 231 - 234
uni MPB N	page 235 - 238
uni MPB RO	page 239 - 240
uni NTB C	page 241 - 242
uni OPB 4 C	page 243 - 246
uni OPB 4 Vacuum	page 247 - 250
uni OPB 4V 23% Fine-meshed	page 251 - 254
uni OPB 4V 23% Rib	page 255 - 258
uni OPB 4V 23%	page 259 - 262

# Content

uni OPB 4V 36%	page 263 - 266
uni OPB 4V C	page 267 - 270
uni OPB 4V Rough	page 271 - 274
uni OPB 4V Vacuum	page 275 - 278
uni OPB 8 20%	page 279 - 282
uni OPB 8 25%	page 283 - 286
uni OPB 8 C	page 287 - 290
uni OPB 8M C	page 291 - 294
uni OPB 8P C	page 295 - 298
uni OPB 8 Rough	page 299 - 302
uni OWL 66%	page 303 - 304
uni QNB C	page 305 - 308
uni QNB Rough	page 309 - 312
uni QNB Ball	page 313 - 314
uni RTB M1	page 315 - 316
uni RTB M2 Rubber Top	page 317 - 318
uni RTB M2	page 319 - 320
uni RTB M1 8% Open	page 321 - 322
uni S-MPB C	page 323 - 326
uni S-MPB CS 22%	page 327 - 330
uni S-MPB N	page 331 - 334
uni SNB M2 20%	page 335 - 338
uni SNB M2 34%	page 339 - 342
uni SNB M2 Rib 34%	page 343 - 346

# Content

uni SNB M2 50%	page 347 - 350
uni SSB C	page 351 - 354
uni SSB 22%	page 355 - 358
uni SSB 29%	page 359 - 362
uni SSB 32%	page 363 - 366
uni X-MPB C	page 367 - 368
uni XLB M2 C	page 369 - 372
uni XLB M2 Rough	page 373 - 376
uni XLB M2 15% Rough	page 377 - 380
uni XLB M2 V8	page 381 - 382



# Plastic Modular Belt

Series **uni ACB** Type **Closed**

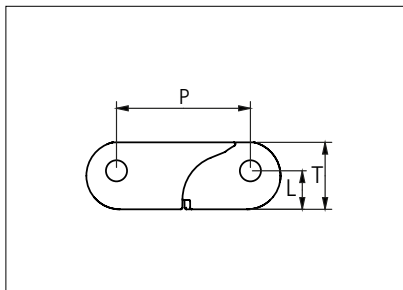

Straight running belt  
 Nominal pitch: 40.0 mm (1.57 in)  
 Surface type: Flat  
 Surface opening: Closed  
 Backflex radius: 60.0 mm (2.36 in)  
 Pin diameter: 6.0 mm (0.24 in)

<b>Belt material &amp; color</b>	POM NL <b>K</b>		<b>mm</b>	<b>in</b>		<b>mm</b>	<b>in</b>
<b>Pin and lock material &amp; color</b>	PA6.6 <b>B</b> PP <b>O</b>	<b>P (Nominal)</b>	40.0	1.57	<b>S</b>	0.8	0.03
		<b>L</b>	11.5	0.45	<b>T</b>	20.0	0.79

Non standard material and color: See uni Material and Color Overview.  
 Safety edges with orange or yellow edge links mounted on alternating pitches along both belt edges are optional.  
 Alternative pin and lock systems and materials: Contact Customer Service.

Belt width		Permissible tensile force (Belt/pin material)				Belt weight (Belt/pin material)				*Min No drive sprocket per shaft	Number of wear strips (min no)	
		POM-NL/PA6.6		POM-NL/SS		POM-NL/PA6.6		POM-NL/SS			Carry (pcs)	Return (pcs)
mm	in	N	lbf	N	lbf	Kg/m	lb/ft	Kg/m	lb/ft			
203	8.0	14210	3194	16240	3651	3.1	2.07	4.0	2.71	2	2	2
305	12.0	21350	4799	24400	5485	4.6	3.12	6.1	4.08	3	3	2
406	16.0	28420	6389	32480	7302	6.2	4.15	8.1	5.43	3	3	2
507	20.0	35490	7978	40560	9118	7.7	5.18	10.1	6.78	4	4	2
609	24.0	42630	9583	48720	10952	9.3	6.22	12.1	8.14	5	5	3
710	28.0	49700	11173	56800	12769	10.8	7.25	14.1	9.50	5	5	3
811	31.9	56770	12762	64880	14585	12.3	8.28	16.1	10.85	6	6	3
913	35.9	63910	14367	73040	16419	13.9	9.33	18.2	12.21	7	7	4
1014	39.9	70980	15956	81120	18236	15.4	10.36	20.2	13.56	7	7	4
1116	43.9	78120	17561	89280	20070	17.0	11.40	22.2	14.93	8	8	4

Additional standard belt widths are available in steps of 50.7 mm (2.00 in). Additional non-standard belt widths are available in steps of 16.9 mm (0.67 in).

1977	77.8	138390	31110	158160	35554	30.1	20.20	39.3	26.44	14	14	7
------	------	--------	-------	--------	-------	------	-------	------	-------	----	----	---

Additional standard belt widths are available in steps of 50.7 mm (2.00 in). Additional non-standard belt widths are available in steps of 16.9 mm (0.67 in).

2991	117.8	209370	47066	239280	53790	45.5	30.55	59.5	40.00	20	20	10
------	-------	--------	-------	--------	-------	------	-------	------	-------	----	----	----

Additional standard belt widths are available in steps of 50.7 mm (2.00 in). Additional non-standard belt widths are available in steps of 16.9 mm (0.67 in).

4005	157.7	280350	63023	320400	72026	60.9	40.91	79.7	53.56	27	27	14
------	-------	--------	-------	--------	-------	------	-------	------	-------	----	----	----

General belt tolerance is +/-0.4% at 23°C/73°F and 50% RH. For exact belt width contact Customer Service. Non standard belt width on request.

\*Max. Load per Drive Sprocket. Belt material: POM-NL 8000 N (1799 lbf).

= Single Link



STANDARD

STRAIGHT RUNNING

PITCH 40.0 MM/1.57 IN

## Accessories

### Top/Bottom Insert

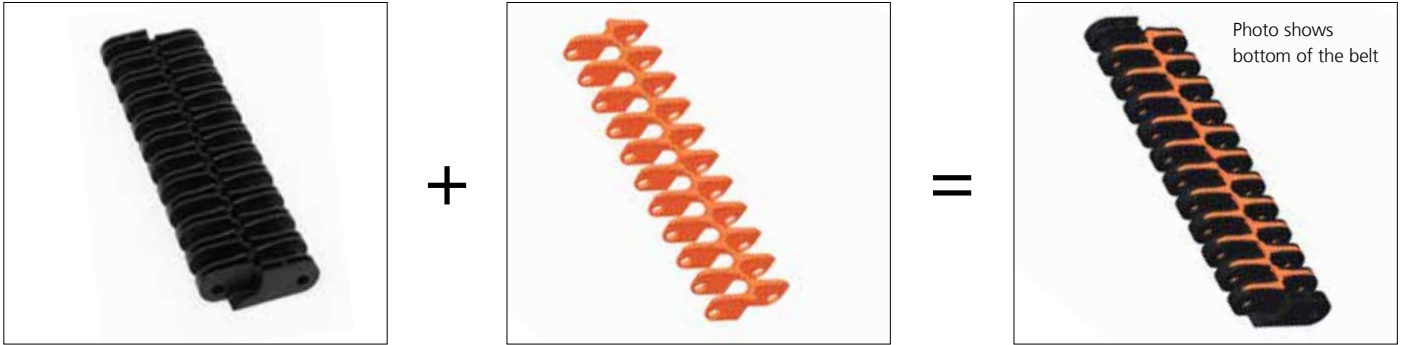

Type	Insert material & color	Weight	
		kg/m <sup>2</sup>	lb/ft <sup>2</sup>
Wheel Plate	POM DK <span style="color: orange;">○</span>	3.81	0.79

Contact area/wear surface of belt will increase from 25% to 49% by the use of inserts.

## Accessories

### Top/Bottom Insert

EC insert in uni ACB 2% Rough type can be build in to uni ACB Closed to create an electrical conductive belt.



Type	Insert material & color	Weight	
		kg/m <sup>2</sup>	lb/ft <sup>2</sup>
Electrical Conductive	POM-EC <span style="background-color: black; color: white;">K</span>	2.29	0.47

Contact area/wear surface of belt will increase from 25% to 38% by the use of inserts.

POM-EC and POX-FREC holds a surface resistivity of 1x10<sup>6</sup> Ohm according to IEC 60093/ASTM D257.

## Accessories

### Flight

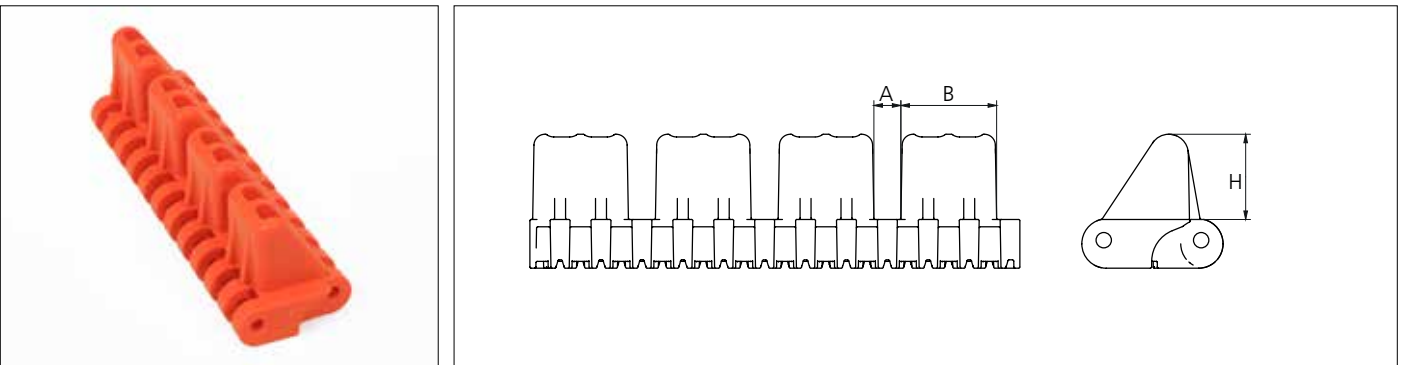

Type	Flight material & color	A		B		H		Link size	Width	
		mm	in	mm	in	mm	in		mm	in
Car pusher	POM-NL <span style="color: orange;">○</span>	11.0	0.43	39.0	1.54	35.0	1.38	K800	203.0	8.00

Backflex radius when flights are used: 120.0 mm (4.72 in).



## Sprocket

No of teeth	Bore size					Overall diameter		Pitch-diameter		Hub-diameter		Dimension A		Dimension B		Double row/One way	 MACHINED PAG
	Pilot bore	in	2.36	3.54	3.54												
		mm	60.0	90.0	120.0	mm	in	mm	in	mm	in	mm	in	mm	in		
Z16	✓		■	■		213.0	8.4	205.4	8.1	175.8	6.9	89.1	3.5	110.9	4.4	✓	✓
Z20	✓			■	■	264.2	10.4	256.0	10.1	227.9	9.0	114.8	4.5	136.3	5.4	✓	✓

### ■ Machined sprocket

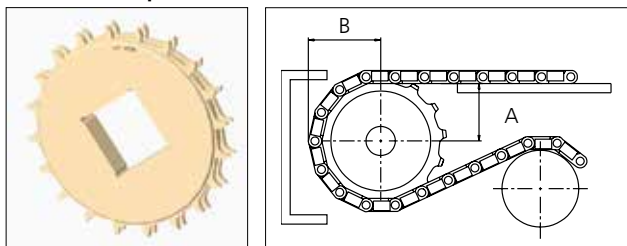

Non standard material and color:  
See uni Material and Color Overview.

Other sprocket sizes are available upon request.

Two-part sprockets are available upon request.

Other bore sizes are available upon request.

uni Retainer Rings: See uni Retainer Ring data sheet

Width of single tooth = 6.5 mm (0.25 in)

Width of sprocket = 33.2 mm (1.31 in)

Max load per sprocket shown does not take bore size into account.

Please also ensure that sufficient size shaft is chosen for corresponding load.

For correct sprocket position: See uni Assembly Instructions for uni ACB.

For more detailed sprocket information, contact Customer Service.



Conveyor Belts



Seamless Belts

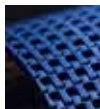

Modular Belts



Timing Belts



Transmission Belts



Fabrication & service

Expert advice, quality solutions and local service for all your belting needs [www.ammeraalbeltech.com](http://www.ammeraalbeltech.com)

**Ammeraal Beltech Modular A/S**  
Hjulmagervej 21  
DK-7100 Vejle

T +45 7572 3100  
F +45 7572 3348  
admin@unichains.com  
www.unichains.com

This information is subject to alteration due to continuous development. Ammeraal Beltech will not be held liable for the incorrect use of the above stated information. This information replaces previous information. All activities performed and services rendered by Ammeraal Beltech are subject to general terms and conditions of sale and delivery, as applied by its operating companies.



# Plastic Modular Belt

Series **uni ACB** Type **Rough**

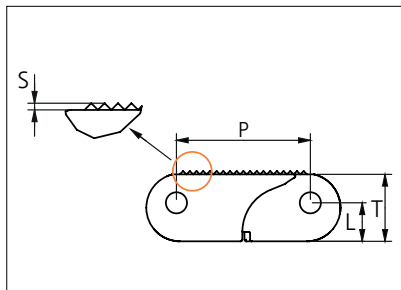

Straight running belt  
 Nominal pitch: 40.0 mm (1.57 in)  
 Surface type: Rough  
 Surface opening: Closed  
 Backflex radius: 60.0 mm (2.36 in)  
 Pin diameter: 6.0 mm (0.24 in)

<b>Belt material &amp; color</b>	POX FR <b>EG</b>		<b>mm</b>	<b>in</b>		<b>mm</b>	<b>in</b>
<b>Pin and lock material &amp; color</b>	PBT <b>LG</b> PP <b>O</b>	<b>P (Nominal)</b>	40.0	1.57	<b>S</b>	0.8	0.03
		<b>L</b>	11.5	0.45	<b>T</b>	20.0	0.79

Non standard material and color: See uni Material and Color Overview.  
 Safety edges with orange or yellow edge links mounted on alternating pitches along both belt edges are optional.  
 Alternative pin and lock systems and materials: Contact Customer Service.

Belt width		Permissible tensile force (Belt/pin material)				Belt weight (Belt/pin material)				*Min No drive sprocket per shaft	Number of wear strips (min no)	
		POX-FR/PBT		POX-FR/SS		POX-FR/PBT		POX-FR/SS			Carry (pcs)	Return (pcs)
mm	in	N	lbf	N	lbf	Kg/m	lb/ft	Kg/m	lb/ft			
204	8.0	14280	3210	16320	3669	2.5	1.69	3.4	2.32	2	2	2
306	12.0	21420	4815	24480	5503	3.8	2.53	5.2	3.48	3	3	2
407	16.0	28490	6405	32560	7319	5.0	3.36	6.9	4.62	3	3	2
509	20.0	35630	8010	40720	9154	6.3	4.21	8.6	5.78	4	4	2
611	24.1	42770	9615	48880	10988	7.5	5.05	10.3	6.94	5	5	3
713	28.1	49910	11220	57040	12823	8.8	5.89	12.0	8.10	5	5	3
814	32.0	56980	12809	65120	14639	10.0	6.73	13.8	9.25	6	6	3
916	36.1	64120	14414	73280	16473	11.3	7.57	15.5	10.40	7	7	4
1018	40.1	71260	16019	81440	18308	12.5	8.42	17.2	11.56	7	7	4
1120	44.1	78400	17624	89600	20142	13.8	9.26	18.9	12.72	8	8	4
1984	78.1	138880	31220	158720	35680	24.4	16.40	33.5	22.53	14	14	7
3002	118.2	210140	47239	240160	53988	36.9	24.82	50.7	34.10	21	21	11
4019	158.2	281330	63243	321520	72278	49.4	33.22	67.9	45.65	27	27	14

Additional standard belt widths are available in steps of 50.7 mm (2.00 in). Additional non-standard belt widths are available in steps of 16.9 mm (0.67 in).

Additional standard belt widths are available in steps of 50.7 mm (2.00 in). Additional non-standard belt widths are available in steps of 16.9 mm (0.67 in).

Additional standard belt widths are available in steps of 50.7 mm (2.00 in). Additional non-standard belt widths are available in steps of 16.9 mm (0.67 in).

General belt tolerance is +0/-0.4% at 23°C/73°F and 50% RH. For exact belt width contact Customer Service. Non standard belt width on request.

\*Max. Load per Drive Sprocket. Belt material: POX-FR 8000 N (1799 lbf).

= Single Link



STANDARD

STRAIGHT RUNNING

PITCH 40.0 MM/1.57 IN

## Accessories

### Top/Bottom Insert



Type	Insert material & color	Weight	
		kg/m <sup>2</sup>	lb/ft <sup>2</sup>
Wheel Plate	POM DK <span style="color: orange;">○</span>	3.81	0.79

Contact area/wear surface of belt will increase from 25% to 49% by the use of inserts.

## Accessories

### Top/Bottom Insert

EC insert in uni ACB 2% Rough type can be build in to uni ACB Closed to create an electrical conductive belt.



Type	Insert material & color	Weight	
		kg/m <sup>2</sup>	lb/ft <sup>2</sup>
Electrical Conductive	POX-FREC <span style="background-color: black; color: white;">K</span>	2.29	0.47

Contact area/wear surface of belt will increase from 25% to 38% by the use of inserts.

POM-EC and POX-FREC holds a surface resistivity of 1x10<sup>6</sup> Ohm according to IEC 60093/ASTM D257.

## Accessories

### Flight

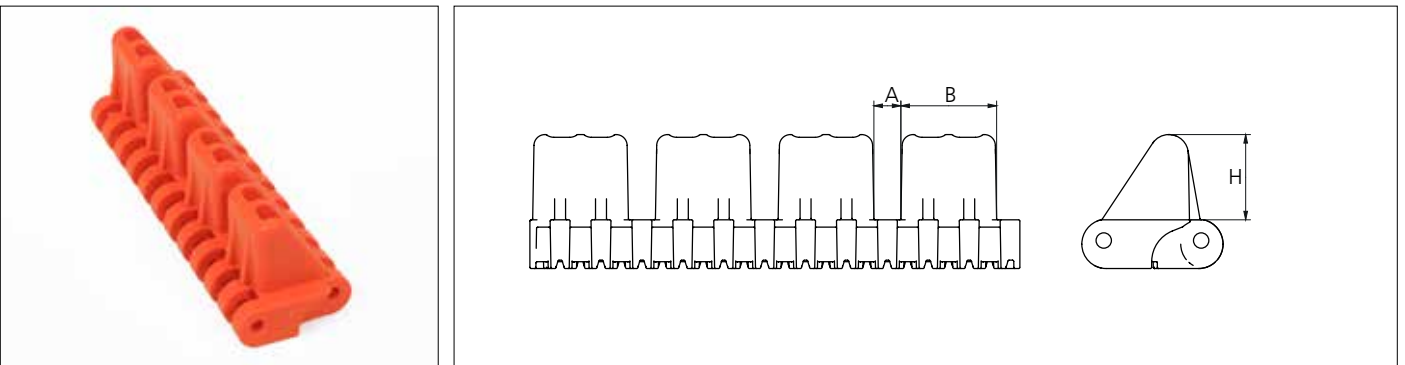

Type	Flight material & color	A		B		H		Link size	Width	
		mm	in	mm	in	mm	in		mm	in
Car pusher	POX FR <span style="color: orange;">○</span>	11.0	0.43	39.0	1.54	35.0	1.38	K800	203.0	8.00

Backflex radius when flights are used: 120.0 mm (4.72 in).

## Sprocket

No of teeth	Bore size					Overall diameter		Pitch-diameter		Hub-diameter		Dimension A		Dimension B		Double row/One way	 MACHINED PAG
	Pilot bore	in	2.36	3.54	3.54												
		mm	60.0	90.0	120.0	mm	in	mm	in	mm	in	mm	in	mm	in		
Z16	✓		■	■		213.0	8.4	205.4	8.1	175.8	6.9	89.1	3.5	110.9	4.4	✓	✓
Z20	✓			■	■	264.2	10.4	256.0	10.1	227.9	9.0	114.8	4.5	136.3	5.4	✓	✓

### ■ Machined sprocket

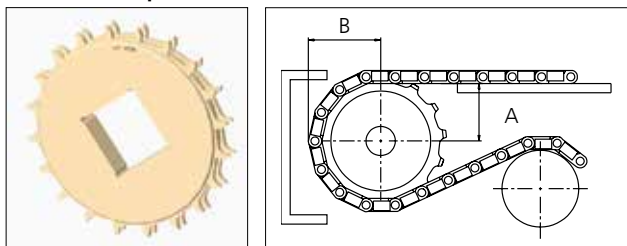

Non standard material and color:  
See uni Material and Color Overview.

Other sprocket sizes are available upon request.

Two-part sprockets are available upon request.

Round bores are always delivered with keyway.

Other bore sizes are available upon request.

uni Retainer Rings: See uni Retainer Ring data sheet

Width of single tooth = 6.5 mm (0.25 in)

Width of sprocket = 33.2 mm (1.31 in)

Max load per sprocket shown does not take bore size into account.

Please also ensure that sufficient size shaft is chosen for corresponding load.

For correct sprocket position: See uni Assembly Instructions for uni ACB.

For more detailed sprocket information, contact Customer Service.



Conveyor Belts



Seamless Belts



Modular Belts



Timing Belts



Transmission Belts



Fabrication & service

Expert advice, quality solutions and local service for all your belting needs [www.ammeraalbeltech.com](http://www.ammeraalbeltech.com)

**Ammeraal Beltech Modular A/S**  
Hjulmagervej 21  
DK-7100 Vejle

T +45 7572 3100  
F +45 7572 3348  
admin@unichains.com  
www.unichains.com

This information is subject to alteration due to continuous development. Ammeraal Beltech will not be held liable for the incorrect use of the above stated information. This information replaces previous information. All activities performed and services rendered by Ammeraal Beltech are subject to general terms and conditions of sale and delivery, as applied by its operating companies.



# Plastic Modular Belt

Series **uni ACB** Type **Rough**

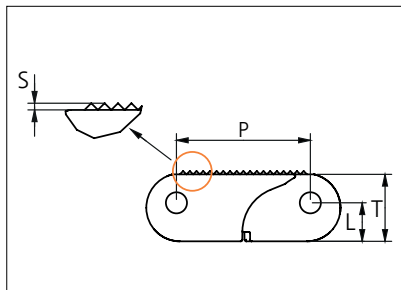

Straight running belt  
 Nominal pitch: 40.0 mm (1.57 in)  
 Surface type: Rough  
 Surface opening: Closed  
 Backflex radius: 60.0 mm (2.36 in)  
 Pin diameter: 6.0 mm (0.24 in)

<b>Belt material &amp; color</b>	POM NL <b>K</b>		<b>mm</b>	<b>in</b>		<b>mm</b>	<b>in</b>
<b>Pin and lock material &amp; color</b>	PA6.6 <b>B</b> PP <b>O</b>	<b>P (Nominal)</b>	40.0	1.57	<b>S</b>	0.8	0.03
		<b>L</b>	11.5	0.45	<b>T</b>	20.0	0.79

Non standard material and color: See uni Material and Color Overview.  
 Safety edges with orange or yellow edge links mounted on alternating pitches along both belt edges are optional.  
 Alternative pin and lock systems and materials: Contact Customer Service.

Belt width		Permissible tensile force (Belt/pin material)				Belt weight (Belt/pin material)				*Min No drive sprocket per shaft	Number of wear strips (min no)	
		POM-NL/PA6.6		POM-NL/SS		POM-NL/PA6.6		POM-NL/SS			Carry (pcs)	Return (pcs)
mm	in	N	lbf	N	lbf	Kg/m	lb/ft	Kg/m	lb/ft			
203	8.0	14210	3194	16240	3651	3.1	2.07	4.0	2.71	2	2	2
305	12.0	21350	4799	24400	5485	4.6	3.12	6.1	4.08	3	3	2
406	16.0	28420	6389	32480	7302	6.2	4.15	8.1	5.43	3	3	2
507	20.0	35490	7978	40560	9118	7.7	5.18	10.1	6.78	4	4	2
609	24.0	42630	9583	48720	10952	9.3	6.22	12.1	8.14	5	5	3
710	28.0	49700	11173	56800	12769	10.8	7.25	14.1	9.50	5	5	3
811	31.9	56770	12762	64880	14585	12.3	8.28	16.1	10.85	6	6	3
913	35.9	63910	14367	73040	16419	13.9	9.33	18.2	12.21	7	7	4
1014	39.9	70980	15956	81120	18236	15.4	10.36	20.2	13.56	7	7	4
1116	43.9	78120	17561	89280	20070	17.0	11.40	22.2	14.93	8	8	4

Additional standard belt widths are available in steps of 50.7 mm (2.00 in). Additional non-standard belt widths are available in steps of 16.9 mm (0.67 in).

1977	77.8	138390	31110	158160	35554	30.1	20.20	39.3	26.44	14	14	7
------	------	--------	-------	--------	-------	------	-------	------	-------	----	----	---

Additional standard belt widths are available in steps of 50.7 mm (2.00 in). Additional non-standard belt widths are available in steps of 16.9 mm (0.67 in).

2991	117.8	209370	47066	239280	53790	45.5	30.55	59.5	40.00	20	20	10
------	-------	--------	-------	--------	-------	------	-------	------	-------	----	----	----

Additional standard belt widths are available in steps of 50.7 mm (2.00 in). Additional non-standard belt widths are available in steps of 16.9 mm (0.67 in).

4005	157.7	280350	63023	320400	72026	60.9	40.91	79.7	53.56	27	27	14
------	-------	--------	-------	--------	-------	------	-------	------	-------	----	----	----

General belt tolerance is +/-0.4% at 23°C/73°F and 50% RH. For exact belt width contact Customer Service. Non standard belt width on request.

\*Max. Load per Drive Sprocket. Belt material: POM-NL 8000 N (1799 lbf).

= Single Link



STANDARD

STRAIGHT RUNNING

PITCH 40.0 MM/1.57 IN

## Accessories

### Top/Bottom Insert

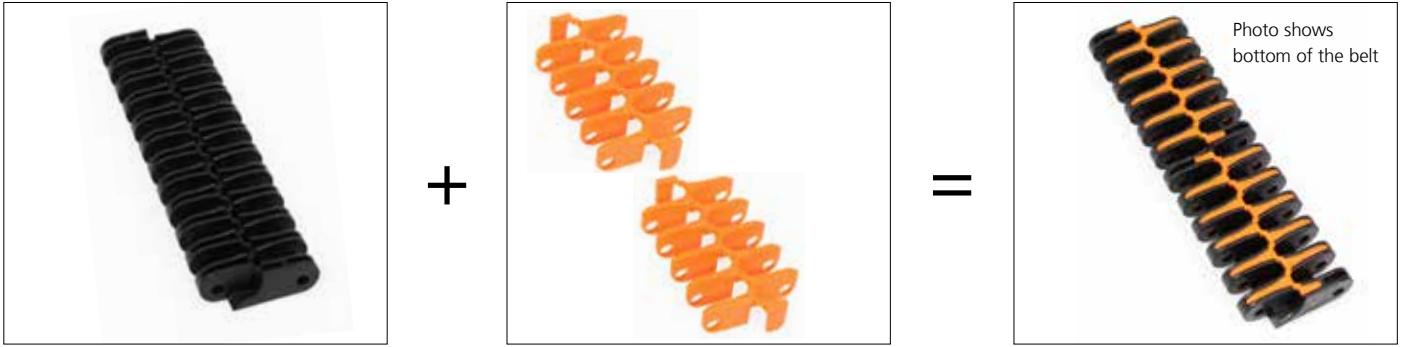

Type	Insert material & color	Weight	
		kg/m <sup>2</sup>	lb/ft <sup>2</sup>
Wheel Plate	POM DK <span style="color: orange;">○</span>	3.81	0.79

Contact area/wear surface of belt will increase from 25% to 49% by the use of inserts.

## Accessories

### Top/Bottom Insert

EC insert in uni ACB 2% Rough type can be build in to uni ACB Closed to create an electrical conductive belt.



Type	Insert material & color	Weight	
		kg/m <sup>2</sup>	lb/ft <sup>2</sup>
Electrical Conductive	POM-EC <span style="background-color: black; color: white;">K</span>	2.29	0.47

Contact area/wear surface of belt will increase from 25% to 38% by the use of inserts.

POM-EC and POX-FREC holds a surface resistivity of 1x10<sup>6</sup> Ohm according to IEC 60093/ASTM D257.

## Accessories

### Flight

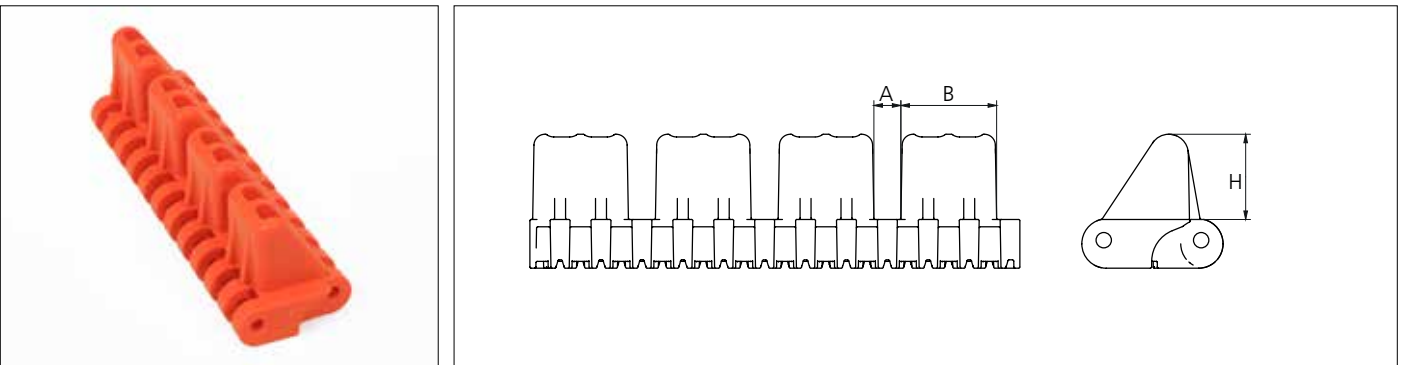

Type	Flight material & color	A		B		H		Link size	Width	
		mm	in	mm	in	mm	in		mm	in
Car pusher	POM-NL <span style="color: orange;">○</span>	11.0	0.43	39.0	1.54	35.0	1.38	K800	203.0	8.00

Backflex radius when flights are used: 120.0 mm (4.72 in).



### Sprocket

No of teeth	Bore size					Overall diameter		Pitch-diameter		Hub-diameter		Dimension A		Dimension B		Double row/One way	 MACHINED PAG
	Pilot bore	in	2.36	3.54	3.54												
		mm	60.0	90.0	120.0	mm	in	mm	in	mm	in	mm	in	mm	in		
Z16	✓		■	■		213.0	8.4	205.4	8.1	175.8	6.9	89.1	3.5	110.9	4.4	✓	✓
Z20	✓			■	■	264.2	10.4	256.0	10.1	227.9	9.0	114.8	4.5	136.3	5.4	✓	✓

■ Machined sprocket

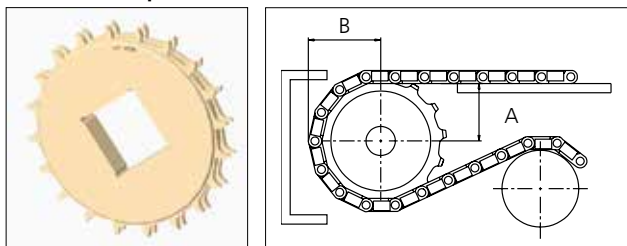

Non standard material and color:  
See uni Material and Color Overview.

Other sprocket sizes are available upon request.

Two-part sprockets are available upon request.

Round bores are always delivered with keyway.

Other bore sizes are available upon request.

uni Retainer Rings: See uni Retainer Ring data sheet

Width of single tooth = 6.5 mm (0.25 in)

Width of sprocket = 33.2 mm (1.31 in)

Max load per sprocket shown does not take bore size into account.  
Please also ensure that sufficient size shaft is chosen for corresponding load.

For correct sprocket position: See uni Assembly Instructions for uni ACB.  
For more detailed sprocket information, contact Customer Service.



Conveyor Belts



Seamless Belts

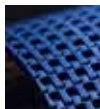

Modular Belts



Timing Belts



Transmission Belts



Fabrication & service

Expert advice, quality solutions and local service for all your belting needs [www.ammeraalbeltech.com](http://www.ammeraalbeltech.com)

**Ammeraal Beltech Modular A/S**  
Hjulmagervej 21  
DK-7100 Vejle

T +45 7572 3100  
F +45 7572 3348  
admin@unichains.com  
www.unichains.com

This information is subject to alteration due to continuous development. Ammeraal Beltech will not be held liable for the incorrect use of the above stated information. This information replaces previous information. All activities performed and services rendered by Ammeraal Beltech are subject to general terms and conditions of sale and delivery, as applied by its operating companies.



# Plastic Modular Belt

Series **uni ACB** Type **2% Rough**

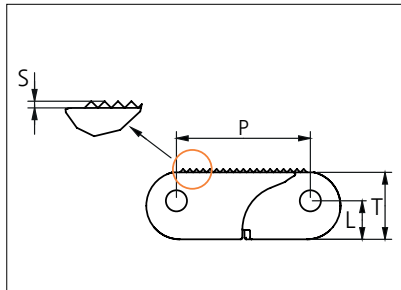

Straight running belt  
 Nominal pitch: 40.0 mm (1.57 in)  
 Surface type: Rough  
 Surface opening: 2% Open  
 Backflex radius: 60.0 mm (2.36 in)  
 Pin diameter: 6.0 mm (0.24 in)

<b>Belt material &amp; color</b>	POX FR <span style="border: 1px solid black; padding: 0 2px;">EG</span>		<b>mm</b>	<b>in</b>		<b>mm</b>	<b>in</b>
<b>Pin and lock material &amp; color</b>	<span style="border: 1px solid black; padding: 0 2px;">PBT</span> <span style="border: 1px solid black; padding: 0 2px;">LG</span> <span style="border: 1px solid black; padding: 0 2px;">PP</span> <span style="border: 1px solid black; padding: 0 2px;">O</span>	<b>P (Nominal)</b>	40.0	1.57	<b>S</b>	0.8	0.03
		<b>L</b>	11.5	0.45	<b>T</b>	20.0	0.79

Non standard material and color: See uni Material and Color Overview.  
 Safety edges with orange or yellow edge links mounted on alternating pitches along both belt edges are optional.  
 Alternative pin and lock systems and materials: Contact Customer Service.

Belt width		Permissible tensile force (Belt/pin material)				Belt weight (Belt/pin material)				*Min No drive sprocket per shaft	Number of wear strips (min no)	
		POX-FR/PBT		POX-FR/SS		POX-FR/PBT		POX-FR/SS			Carry (pcs)	Return (pcs)
mm	in	N	lbf	N	lbf	Kg/m	lb/ft	Kg/m	lb/ft			
204	8.0	14280	3210	16320	3669	2.5	1.69	3.5	2.33	2	2	2
306	12.0	21420	4815	24480	5503	3.8	2.53	5.2	3.50	3	3	2
408	16.1	28560	6420	32640	7337	5.0	3.37	6.9	4.66	3	3	2
509	20.0	35630	8010	40720	9154	6.3	4.21	8.7	5.82	4	4	2
611	24.1	42770	9615	48880	10988	7.5	5.05	10.4	6.98	5	5	3
713	28.1	49910	11220	57040	12823	8.8	5.89	12.1	8.15	5	5	3
815	32.1	57050	12825	65200	14657	10.0	6.74	13.9	9.31	6	6	3
916	36.1	64120	14414	73280	16473	11.3	7.57	15.6	10.47	7	7	4
1018	40.1	71260	16019	81440	18308	12.5	8.42	17.3	11.63	7	7	4
1120	44.1	78400	17624	89600	20142	13.8	9.26	19.0	12.80	8	8	4
1985	78.1	138950	31236	158800	35698	24.4	16.41	33.7	22.68	14	14	7
3003	118.2	210210	47255	240240	54006	36.9	24.82	51.1	34.31	21	21	11
4021	158.3	281470	63274	321680	72314	49.5	33.24	68.4	45.94	27	27	14

Additional standard belt widths are available in steps of 50.7 mm (2.00 in). Additional non-standard belt widths are available in steps of 16.9 mm (0.67 in).

Additional standard belt widths are available in steps of 50.7 mm (2.00 in). Additional non-standard belt widths are available in steps of 16.9 mm (0.67 in).

Additional standard belt widths are available in steps of 50.7 mm (2.00 in). Additional non-standard belt widths are available in steps of 16.9 mm (0.67 in).

General belt tolerance is +0/-0.4% at 23°C/73°F and 50% RH. For exact belt width contact Customer Service. Non standard belt width on request.

\*Max. Load per Drive Sprocket. Belt material: POX-FR 8000 N (1799 lbf).

= Single Link



STANDARD

STRAIGHT RUNNING

PITCH 40.0 MM/1.57 IN

## Accessories

### Top/Bottom Insert



Type	Insert material & color	Weight	
		kg/m <sup>2</sup>	lb/ft <sup>2</sup>
Wheel Plate	POM DK <span style="color: orange;">○</span>	3.81	0.79

Contact area/wear surface of belt will increase from 25% to 49% by the use of inserts.

## Accessories

### Top/Bottom Insert

EC insert in uni ACB 2% Rough type can be build in to uni ACB Closed to create an electrical conductive belt.



Type	Insert material & color	Weight	
		kg/m <sup>2</sup>	lb/ft <sup>2</sup>
Electrical Conductive	POM-EC <span style="background-color: black; color: white;">K</span>	2.29	0.46

Contact area/wear surface of belt will increase from 25% to 38% by the use of inserts.

POM-EC and POX-FREC holds a surface resistivity of 1x10<sup>6</sup> Ohm according to IEC 60093/ASTM D257.

## Accessories

### Flight

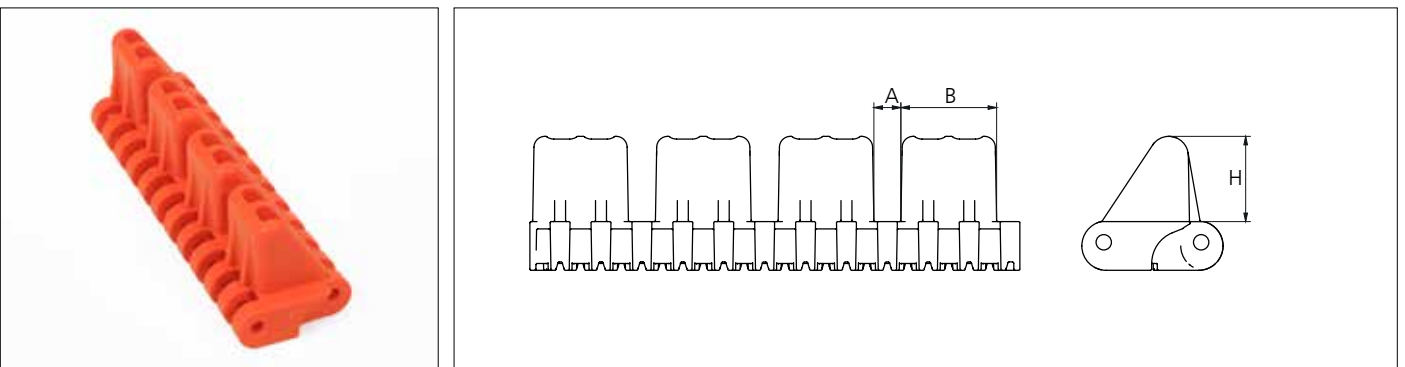

Type	Flight material & color	A		B		H		Link size	Width	
		mm	in	mm	in	mm	in		mm	in
Car pusher	POX FR <span style="color: orange;">○</span>	11.0	0.43	39.0	1.54	35.0	1.38	K800	203.0	8.00

Backflex radius when flights are used: 120.0 mm (4.72 in).

### Sprocket

No of teeth	Bore size					Overall diameter		Pitch-diameter		Hub-diameter		Dimension A		Dimension B		Double row/One way	 MACHINED PAG
	Pilot bore	in	2.36	3.54	3.54												
		mm	60.0	90.0	120.0	mm	in	mm	in	mm	in	mm	in				
Z16	✓		■	■		213.0	8.4	205.4	8.1	175.8	6.9	89.1	3.5	110.9	4.4	✓	✓
Z20	✓			■	■	264.2	10.4	256.0	10.1	227.9	9.0	114.8	4.5	136.3	5.4	✓	✓

■ Machined sprocket

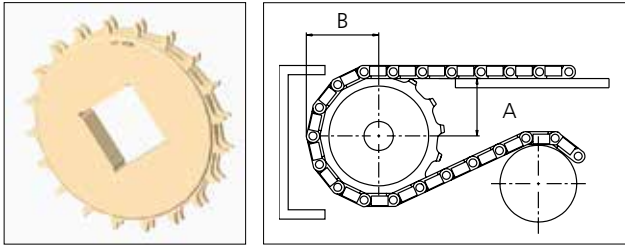

Non standard material and color:  
See uni Material and Color Overview.

Other sprocket sizes are available upon request.

Two-part sprockets are available upon request.

Round bores are always delivered with keyway.

Other bore sizes are available upon request.

uni Retainer Rings: See uni Retainer Ring data sheet

Width of single tooth = 6.5 mm (0.25 in)

Width of sprocket = 33.2 mm (1.31 in)

Max load per sprocket shown does not take bore size into account.

Please also ensure that sufficient size shaft is chosen for corresponding load.

For correct sprocket position: See uni Assembly Instructions for uni ACB.

For more detailed sprocket information, contact Customer Service.



Conveyor Belts



Seamless Belts



Modular Belts



Timing Belts



Transmission Belts



Fabrication & service

Expert advice, quality solutions and local service for all your belting needs [www.ammeraalbeltech.com](http://www.ammeraalbeltech.com)

**Ammeraal Beltech Modular A/S**  
Hjulmagervej 21  
DK-7100 Vejle

T +45 7572 3100  
F +45 7572 3348  
admin@unichains.com  
www.unichains.com

This information is subject to alteration due to continuous development. Ammeraal Beltech will not be held liable for the incorrect use of the above stated information. This information replaces previous information. All activities performed and services rendered by Ammeraal Beltech are subject to general terms and conditions of sale and delivery, as applied by its operating companies.



# Plastic Modular Belt

Series **uni ACB** Type **2% Rough**

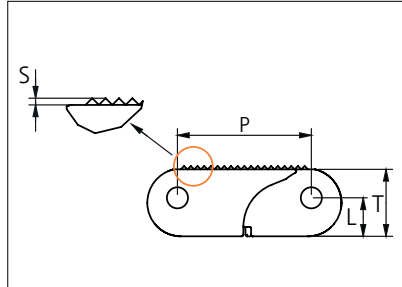

Straight running belt  
 Nominal pitch: 40.0 mm (1.57 in)  
 Surface type: Rough  
 Surface opening: 2% Open  
 Backflex radius: 60.0 mm (2.36 in)  
 Pin diameter: 6.0 mm (0.24 in)

STANDARD

<b>Belt material &amp; color</b>	POM NL <b>K</b>		<b>mm</b>	<b>in</b>		<b>mm</b>	<b>in</b>
<b>Pin and lock material &amp; color</b>	PA6.6 <b>B</b> PP <b>O</b>	<b>P (Nominal)</b>	40.0	1.57	<b>S</b>	0.8	0.03
		<b>L</b>	11.5	0.45	<b>T</b>	20.0	0.79

Non standard material and color: See uni Material and Color Overview.  
 Safety edges with orange or yellow edge links mounted on alternating pitches along both belt edges are optional.  
 Alternative pin and lock systems and materials: Contact Customer Service.

STRAIGHT RUNNING

Belt width		Permissible tensile force (Belt/pin material)				Belt weight (Belt/pin material)				*Min No drive sprocket per shaft	Number of wear strips (min no)	
		POM-NL/PA6.6		POM-NL/SS		POM-NL/PA6.6		POM-NL/SS			Carry (pcs)	Return (pcs)
mm	in	N	lbf	N	lbf	Kg/m	lb/ft	Kg/m	lb/ft			
203	8.0	14210	3194	16240	3651	3.0	2.03	4.0	2.67	2	2	2
304	12.0	21280	4784	24320	5467	4.5	3.04	6.0	4.00	3	3	2
406	16.0	28420	6389	32480	7302	6.0	4.07	8.0	5.35	3	3	2
507	20.0	35490	7978	40560	9118	7.6	5.08	9.9	6.68	4	4	2
608	23.9	42560	9567	48640	10934	9.1	6.09	11.9	8.01	5	5	3
710	28.0	49700	11173	56800	12769	10.6	7.11	13.9	9.35	5	5	3
811	31.9	56770	12762	64880	14585	12.1	8.12	15.9	10.68	6	6	3
912	35.9	63840	14351	72960	16401	13.6	9.13	17.9	12.01	7	7	4
1014	39.9	70980	15956	81120	18236	15.1	10.15	19.9	13.36	7	7	4
1115	43.9	78050	17546	89200	20052	16.6	11.17	21.9	14.69	8	8	4

Additional standard belt widths are available in steps of 50.7 mm (2.00 in.) Additional non-standard belt widths are available in steps of 16.9 mm (0.67 in.)

1976	77.8	138320	31094	158080	35536	29.4	19.79	38.7	26.03	14	14	7
------	------	--------	-------	--------	-------	------	-------	------	-------	----	----	---

Additional standard belt widths are available in steps of 50.7 mm (2.00 in.) Additional non-standard belt widths are available in steps of 16.9 mm (0.67 in.)

2989	117.7	209230	47035	239120	53754	44.5	29.93	58.6	39.37	20	20	10
------	-------	--------	-------	--------	-------	------	-------	------	-------	----	----	----

Additional standard belt widths are available in steps of 50.7 mm (2.00 in.) Additional non-standard belt widths are available in steps of 16.9 mm (0.67 in.)

4002	157.6	280140	62975	320160	71972	59.6	40.07	78.4	52.72	27	27	14
------	-------	--------	-------	--------	-------	------	-------	------	-------	----	----	----

General belt tolerance is +0/-0.4% at 23°C/73°F and 50% RH. For exact belt width contact Customer Service. Non standard belt width on request.

\*Max. Load per Drive Sprocket. Belt material: POM-NL 8000 N (1799 lbf).

= Single Link

PITCH 40.0 MM/1.57 IN



## Accessories

### Top/Bottom Insert

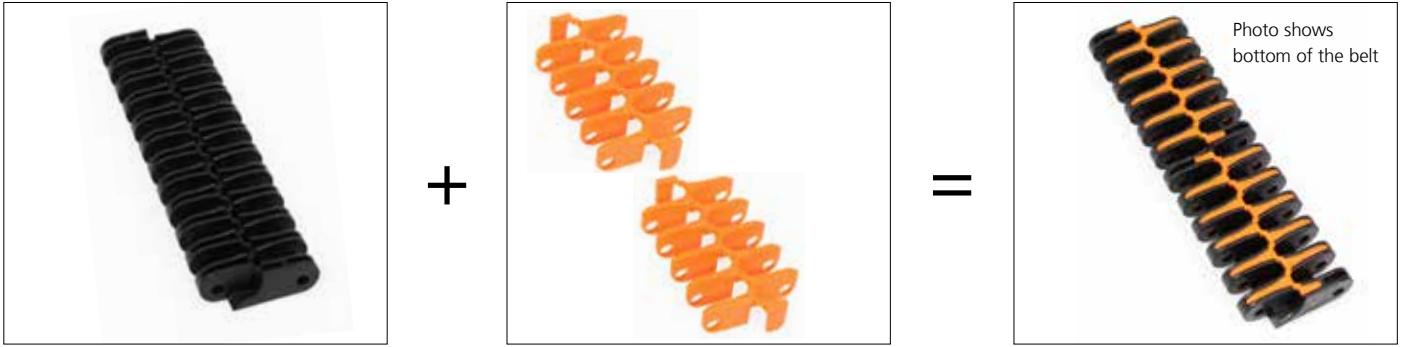

Type	Insert material & color	Weight	
		kg/m <sup>2</sup>	lb/ft <sup>2</sup>
Wheel Plate	POM DK <span style="color: orange;">○</span>	3.81	0.79

Contact area/wear surface of belt will increase from 25% to 49% by the use of inserts.

## Accessories

### Top/Bottom Insert

EC insert in uni ACB 2% Rough type can be build in to uni ACB Closed to create an electrical conductive belt.



Type	Insert material & color	Weight	
		kg/m <sup>2</sup>	lb/ft <sup>2</sup>
Electrical Conductive	POM-EC <span style="background-color: black; color: white;">K</span>	2.29	0.47

Contact area/wear surface of belt will increase from 25% to 38% by the use of inserts.

POM-EC and POX-FREC holds a surface resistivity of 1x10<sup>6</sup> Ohm according to IEC 60093/ASTM D257.

## Accessories

### Flight

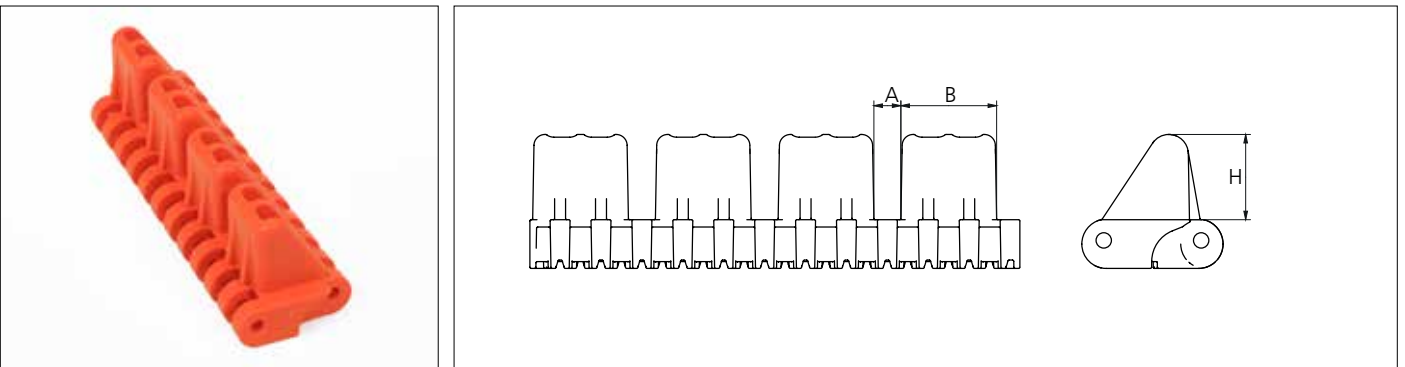

Type	Flight material & color	A		B		H		Link size	Width	
		mm	in	mm	in	mm	in		mm	in
Car pusher	POM-NL <span style="color: orange;">○</span>	11.0	0.43	39.0	1.54	35.0	1.38	K800	203.0	8.00

Backflex radius when flights are used: 120.0 mm (4.72 in).



## Sprocket

No of teeth	Bore size					Overall diameter		Pitch-diameter		Hub-diameter		Dimension A		Dimension B		Double row/One way	 MACHINED PAG
	Pilot bore	in	2.36	3.54	3.54												
		mm	60.0	90.0	120.0	mm	in	mm	in	mm	in	mm	in				
Z16	✓		■	■		213.0	8.4	205.4	8.1	175.8	6.9	89.1	3.5	110.9	4.4	✓	✓
Z20	✓			■	■	264.2	10.4	256.0	10.1	227.9	9.0	114.8	4.5	136.3	5.4	✓	✓

### ■ Machined sprocket

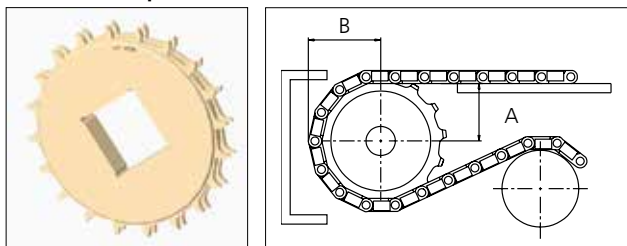

Non standard material and color:  
See uni Material and Color Overview.

Other sprocket sizes are available upon request.

Two-part sprockets are available upon request.

Round bores are always delivered with keyway.

Other bore sizes are available upon request.

uni Retainer Rings: See uni Retainer Ring data sheet

Width of single tooth = 6.5 mm (0.25 in)

Width of sprocket = 33.2 mm (1.31 in)

Max load per sprocket shown does not take bore size into account.

Please also ensure that sufficient size shaft is chosen for corresponding load.

For correct sprocket position: See uni Assembly Instructions for uni ACB.

For more detailed sprocket information, contact Customer Service.



Conveyor Belts



Seamless Belts

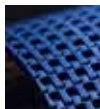

Modular Belts



Timing Belts



Transmission Belts



Fabrication & service

Expert advice, quality solutions and local service for all your belting needs [www.ammeraalbeltech.com](http://www.ammeraalbeltech.com)

**Ammeraal Beltech Modular A/S**  
Hjulmagervej 21  
DK-7100 Vejle

T +45 7572 3100  
F +45 7572 3348  
admin@unichains.com  
www.unichains.com

This information is subject to alteration due to continuous development. Ammeraal Beltech will not be held liable for the incorrect use of the above stated information. This information replaces previous information. All activities performed and services rendered by Ammeraal Beltech are subject to general terms and conditions of sale and delivery, as applied by its operating companies.



# Plastic Modular Belt

Series **uni BLB** Type **18%**

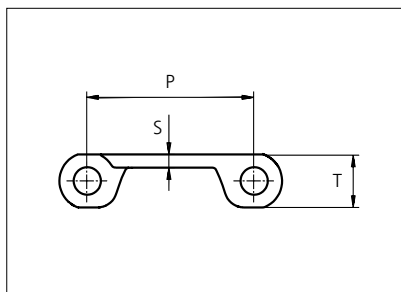
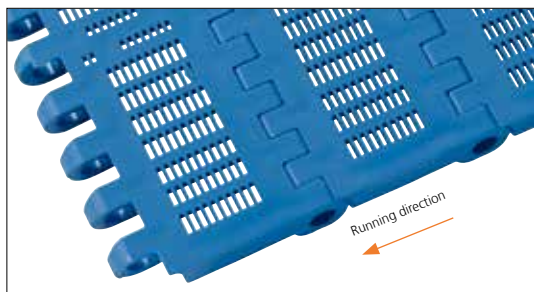

Straight running belt  
 Nominal pitch: 50.8 mm (2.00 in)  
 Surface type: Flat  
 Surface opening: 18%  
 Backflex radius: 65.0 mm (2.60 in)  
 Pin diameter: 8.0 mm (0.31 in)

<b>Belt material &amp; color</b>	PP-HW <b>LB</b>	<b>mm</b>	<b>in</b>		<b>mm</b>	<b>in</b>
<b>Pin and lock material &amp; color</b>	<b>SS304</b> <b>PP-HW LB</b>	<b>P (Nominal)</b>	50.8	2.00	<b>T</b>	16.0 0.63
		<b>S</b>	4.0	0.16	-	-

Non standard material and color: See uni Material and Color Overview.

Alternative pin and lock materials: Lockpin: PP-HW **LB**

Belt width		***Permissible tensile force (Belt/pin material)				Belt weight (Belt/pin material)				*Min. No. drive sprocket per shaft	Number of wear strips (Min. No.)	
		PP-HW/SS		PP-HW/ PP-HW		PP-HW/SS		PP-HW/PP-HW			**Carry (pcs)	**Return (pcs)
mm	in	N	lbf	N	lbf	kg/m	lb/ft	kg/m	lb/ft			
153	6.0	1010	227	1010	227	1.8	1.20	0.7	0.49	2	2	2
306	12.0	2020	454	2020	454	3.6	2.41	1.5	0.99	3	3	2
357	14.0	2354	529	2354	529	4.2	2.80	1.7	1.15	3	3	2
408	16.1	2693	605	2693	605	4.8	3.21	2.0	1.32	3	3	2
459	18.1	3028	681	3028	681	5.4	3.61	2.2	1.48	4	4	2
509	20.1	3362	756	3362	756	6.0	4.01	2.4	1.64	4	4	2
560	22.1	3697	831	3697	831	6.6	4.40	2.7	1.81	4	4	2
611	24.1	4032	906	4032	906	7.1	4.80	2.9	1.97	5	5	3
662	26.0	4367	982	4367	982	7.7	5.20	3.2	2.13	5	5	3
713	28.1	4706	1058	4706	1058	8.3	5.61	3.4	2.30	5	5	3
764	30.1	5041	1133	5041	1133	8.9	6.01	3.7	2.46	6	6	3
815	32.1	5379	1209	5379	1209	9.5	6.41	3.9	2.63	6	6	3

Additional standard belt widths are available in steps of 50.7 mm (2.00 in).

1985	78.1	13101	2945	13101	2945	23.2	15.61	9.5	6.40	14	14	7
------	------	-------	------	-------	------	------	-------	-----	------	----	----	---

Additional standard belt widths are available in steps of 50.7 mm (2.00 in).

3003	118.2	19820	4455	19820	4455	35.1	23.61	14.4	9.69	21	21	11
------	-------	-------	------	-------	------	------	-------	------	------	----	----	----

General belt tolerance is +0/-0.4% at 23°C/73°F and 50% RH. For exact belt width contact Customer Service. Non standard belt width on request.

\*Max. Load per Drive Sprocket. Belt material: PP-HW with snub roller 2000 N (450 lbf), PP-HW without snub roller 1250 N (281 lbf).

\*\*Max. Spacing between wear strips, Carry: 152.0 mm (6.00 in); Return: 304.0 mm (12.00 in).

\*\*\*Load capacity per row of reinforcement links in the belt: 2500 N (562 lbf).

\*\*\*Example: Belt with 8 rows of reinforcement links, permissible load is 8 x 2500 N (562 lbf) = 20000 N (4496 lbf).

= Single Link



STANDARD

STRAIGHT RUNNING

PITCH 50.8 MM/2.00 IN

## Accessories

### Flight / Non Standard



uni MPB Flight

uni MPB Flights in PP-HW **LB** fits the BLB belt and are available on request. Please see the uni MPB Flight datasheet for more information.

## Accessories

### Side Guard

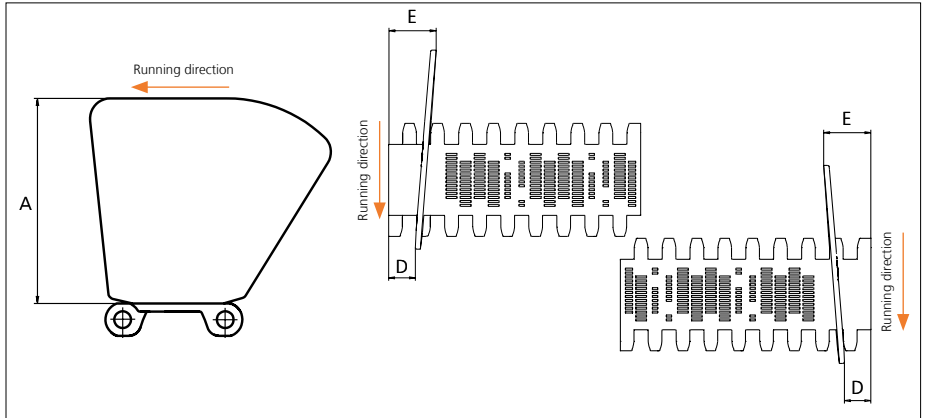

Type	Material & color	A		E		D	
		mm	in	mm	in	mm	in
Closed	PP-HW <b>LB</b>	101.6	4.00	28.5	1.12	16.0	0.63

Non Standard material and color: See uni Material and Color Overview.  
Backflex radius for Side Guard: 200.0 mm (7.90 in)

## Accessories

### Reinforcement Link

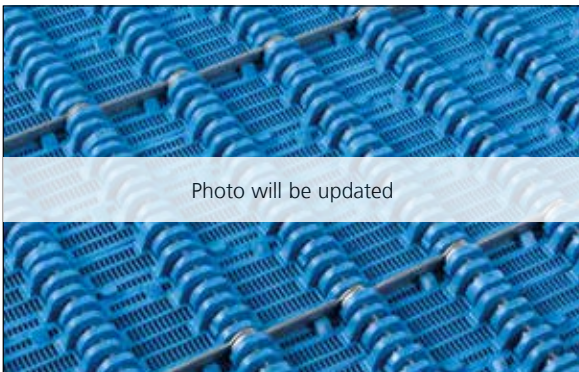

Load capacity per row of reinforcement links in the belt. Maximum 19 rows per metre belt width.  
Example: If seven rows are installed the max. permissible load of the belt is  $7 \times 2500 \text{ N (562 lbf)} = 17500 \text{ N (3934 lbf)}$ .

Type	Material & color	N/row	Lbf/row
Steel Link	<b>SS316</b>	2500	562

Non Standard material and color: See uni Material and Color Overview.

## Sprocket

No. of teeth	Bore size								Overall diameter		Pitch-diameter		Hub-diameter		Dimension A		Dimension B		Single row/One way	Molded PA6 LG	Machined PA6 N	
	Pilot bore		1.00	1.18	1.25	1.50	1.57	2.36														2.50
	mm	in	25.4	30.0	31.8	38.1	40.0	60.0	63.5	mm	in	mm	in	mm	in	mm	in					
Z08	✓	●	●	●	■	■				132.9	5.23	132.8	5.23	65.0	2.56	53.3	2.10	74.9	2.94	✓	✓	
Z10	✓		●	●	●	■	■			166.3	6.55	164.4	6.47	65.0	2.56	70.2	2.76	90.7	3.57	✓	✓	
Z10							■	■		166.3	6.55	164.4	6.47	120.0	4.72	70.2	2.76	90.7	3.57	✓	✓	
Z12	✓		●	●	●	■	■			198.6	7.82	196.3	7.73	65.0	2.56	86.8	3.42	106.6	4.19	✓	✓	
Z12							■	■		198.6	7.82	196.3	7.73	120.0	4.72	86.8	3.42	106.6	4.19	✓	✓	
Z16	✓		●	●	●	■	■	■	■	263.8	10.39	260.4	10.25	150.0	5.90	119.7	4.71	138.7	5.46	✓		✓

● Molded sprocket

■ Machined sprocket

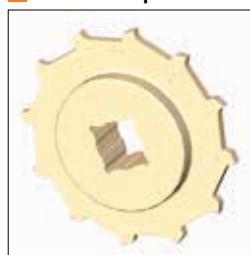

Other sprocket sizes are available upon request.

Other bore sizes on sprockets are available upon request.

Max. load per sprocket shown does not take bore size into account.

Please also ensure that sufficient size shaft is chosen for corresponding load.

Width of tooth = Single row 9.5 mm (0.37 in)

Width of One-part sprocket = Single row: 42.3 mm (1.67 in)

## uni UltraClean Two-Part Sprocket

No. of teeth	Bore size				Overall diameter		Pitch-diameter		Hub-diameter		Dimension A		Dimension B		Single row/One way	Moulded PA6 W
	in	1.50	1.57	2.36												
	mm	38.1	40.0	60.0	mm	in	mm	in	mm	in	mm	in	mm	in		
Z8		■	■		132.9	5.23	132.8	5.23	80.0	3.15	53.3	2.10	74.9	2.94	✓	✓
Z10		1 ■	1 ■	2 ■	166.3	6.55	164.4	6.47	<sup>1</sup> 126.0 <sup>2</sup> 118.0	<sup>1</sup> 4.96 <sup>2</sup> 4.65	70.2	2.76	90.7	3.57	✓	✓
Z12		1 ■	1 ■	2 ■	198.6	7.82	196.3	7.73	<sup>1</sup> 126.0 <sup>2</sup> 118.0	<sup>1</sup> 4.96 <sup>2</sup> 4.65	86.8	3.42	106.6	4.19	✓	✓

■ Moulded uni UltraClean TwoPart Sprocket

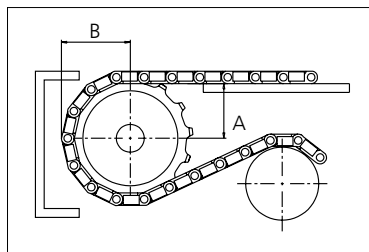

Width of UltraClean Two-part sprocket = Single row: 44.0 mm (1.73 in)

Width of UltraClean Two-part sprocket, tooth = Single row: 9.5 mm (0.37 in)

uni Retainer Rings: See uni Retainer Ring data sheet.

For correct sprocket position: See uni Assembly Instructions for uni BLB.

For more detailed sprocket information, contact Customer Service.



Conveyor Belts



Seamless Belts



Modular Belts



Timing Belts

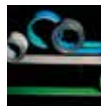

Transmission Belts



Fabrication & service

Expert advice, quality solutions and local service for all your belting needs [www.ammeraalbeltech.com](http://www.ammeraalbeltech.com)

**Ammeraal Beltech Modular A/S**  
Hjulmagervej 21  
DK-7100 Vejle

T +45 7572 3100  
F +45 7572 3348  
admin@unichains.com  
www.unichains.com

This information is subject to alteration due to continuous development. Ammeraal Beltech will not be held liable for the incorrect use of the above stated information. This information replaces previous information. All activities performed and services rendered by Ammeraal Beltech are subject to general terms and conditions of sale and delivery, as applied by its operating companies.



# Plastic Modular Belt

Series **uni BLB** Type **22%**

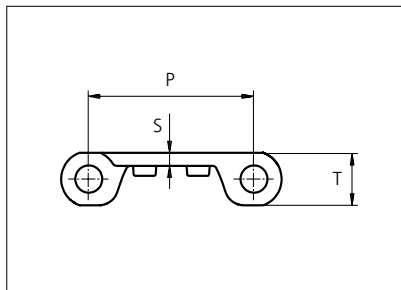

Straight running belt  
 Nominal pitch: 50.8 mm (2.00 in)  
 Surface type: Flat  
 Surface opening: 22%  
 Backflex radius: 65.0 mm (2.60 in)  
 Pin diameter: 8.0 mm (0.31 in)

Belt material & color	PP-HW <b>LB</b>		mm	in		mm	in
	Pin and lock material & color	SS304  PP-HW <b>LB</b>	P (Nominal)	50.8	2.00	T	16.0
S			4.0	0.16	-	-	-

Non standard material and color: See uni Material and Color Overview.

Alternative pin and lock materials: Lockpin: PP-HW **LB**

Belt width		***Permissible tensile force (Belt/pin material)				Belt weight (Belt/pin material)				*Min. No. drive sprocket per shaft	Number of wear strips (Min. No.)	
		PP-HW/SS		PP-HW/ PP-HW		PP-HW/SS		PP-HW/PP-HW			**Carry (pcs)	**Return (pcs)
mm	in	N	lbf	N	lbf	kg/m	lb/ft	kg/m	lb/ft			
152	6.0	1005	226	1005	226	1.8	1.20	0.7	0.49	2	2	2
305	12.0	2013	453	2013	453	3.6	2.40	1.5	0.98	3	3	2
356	14.0	2348	528	2348	528	4.2	2.80	1.7	1.15	3	3	2
406	16.0	2683	603	2683	603	4.8	3.20	2.0	1.31	3	3	2
457	18.0	3017	678	3017	678	5.3	3.59	2.2	1.47	4	4	2
508	20.0	3352	754	3352	754	5.9	3.99	2.4	1.64	4	4	2
559	22.0	3687	829	3687	829	6.5	4.39	2.7	1.80	4	4	2
609	24.0	4022	904	4022	904	7.1	4.79	2.9	1.97	5	5	3
660	26.0	4356	979	4356	979	7.7	5.19	3.2	2.13	5	5	3
711	28.0	4691	1055	4691	1055	8.3	5.59	3.4	2.29	5	5	3
762	30.0	5026	1130	5026	1130	8.9	5.99	3.7	2.46	6	6	3
812	32.0	5361	1205	5361	1205	9.5	6.39	3.9	2.62	6	6	3

Additional standard belt widths are available in steps of 50.7 mm (2.00 in).

1979	77.9	13061	2936	13061	2936	23.2	15.56	9.5	6.38	14	14	7
------	------	-------	------	-------	------	------	-------	-----	------	----	----	---

Additional standard belt widths are available in steps of 50.7 mm (2.00 in).

2994	117.9	19760	4442	19760	4442	35.0	23.54	14.4	9.66	20	20	10
------	-------	-------	------	-------	------	------	-------	------	------	----	----	----

General belt tolerance is +0/-0.4% at 23°C/73°F and 50% RH . For exact belt width contact Customer Service. Non standard belt width on request.

\*Max. Load per Drive Sprocket. Belt material: PP-HW with snub roller 2000 N (450 lbf), PP-HW without snub roller 1250 N (281 lbf)

\*\*Max. Spacing between wear strips, Carry: 152.0 mm (6.00 in); Return: 304.0 mm (12.00 in).

\*\*\*Load capacity per row of reinforcement links in the belt: 2500 N (562 lbf)

\*\*\*Example: Belt with 8 rows of reinforcement links, permissible load is 8 x 2500 N (562 lbf) = 20000 N (4496 lbf)

= Single Link



STANDARD

STRAIGHT RUNNING

PITCH 50.8 MM/2.00 IN

## Accessories

### Flight / Non Standard

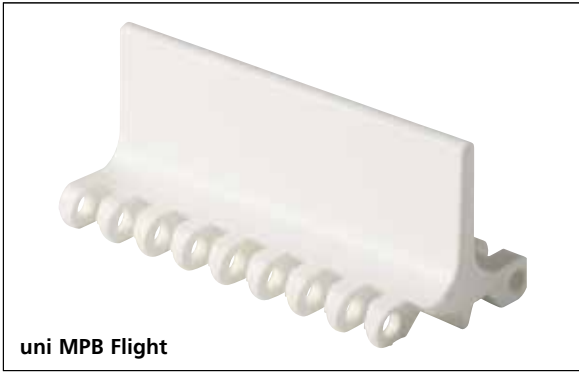

uni MPB Flight

uni MPB Flights in PP-HW **LB** fits the BLB belt and are available on request. Please see the uni MPB Flight datasheet for more information.

## Accessories

### Side Guard

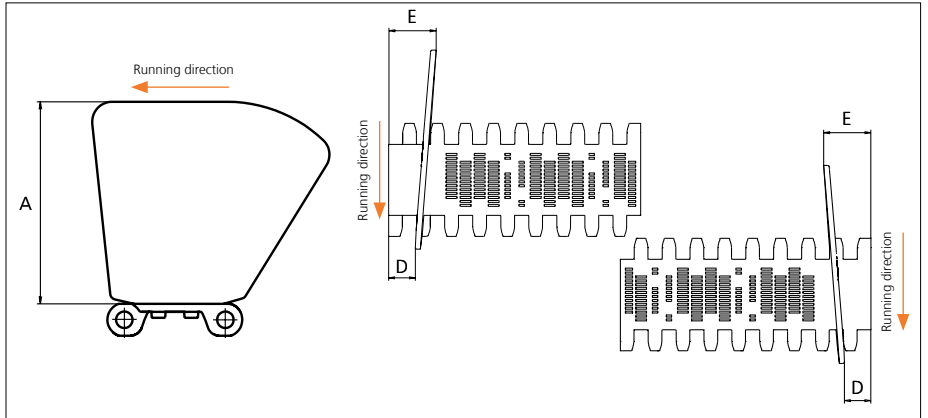

Type	Material & color	A		E		D	
		mm	in	mm	in	mm	in
Closed	PP-HW <b>LB</b>	101.6	4.00	28.5	1.12	16.0	0.63

Non Standard material and color: See uni Material and Color Overview.  
Backflex radius for Side Guard: 200.0 mm (7.90 in)

## Accessories

### Reinforcement Link



Load capacity per row of reinforcement links in the belt. Maximum 19 rows per metre belt width.  
Example: If seven rows are installed the max. permissible load of the belt is  $7 \times 2500 \text{ N (562 lbf)} = 17500 \text{ N (3934 lbf)}$ .

Type	Material & color	N/row	Lbf/row
Steel Link	<b>SS316</b>	2500	562

Non Standard material and color: See uni Material and Color Overview.



### Sprocket

No. of teeth	Bore size								Overall diameter		Pitch-diameter		Hub-diameter		Dimension A		Dimension B		Single row/One way	Molded PA6 LG	Machined PA6 N
	Pilot bore	in			mm																
		mm	25.4	30.0	31.8	38.1	40.0	60.0	63.5												
Z08	✓	●	●	●	■	■			132.9	5.23	132.8	5.23	65.0	2.56	53.3	2.10	74.9	2.94	✓	✓	
Z10	✓		●	●	■	■			166.3	6.55	164.4	6.47	65.0	2.56	70.2	2.76	90.7	3.57	✓	✓	
Z10							■	■	166.3	6.55	164.4	6.47	120.0	4.72	70.2	2.76	90.7	3.57	✓	✓	
Z12	✓		●	●	■	■			198.6	7.82	196.3	7.73	65.0	2.56	86.8	3.42	106.6	4.19	✓	✓	
Z12							■	■	198.6	7.82	196.3	7.73	120.0	4.72	86.8	3.42	106.6	4.19	✓	✓	
Z16	✓		●	●	■	■	■	■	263.8	10.39	260.4	10.25	150.0	5.90	119.7	4.71	138.7	5.46	✓		✓

● Molded sprocket

■ Machined sprocket

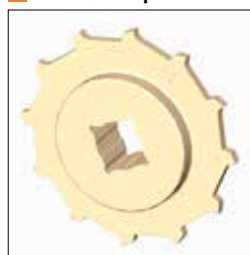

Other sprocket sizes are available upon request.

Other bore sizes on sprockets are available upon request.

Max. load per sprocket shown does not take bore size into account.

Please also ensure that sufficient size shaft is chosen for corresponding load.

Width of tooth = Single row 9.5 mm (0.37 in)

Width of One-part sprocket = Single row: 42.3 mm (1.67 in)

### uni UltraClean Two-Part Sprocket

No. of teeth	Bore size				Overall diameter		Pitch-diameter		Hub-diameter		Dimension A		Dimension B		Single row/One way	Moulded PA6 W
	in	1.50	1.57	2.36												
	mm	38.1	40.0	60.0	mm	in	mm	in	mm	in	mm	in				
Z8		■	■		132.9	5.23	132.8	5.23	80.0	3.15	53.3	2.10	74.9	2.94	✓	✓
Z10		1 ■	1 ■	2 ■	166.3	6.55	164.4	6.47	<sup>1</sup> 126.0 <sup>2</sup> 118.0	<sup>1</sup> 4.96 <sup>2</sup> 4.65	70.2	2.76	90.7	3.57	✓	✓
Z12		1 ■	1 ■	2 ■	198.6	7.82	196.3	7.73	<sup>1</sup> 126.0 <sup>2</sup> 118.0	<sup>1</sup> 4.96 <sup>2</sup> 4.65	86.8	3.42	106.6	4.19	✓	✓

■ Moulded uni UltraClean TwoPart Sprocket

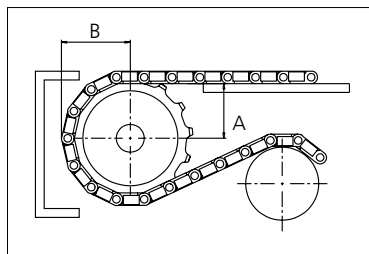

Width of UltraClean Two-part sprocket = Single row: 44.0 mm (1.73 in)

Width of UltraClean Two-part sprocket, tooth = Single row: 9.5 mm (0.37 in)

uni Retainer Rings: See uni Retainer Ring data sheet.

For correct sprocket position: See uni Assembly Instructions for uni BLB.

For more detailed sprocket information, contact Customer Service.



Conveyor Belts



Seamless Belts

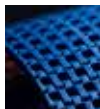

Modular Belts



Timing Belts

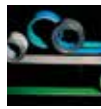

Transmission Belts



Fabrication & service

Expert advice, quality solutions and local service for all your belting needs [www.ammeraalbeltech.com](http://www.ammeraalbeltech.com)

**Ammeraal Beltech Modular A/S**  
Hjulmagervej 21  
DK-7100 Vejle

T +45 7572 3100  
F +45 7572 3348  
admin@unichains.com  
www.unichains.com

This information is subject to alteration due to continuous development. Ammeraal Beltech will not be held liable for the incorrect use of the above stated information. This information replaces previous information. All activities performed and services rendered by Ammeraal Beltech are subject to general terms and conditions of sale and delivery, as applied by its operating companies.



# Plastic Modular Belt

Series **uni BLB** Type **38%**

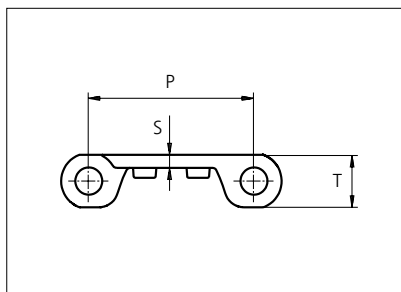
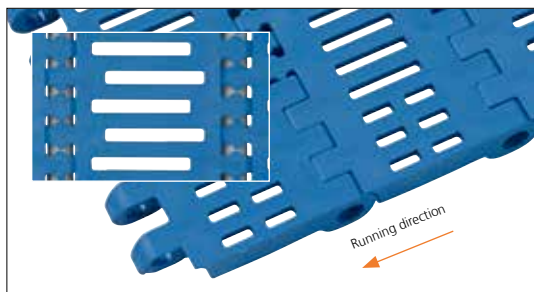

Straight running belt  
 Nominal pitch: 50.8 mm (2.00 in)  
 Surface type: Flat  
 Surface opening: 38%  
 Backflex radius: 65.0 mm (2.60 in)  
 Pin diameter: 8.0 mm (0.31 in)

Belt material & color	PP-HW <b>LB</b>		mm	in		mm	in
	Pin and lock material & color	<b>SS304</b> <b>PP-HW LB</b>	<b>P (Nominal)</b>	50.8	2.00	<b>T</b>	16.0
<b>S</b>			4.0	0.16	-	-	-

Non standard material and color: See uni Material and Color Overview.

Alternative pin and lock materials: Lockpin: PP-HW **LB**

Belt width		***Permissible tensile force (Belt/pin material)				Belt weight (Belt/pin material)				*Min. No. drive sprocket per shaft	Number of wear strips (Min. No.)	
		PP-HW/SS		PP-HW/ PP-HW		PP-HW/SS		PP-HW/PP-HW			**Carry (pcs)	**Return (pcs)
mm	in	N	lbf	N	lbf	kg/m	lb/ft	kg/m	lb/ft			
152	6.0	1005	226	1005	226	1.8	1.20	0.7	0.49	2	2	2
305	12.0	2013	453	2013	453	3.6	2.40	1.5	0.98	3	3	2
356	14.0	2348	528	2348	528	4.2	2.80	1.7	1.15	3	3	2
406	16.0	2683	603	2683	603	4.8	3.20	2.0	1.31	3	3	2
457	18.0	3017	678	3017	678	5.3	3.59	2.2	1.47	4	4	2
508	20.0	3352	754	3352	754	5.9	3.99	2.4	1.64	4	4	2
559	22.0	3687	829	3687	829	6.5	4.39	2.7	1.80	4	4	2
609	24.0	4022	904	4022	904	7.1	4.79	2.9	1.97	5	5	3
660	26.0	4356	979	4356	979	7.7	5.19	3.2	2.13	5	5	3
711	28.0	4691	1055	4691	1055	8.3	5.59	3.4	2.29	5	5	3
762	30.0	5026	1130	5026	1130	8.9	5.99	3.7	2.46	6	6	3
812	32.0	5361	1205	5361	1205	9.5	6.39	3.9	2.62	6	6	3

Additional standard belt widths are available in steps of 50.7 mm (2.00 in).

1979	77.9	13061	2936	13061	2936	23.2	15.56	9.5	6.38	14	14	7
------	------	-------	------	-------	------	------	-------	-----	------	----	----	---

Additional standard belt widths are available in steps of 50.7 mm (2.00 in).

2994	117.9	19760	4442	19760	4442	35.0	23.54	14.4	9.66	20	20	10
------	-------	-------	------	-------	------	------	-------	------	------	----	----	----

General belt tolerance is +0/-0.4% at 23°C/73°F and 50% RH. For exact belt width contact Customer Service. Non standard belt width on request.

\*Max. Load per Drive Sprocket. Belt material: PP-HW with snub roller 2000 N (450 lbf), PP-HW without snub roller 1250 N (281 lbf)

\*\*Max. Spacing between wear strips, Carry: 152.0 mm (6.00 in); Return: 304.0 mm (12.00 in).

\*\*\*Load capacity per row of reinforcement links in the belt: 2500 N (562 lbf) Example: Belt with 8 rows of reinforcement links,

\*\*\*Example: Belt with 8 rows of reinforcement links, permissible load is 8 x 2500 N (562 lbf) = 20000 N (4496 lbf)

= Single Link



STANDARD

STRAIGHT RUNNING

PITCH 50.8 MM/2.00 IN

## Accessories

### Flight / Non Standard



uni MPB Flight

uni MPB Flights in PP-HW **LB** fits the BLB belt and are available on request. Please see the uni MPB Flight datasheet for more information.

## Accessories

### Side Guard

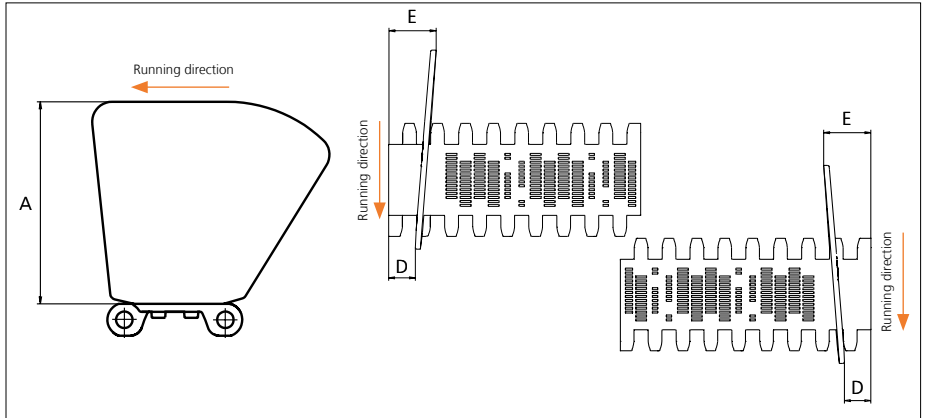

Type	Material & color	A		E		D	
		mm	in	mm	in	mm	in
Closed	PP-HW <b>LB</b>	101.6	4.00	28.5	1.12	16.0	0.63

Non Standard material and color: See uni Material and Color Overview.  
Backflex radius for Side Guard: 200.0 mm (7.90 in)

## Accessories

### Reinforcement Link



Load capacity per row of reinforcement links in the belt. Maximum 19 rows per metre belt width.  
Example: If seven rows are installed the max. permissible load of the belt is  $7 \times 2500 \text{ N (562 lbf)} = 17500 \text{ N (3934 lbf)}$ .

Type	Material & color	N/row	Lbf/row
Steel Link	<b>SS316</b>	2500	562

Non Standard material and color: See uni Material and Color Overview.

## Sprocket

No. of teeth	Bore size									Overall diameter		Pitch-diameter		Hub-diameter		Dimension A		Dimension B		Single row/One way	Molded PA6 LG	Machined PA6 N
	Pilot bore		1.00	1.18	1.25	1.50	1.57	2.36	2.50													
	mm	in	25.4	30.0	31.8	38.1	40.0	60.0	63.5	mm	in	mm	in	mm	in	mm	in					
Z08	✓	●	●	●	■	■				132.9	5.23	132.8	5.23	65.0	2.56	53.3	2.10	74.9	2.94	✓	✓	
Z10	✓		●	●	●	■	■			166.3	6.55	164.4	6.47	65.0	2.56	70.2	2.76	90.7	3.57	✓	✓	
Z10							■	■		166.3	6.55	164.4	6.47	120.0	4.72	70.2	2.76	90.7	3.57	✓	✓	
Z12	✓		●	●	●	■	■			198.6	7.82	196.3	7.73	65.0	2.56	86.8	3.42	106.6	4.19	✓	✓	
Z12							■	■		198.6	7.82	196.3	7.73	120.0	4.72	86.8	3.42	106.6	4.19	✓	✓	
Z16	✓		●	●	●	■	■	■	■	263.8	10.39	260.4	10.25	150.0	5.90	119.7	4.71	138.7	5.46	✓		✓

● Molded sprocket

■ Machined sprocket

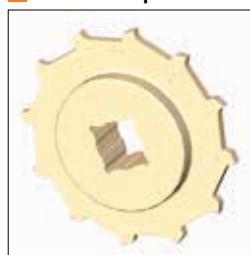

Other sprocket sizes are available upon request.

Other bore sizes on sprockets are available upon request.

Max. load per sprocket shown does not take bore size into account.

Please also ensure that sufficient size shaft is chosen for corresponding load.

Width of tooth = Single row: 9.5 mm (0.37 in)

Width of One-part sprocket = Single row: 42.3 mm (1.67 in)

## uni UltraClean Two-Part Sprocket

No. of teeth	Bore size				Overall diameter		Pitch-diameter		Hub-diameter		Dimension A		Dimension B		Single row/One way	Moulded PA6 W
	in	1.50	1.57	2.36												
	mm	38.1	40.0	60.0	mm	in	mm	in	mm	in	mm	in				
Z8		■	■		132.9	5.23	132.8	5.23	80.0	3.15	53.3	2.10	74.9	2.94	✓	✓
Z10		1 ■	1 ■	2 ■	166.3	6.55	164.4	6.47	<sup>1</sup> 126.0 <sup>2</sup> 118.0	<sup>1</sup> 4.96 <sup>2</sup> 4.65	70.2	2.76	90.7	3.57	✓	✓
Z12		1 ■	1 ■	2 ■	198.6	7.82	196.3	7.73	<sup>1</sup> 126.0 <sup>2</sup> 118.0	<sup>1</sup> 4.96 <sup>2</sup> 4.65	86.8	3.42	106.6	4.19	✓	✓

■ Moulded uni UltraClean TwoPart Sprocket

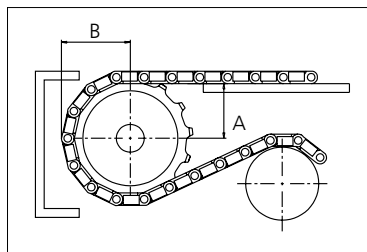

Width of UltraClean Two-part sprocket = Single row: 44.0 mm (1.73 in)

Width of UltraClean Two-part sprocket, tooth = Single row: 9.5 mm (0.37 in)

uni Retainer Rings: See uni Retainer Ring data sheet.

For correct sprocket position: See uni Assembly Instructions for uni BLB.

For more detailed sprocket information, contact Customer Service.



Conveyor Belts



Seamless Belts



Modular Belts



Timing Belts

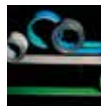

Transmission Belts



Fabrication & service

Expert advice, quality solutions and local service for all your belting needs [www.ammeraalbeltech.com](http://www.ammeraalbeltech.com)

**Ammeraal Beltech Modular A/S**  
Hjulmagervej 21  
DK-7100 Vejle

T +45 7572 3100  
F +45 7572 3348  
admin@unichains.com  
www.unichains.com

This information is subject to alteration due to continuous development. Ammeraal Beltech will not be held liable for the incorrect use of the above stated information. This information replaces previous information. All activities performed and services rendered by Ammeraal Beltech are subject to general terms and conditions of sale and delivery, as applied by its operating companies.



# Plastic Modular Belt

Series **uni CNB** Type **C**

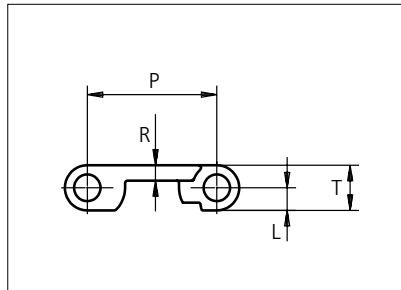

Straight running belt  
 Nominal pitch: 25.4 mm (1.00 in)  
 Surface type: Flat  
 Surface opening: Closed  
 Backflex radius: 40.0 mm (1.60 in)  
 Pin diameter: 5.0 mm (0.20 in)

Belt material & color	POM-D <b>W</b>	PP <b>W</b>	PP <b>B</b>	PE <b>N</b>	mm	in	T	mm	in
Pin material & color	PP <b>W</b>		PP <b>B</b>	PE <b>N</b>	mm	in	L	mm	in

Non standard material and color: See uni Material and Color Overview.

Alternative pin and lock materials: Pin: PE **W** PA6.6 **B** PBT **LG** SS304 Lockpin: PBT **LG** PA6.6 **N** PP **W** **B** PE **N**

Belt width		Permissible tensile force (Belt/pin material)						Belt weight (Belt/pin material)						*Min. No. drive sprocket per shaft	Number of wear strips (Min. No.)	
		POM-D/PP		PP/PP		PE/PE		POM-D/PP		PP/PP		PE/PE			**Carry (pcs)	**Return (pcs)
mm	in	N	lbf	N	lbf	N	lbf	kg/m	lb/ft	kg/m	lb/ft	kg/m	lb/ft			
77	3.0	1040	234	539	121	477	107	0.4	0.30	0.3	0.20	0.3	0.21	2	2	2
153	6.0	2065	464	1071	241	949	213	0.9	0.60	0.6	0.40	0.6	0.41	2	2	2
229	9.0	3091	695	1603	360	1420	319	1.3	0.89	0.9	0.60	0.9	0.62	2	2	2
305	12.0	4117	926	2135	480	1891	425	1.8	1.19	1.2	0.80	1.2	0.82	3	3	2
381	15.0	5143	1156	2667	600	2362	531	2.2	1.49	1.5	1.00	1.5	1.02	3	3	2
457	18.0	6169	1387	3199	719	2833	637	2.7	1.78	1.8	1.20	1.8	1.23	4	4	2
533	21.0	7195	1617	3731	839	3304	743	3.1	2.08	2.1	1.40	2.1	1.43	4	4	2
609	24.0	8221	1848	4263	958	3776	849	3.5	2.37	2.4	1.60	2.4	1.64	5	5	3
685	27.0	9247	2079	4795	1078	4247	955	4.0	2.67	2.7	1.80	2.7	1.84	5	5	3
761	30.0	10273	2309	5327	1197	4718	1061	4.4	2.97	3.0	1.99	3.0	2.05	6	6	3
837	33.0	11299	2540	5859	1317	5189	1167	4.9	3.26	3.3	2.19	3.3	2.25	6	6	3
913	35.9	12325	2771	6391	1437	5660	1272	5.3	3.56	3.6	2.39	3.7	2.45	7	7	4
989	38.9	13351	3001	6923	1556	6132	1378	5.7	3.85	3.9	2.59	4.0	2.66	7	7	4

Additional standard belt widths are available in steps of 76.0 mm (2.99 in). Additional non-standard belt widths are available in steps of 12.7 mm (0.50 in).

1977	77.8	26690	6000	13839	3111	12257	2755	11.5	7.71	7.7	5.18	7.9	5.31	14	14	7
------	------	-------	------	-------	------	-------	------	------	------	-----	------	-----	------	----	----	---

Additional standard belt widths are available in steps of 76.0 mm (2.99 in). Additional non-standard belt widths are available in steps of 12.7 mm (0.50 in).

2965	116.7	40028	8998	20755	4666	18383	4132	17.2	11.56	11.6	7.77	11.9	7.97	20	20	10
------	-------	-------	------	-------	------	-------	------	------	-------	------	------	------	------	----	----	----

General belt tolerance is +0/-0.4% at 23°C/73°F and 50% RH. For exact belt width contact Customer Service. Non standard belt width on request.

\*Max. Load per Drive Sprocket. Belt material: POM-D 600 N (135 lbf).PP 500 N (112 lbf)

\*\*Max. Spacing between wear strips. Carry: 152.0 mm (6.00 in); Return: 304.0 mm (12.00 in)

= Single Link



STANDARD

STRAIGHT RUNNING

PITCH 25.4 MM/1.00 IN

## Accessories

### Flight

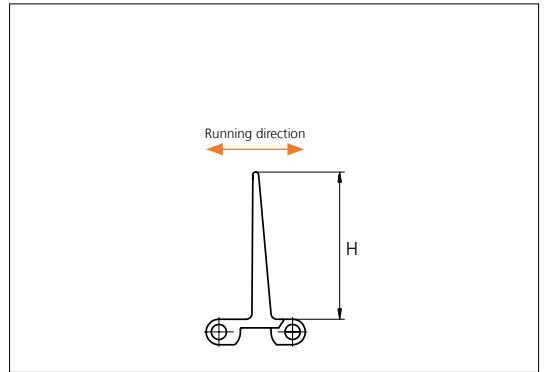
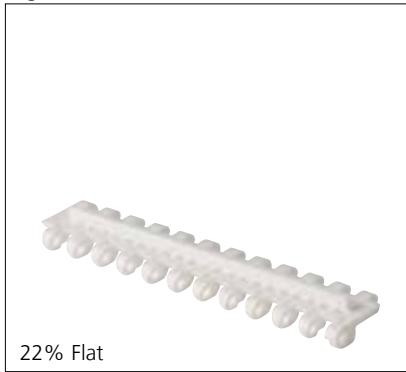

Type	Material & color	H		Link size	Width		Indent	
		mm	in		mm	in	mm	in
22% Flat	PE  PP-I	5.0	0.20	K300	75.9	2.99	6.4	0.25
					152.0	5.98		
Flat/waves	POM-D  PE PP-I  PP-I	25.4	1.00	K600	152.0	5.98	0.0	0.00
		50.8	2.00					
		76.2	3.00					

Minimum bricklaid indent is 38.1 mm (1.50 in). Increment: 12.7 mm (0.50 in).  
 Non Standard material and color: See uni Material and Color Overview.

## Accessories

### Side Guard

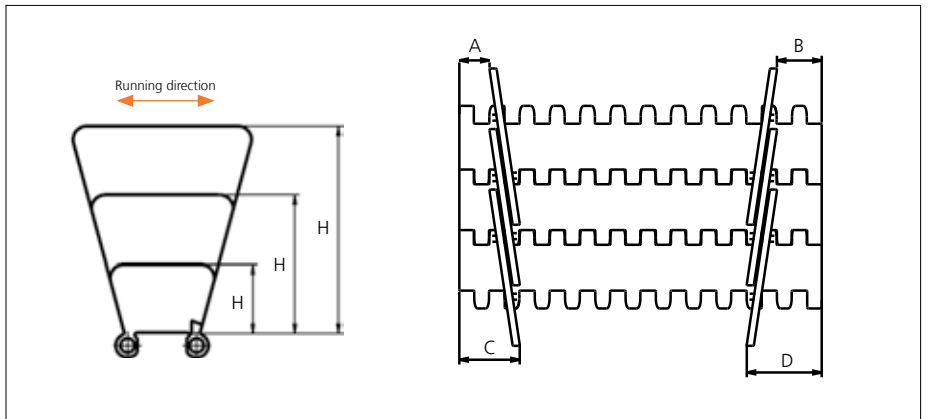

Type	Material & color	H		A (Min.)		B (Min.)		C (Min.)		D (Min.)	
		mm	in	mm	in	mm	in	mm	in	mm	in
Closed	PP-I	25.4	1.00	12.5	0.49	18.5	0.73	25.5	1.00	31.5	1.24
		50.8	2.00								
		76.2	3.00								

Minimum indent to outside of Side Guard: 14.0 mm (0.55 in). Increment 6.4 mm (0.25).  
 Non Standard material and color: See uni Material and Color Overview.  
 Backflex radius for Side Guard: 75.0 mm (2.95 in)



## Sprocket

No of teeth	Bore size								Overall diameter		Pitch diameter		Hub diameter		A-dimension		B-dimension		Double row/Two way	Molded	PA6 LG
	Pilot bore	in		1.00		1.18		1.25													
	mm	25.0	25.4	30.0	31.8	38.1	40.0	mm	in	mm	in	mm	in	mm	in	mm	in				
Z10	✓		●	●	●	●			80.0	3.15	82.2	3.24	70.0	2.76	34.7	1.37	45.5	1379	✓	✓	
Z12	✓			●	●	●			96.8	3.81	98.1	3.86	70.0	2.76	43.0	1.69	53.5	2.11	✓	✓	
Z15	✓			●	●	●			121.5	4.78	122.2	4.81	70.0	2.76	55.3	2.18	65.5	2.58	✓	✓	
Z18	✓				●	●	■	■	146.0	5.75	146.3	5.76	70.0	2.76	67.6	2.66	77.5	3.05	✓	✓	
Z19	✓				●	●	■	■	154.2	6.07	154.3	6.07	70.0	2.76	71.7	2.82	81.6	3.21	✓	✓	

■ Molded sprocket

● Molded sprocket

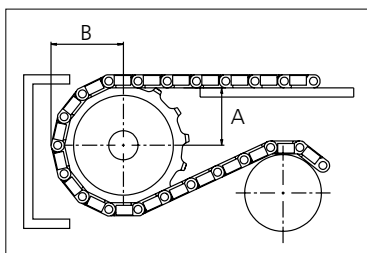
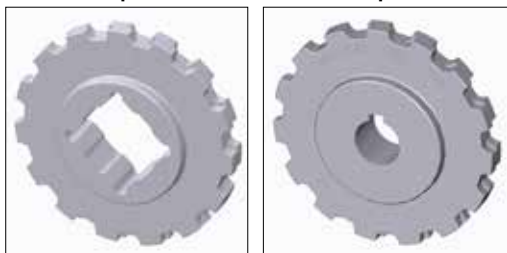

Other sprocket sizes are available upon request.  
 Two-part sprockets are available upon request.  
 Other bore sizes are available upon request.  
 uni Retainer Rings: See uni Retainer Ring data sheet.  
 Width of tooth = 12.0 mm (0.47 in)  
 Width of sprocket = 25.0 mm (0.98 in)

Max load per sprocket shown does not take bore size into account.  
 Please also ensure that sufficient size shaft is chosen for corresponding load.

For correct sprocket position: See uni Assembly Instructions for uni CNB.  
 For more detailed sprocket information, contact Customer Service.

Non standard material and color: See uni Material and Color Overview.



Conveyor Belts



Seamless Belts

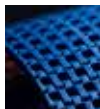

Modular Belts



Timing Belts

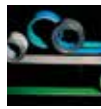

Transmission Belts



Fabrication & service

Expert advice, quality solutions and local service for all your belting needs [www.ammeraalbeltech.com](http://www.ammeraalbeltech.com)

**Ammeraal Beltech Modular A/S**  
Hjulmagervej 21  
DK-7100 Vejle

T +45 7572 3100  
F +45 7572 3348  
admin@unichains.com  
www.unichains.com

This information is subject to alteration due to continuous development. Ammeraal Beltech will not be held liable for the incorrect use of the above stated information. This information replaces previous information. All activities performed and services rendered by Ammeraal Beltech are subject to general terms and conditions of sale and delivery, as applied by its operating companies.



# Plastic Modular Belt

Series **uni CNB** Type **18%**

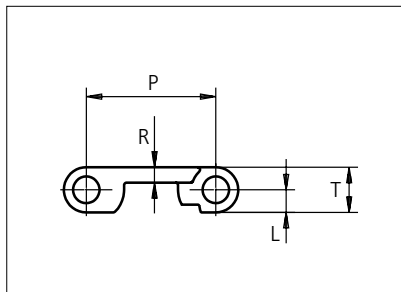

Straight running belt  
 Nominal pitch: 25.4 mm (1.00 in)  
 Surface type: Flat  
 Surface opening: 18%  
 Backflex radius: 40.0 mm (1.60 in)  
 Pin diameter: 5.0 mm (0.20 in)

<b>Belt material &amp; color</b>	PP <b>W</b>	<b>mm</b>	<b>in</b>		<b>mm</b>	<b>in</b>	
<b>Pin material &amp; color</b>	PP <b>W</b>	<b>P (Nominal)</b>	25.4	1.00	<b>T</b>	8.8	0.35
		<b>R</b>	3.0	0.12	<b>L</b>	4.4	0.17

Non standard material and color: See uni Material and Color Overview.

Alternative pin and lock materials: Pin: PE **W** PA6.6 **B** PBT **LG** SS304 Lockpin: PBT **LG** PA6.6 **N** PP **W** **B** PE **N**

Belt width		Permissible tensile force (Belt/pin material)		Belt weight (Belt/pin material)		*Min. No. drive sprocket per shaft	Number of wear strips (Min. No.)	
		PP/PP		PP/PP			**Carry (pcs)	**Return (pcs)
mm	in	N	lbf	kg/m	lb/ft			
77	3.0	539	121	0.3	0.18	2	2	2
153	6.0	1071	241	0.5	0.36	2	2	2
229	9.0	1603	360	0.8	0.54	2	2	2
305	12.0	2135	480	1.1	0.72	3	3	2
381	15.0	2667	600	1.3	0.90	3	3	2
457	18.0	3199	719	1.6	1.07	4	4	2
533	21.0	3731	839	1.9	1.25	4	4	2
609	24.0	4263	958	2.1	1.43	5	5	3
685	27.0	4795	1078	2.4	1.61	5	5	3
761	30.0	5327	1197	2.7	1.79	6	6	3
837	33.0	5859	1317	2.9	1.97	6	6	3
913	35.9	6391	1437	3.2	2.15	7	7	4
989	38.9	6923	1556	3.5	2.33	7	7	4

Additional standard belt widths are available in steps of 76.0 mm (2.99 in). Additional non-standard belt widths are available in steps of 12.7 mm (0.50 in).

1977	77.8	13839	3111	6.9	4.65	14	14	7
------	------	-------	------	-----	------	----	----	---

Additional standard belt widths are available in steps of 76.0 mm (2.99 in). Additional non-standard belt widths are available in steps of 12.7 mm (0.50 in).

2965	116.7	20755	4666	10.4	6.97	20	20	10
------	-------	-------	------	------	------	----	----	----

General belt tolerance is +0/-0.4% at 23°C/73°F and 50% RH. For exact belt width contact Customer Service. Non standard belt width on request.

\*Max. Load per Drive Sprocket. Belt material: PP 500 N (112 lbf)

\*\*Max. Spacing between wear strips, Carry: 152.0 mm (6.00 in); Return: 304.0 mm (12.00 in)

= Single Link



STANDARD

STRAIGHT RUNNING

PITCH 25.4 MM/1.00 IN

## Accessories

### Flight

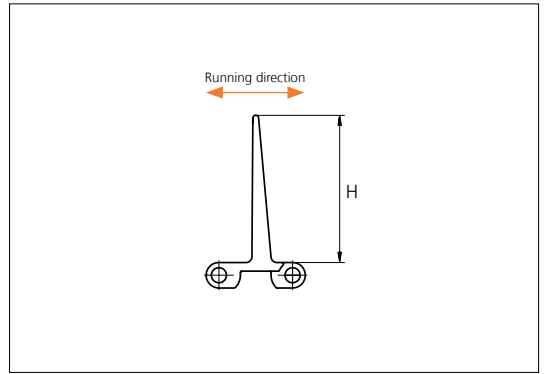
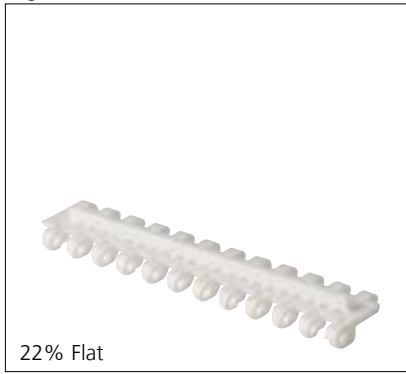

Type	Material & color	H		Link size	Width		Indent	
		mm	in		mm	in	mm	in
22% Flat	PE  PP-I	5.0	0.20	K300	75.9	2.99	6.4	0.25
				K600	152.0	5.98		
Flat/waves	POM-D  PE PP-I  PP-I	25.4	1.00	K600	152.0	5.98	0.0	0.00
		50.8	2.00					
		76.2	3.00					

Minimum bricklaid indent is 38.1 mm (1.50 in). Increment: 12.7 mm (0.50 in).  
 Non Standard material and color: See uni Material and Color Overview.

## Accessories

### Side Guard

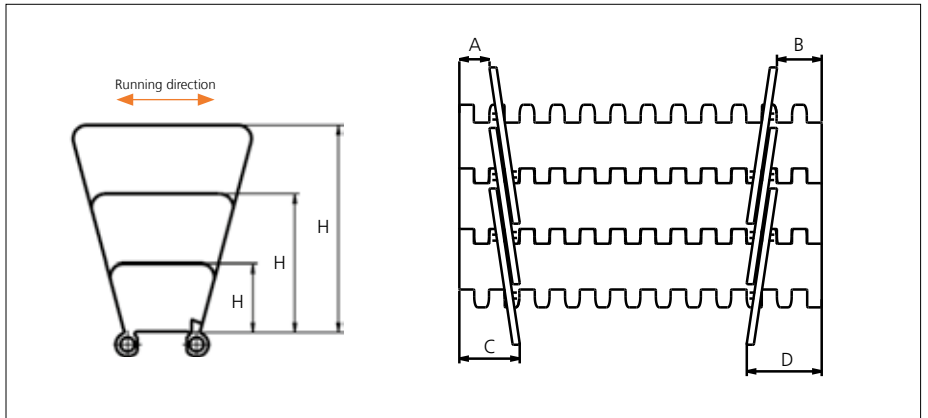

Type	Material & color	H		A (Min.)		B (Min.)		C (Min.)		D (Min.)	
		mm	in	mm	in	mm	in	mm	in	mm	in
Closed	PP-I	25.4	1.00	12.5	0.49	18.5	0.73	25.5	1.00	31.5	1.24
		50.8	2.00								
		76.2	3.00								

Minimum indent to outside of Side Guard: 14.0 mm (0.55 in). Increment 6.4 mm (0.25).  
 Non Standard material and color: See uni Material and Color Overview.  
 Backflex radius for Side Guard: 75.0 mm (2.95 in)

## Sprocket

No of teeth	Bore size								Overall diameter		Pitch diameter		Hub diameter		A-dimension		B-dimension		Double row/Two way	Molded	PA6 LG
	Pilot bore	in		1.00		1.18		1.25													
	mm	25.0	25.4	30.0	31.8	38.1	40.0	mm	in	mm	in	mm	in	mm	in	mm	in				
Z10	✓	●	●	●	●			80.0	3.15	82.2	3.24	70.0	2.76	34.7	1.37	45.5	1.79	✓	✓		
Z12	✓		●	●	●			96.8	3.81	98.1	3.86	70.0	2.76	43.0	1.69	53.5	2.11	✓	✓		
Z15	✓		●	●	●			121.5	4.78	122.2	4.81	70.0	2.76	55.3	2.18	65.5	2.58	✓	✓		
Z18	✓			●	●	■	■	146.0	5.75	146.3	5.76	70.0	2.76	67.6	2.66	77.5	3.05	✓	✓		
Z19	✓			●	●	■	■	154.2	6.07	154.3	6.07	70.0	2.76	71.7	2.82	81.6	3.21	✓	✓		

■ Molded sprocket

● Molded sprocket

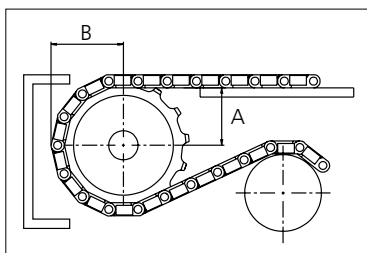
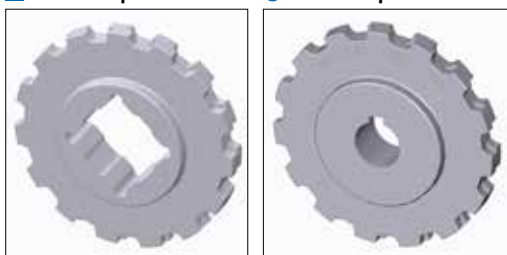

Other sprocket sizes are available upon request.

Two-part sprockets are available upon request..

Other bore sizes are available upon request.

uni Retainer Rings: See uni Retainer Ring data sheet.

Width of tooth = 12.0 mm (0.47 in)

Width of sprocket = 25.0 mm (0.98 in)

Max load per sprocket shown does not take bore size into account.

Please also ensure that sufficient size shaft is chosen for corresponding load.

For correct sprocket position: See uni Assembly Instructions for uni CNB.

For more detailed sprocket information, contact Customer Service.

Non standard material and color: See uni Material and Color Overview.



Conveyor Belts



Seamless Belts



Modular Belts



Timing Belts

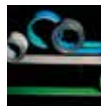

Transmission Belts



Fabrication & service

Expert advice, quality solutions and local service for all your belting needs [www.ammeraalbeltech.com](http://www.ammeraalbeltech.com)

**Ammeraal Beltech Modular A/S**  
Hjulmagervej 21  
DK-7100 Vejle

T +45 7572 3100  
F +45 7572 3348  
admin@unichains.com  
www.unichains.com

This information is subject to alteration due to continuous development. Ammeraal Beltech will not be held liable for the incorrect use of the above stated information. This information replaces previous information. All activities performed and services rendered by Ammeraal Beltech are subject to general terms and conditions of sale and delivery, as applied by its operating companies.



# Plastic Modular Belt

Series **uni CNB** Type **22%**

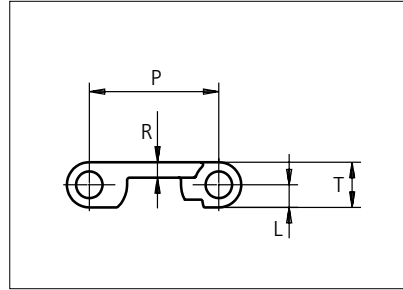
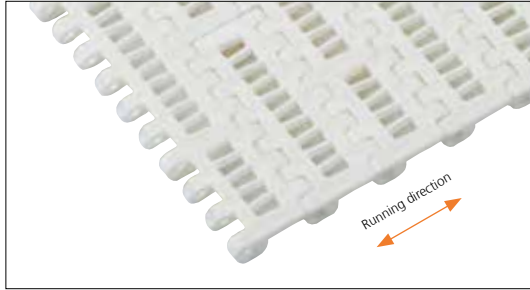

Straight running belt  
 Nominal pitch: 25.4 mm (1.00 in)  
 Surface type: Flat  
 Surface opening: 22%  
 Backflex radius: 40.0 mm (1.60 in)  
 Pin diameter: 5.0 mm (0.20 in)

Belt material & color	PP <b>W</b>	POM-D <b>W</b>	PE <b>N</b>	mm	in	mm	in		
Pin material & color	PP <b>W</b>		PE <b>N</b>	P (Nominal)	25.4	1.00	T	8.8	0.35
				R	3.0	0.12	L	4.4	0.17

Non standard material and color: See uni Material and Color Overview.

Alternative pin and lock materials: Pin: PE **W** PA6.6 **B** PBT **LG** SS304 Lockpin: PBT **LG** PA6.6 **N** PP **W** **B** PE **N**

Belt width		Permissible tensile force (Belt/pin material)						Belt weight (Belt/pin material)						*Min. No. drive sprocket per shaft	Number of wear strips (Min. No.)	
		POM-D/PA6.6		PP/PA6.6		PE/PA6.6		POM-D/PA6.6		PP/PA6.6		PE/PA6.6			**Carry (pcs)	**Return (pcs)
mm	in	N	lbf	N	lbf	N	lbf	kg/m	lb/ft	kg/m	lb/ft	kg/m	lb/ft			
77	3.0	1040	234	539	121	477	107	0.4	0.25	0.3	0.18	0.3	0.18	2	2	2
153	6.0	2065	464	1071	241	949	213	0.7	0.49	0.5	0.35	0.5	0.36	2	2	2
229	9.0	3091	695	1603	360	1420	319	1.1	0.74	0.8	0.52	0.8	0.54	2	2	2
305	12.0	4117	926	2135	480	1891	425	1.5	0.98	1.0	0.70	1.1	0.72	3	3	2
381	15.0	5143	1156	2667	600	2362	531	1.8	1.23	1.3	0.87	1.3	0.90	3	3	2
457	18.0	6169	1387	3199	719	2833	637	2.2	1.47	1.6	1.04	1.6	1.07	4	4	2
533	21.0	7195	1617	3731	839	3304	743	2.6	1.72	1.8	1.22	1.9	1.25	4	4	2
609	24.0	8221	1848	4263	958	3776	849	2.9	1.96	2.1	1.39	2.1	1.43	5	5	3
685	27.0	9247	2079	4795	1078	4247	955	3.3	2.21	2.3	1.57	2.4	1.61	5	5	3
761	30.0	10273	2309	5327	1197	4718	1061	3.7	2.45	2.6	1.74	2.7	1.79	6	6	3
837	33.0	11299	2540	5859	1317	5189	1167	4.0	2.70	2.8	1.91	2.9	1.97	6	6	3
913	35.9	12325	2771	6391	1437	5660	1272	4.4	2.95	3.1	2.09	3.2	2.15	7	7	4
989	38.9	13351	3001	6923	1556	6132	1378	4.7	3.19	3.4	2.26	3.5	2.33	7	7	4

Additional standard belt widths are available in steps of 76.0 mm (2.99 in.) Additional non-standard belt widths are available in steps of 12.7 mm (0.50 in.)

1977	77.8	26690	6000	13839	3111	12257	2755	9.5	6.38	6.7	4.52	6.9	4.65	14	14	7
------	------	-------	------	-------	------	-------	------	-----	------	-----	------	-----	------	----	----	---

Additional standard belt widths are available in steps of 76.0 mm (2.99 in.) Additional non-standard belt widths are available in steps of 12.7 mm (0.50 in.)

2965	116.7	40028	8998	20755	4666	18383	4132	14.2	9.56	10.1	6.77	10.4	6.97	20	20	10
------	-------	-------	------	-------	------	-------	------	------	------	------	------	------	------	----	----	----

General belt tolerance is +0/-0.4% at 23°C/73°F and 50% RH. For exact belt width contact Customer Service. Non standard belt width on request.

\*Max. Load per Drive Sprocket. Belt material: POM-D 600 N (135 lbf), PP 500 N (112 lbf)

\*\*Max. Spacing between wear strips, Carry: 152.0 mm (6.00 in); Return: 304.0 mm (12.00 in)

= Single Link



STANDARD

STRAIGHT RUNNING

PITCH 25.4 MM/1.00 IN

## Accessories

### Flight

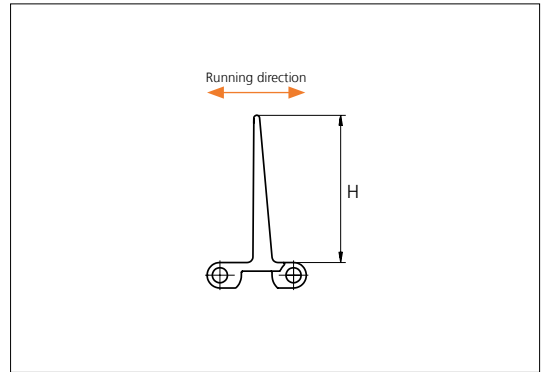
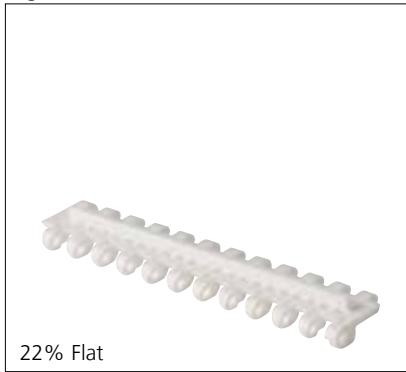

Type	Material & color	H		Link size	Width		Indent	
		mm	in		mm	in	mm	in
22% Flat	PE  PP-I	5.0	0.20	K300	75.9	2.99	6.4	0.25
				K600	152.0	5.98		
Flat/waves	POM-D  PE PP-I  PP-I	25.4	1.00	K600	152.0	5.98	0.0	0.00
		50.8	2.00					
		76.2	3.00					

Minimum bricklaid indent is 38.1 mm (1.50 in). Increment: 12.7 mm (0.50 in).  
 Non Standard material and color: See uni Material and Color Overview.

## Accessories

### Side Guard

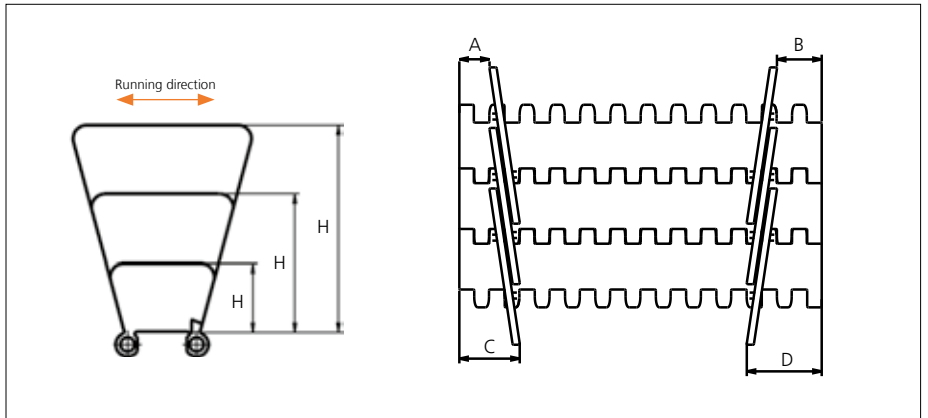

Type	Material & color	H		A (Min.)		B (Min.)		C (Min.)		D (Min.)	
		mm	in	mm	in	mm	in	mm	in	mm	in
Closed	PP-I	25.4	1.00	12.5	0.49	18.5	0.73	25.5	1.00	31.5	1.24
		50.8	2.00								
		76.2	3.00								

Minimum indent to outside of Side Guard: 14.0 mm (0.55 in). Increment 6.4 mm (0.25).  
 Non Standard material and color: See uni Material and Color Overview.  
 Backflex radius for Side Guard: 75.0 mm (2.95 in)



## Sprocket

No of teeth	Bore size								Overall diameter		Pitch diameter		Hub diameter		A-dimension		B-dimension		Double row/Two way	Molded	PA6 LG
	Pilot bore	in	0.98	1.00	1.18	1.25	1.50	1.57													
	mm	25.0	25.4	30.0	31.8	38.1	40.0	mm	in	mm	in	mm	in	mm	in	mm	in				
Z10	✓		●	●	●	●			80.0	3.15	82.2	3.24	70.0	2.76	34.7	1.37	45.5	1379	✓	✓	
Z12	✓			●	●	●			96.8	3.81	98.1	3.86	70.0	2.76	43.0	1.69	53.5	2.11	✓	✓	
Z15	✓			●	●	●			121.5	4.78	122.2	4.81	70.0	2.76	55.3	2.18	65.5	2.58	✓	✓	
Z18	✓				●	●	■	■	146.0	5.75	146.3	5.76	70.0	2.76	67.6	2.66	77.5	3.05	✓	✓	
Z19	✓				●	●	■	■	154.2	6.07	154.3	6.07	70.0	2.76	71.7	2.82	81.6	3.21	✓	✓	

■ Molded sprocket

● Molded sprocket

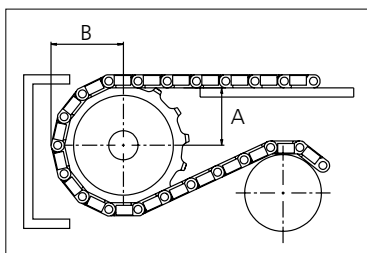
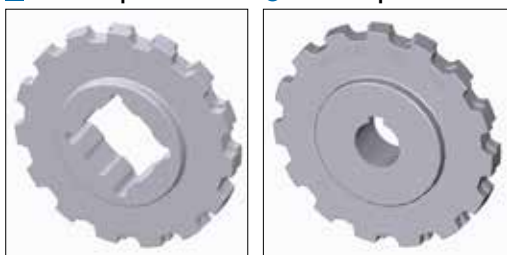

Other sprocket sizes are available upon request.  
 Two-part sprockets are available upon request.  
 Other bore sizes are available upon request.  
 uni Retainer Rings: See uni Retainer Ring data sheet.  
 Width of tooth = 12.0 mm (0.47 in)  
 Width of sprocket = 25.0 mm (0.98 in)

Max load per sprocket shown does not take bore size into account.  
 Please also ensure that sufficient size shaft is chosen for corresponding load.

For correct sprocket position: See uni Assembly Instructions for uni CNB.  
 For more detailed sprocket information, contact Customer Service.

Non standard material and color: See uni Material and Color Overview.



Conveyor Belts



Seamless Belts

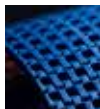

Modular Belts



Timing Belts

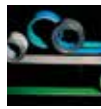

Transmission Belts



Fabrication & service

Expert advice, quality solutions and local service for all your belting needs [www.ammeraalbeltech.com](http://www.ammeraalbeltech.com)

**Ammeraal Beltech Modular A/S**  
Hjulmagervej 21  
DK-7100 Vejle

T +45 7572 3100  
F +45 7572 3348  
admin@unichains.com  
www.unichains.com

This information is subject to alteration due to continuous development. Ammeraal Beltech will not be held liable for the incorrect use of the above stated information. This information replaces previous information. All activities performed and services rendered by Ammeraal Beltech are subject to general terms and conditions of sale and delivery, as applied by its operating companies.



# Plastic Modular Belt

Series **uni CPB** Type **C**

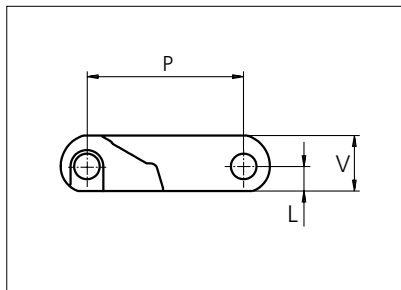

Straight running belt  
 Nominal pitch: 50.8 mm (2.00 in)  
 Surface type: Flat  
 Surface opening: Closed  
 Backflex radius: 85.0 mm (3.30 in)  
 Pin diameter: 8.0 mm (0.31 in)

Belt material & color	POM-NL <b>K</b>	PP <b>G</b>	mm	in	mm	in		
			<b>P (Nominal)</b>	50.8	2.00	<b>V</b>	19.0	0.75
Pin material & color	PA6.6 <b>N</b>		<b>L</b>	8.0	0.31	-	-	-

Non standard material and color: See uni Material and Color Overview.  
 Alternative pin and lock systems and materials: Contact Customer Service.

Belt width		Permissible tensile force (Belt/pin material)				Belt weight (Belt/pin material)				*Min. No. drive sprocket per shaft	Number of wear strips (Min. No.)	
		POM-NL / PA6.6		PP/PA6.6		POM-NL / PA6.6		PP/PA6.6			**Carry (pcs)	**Return (pcs)
mm	in	N	lbf	N	lbf	kg/m	lb/ft	kg/m	lb/ft			
151	5.9	7852	1765	5285	1188	2.5	1.68	1.7	1.13	2	2	2
202	8.0	10504	2361	7070	1589	3.4	2.25	2.2	1.51	2	2	2
252	9.9	13104	2946	8820	1983	4.2	2.81	2.8	1.88	2	2	2
302	11.9	15704	3530	10570	2376	5.0	3.37	3.4	2.25	3	3	2
352	13.9	18304	4115	12320	2770	5.8	3.93	3.9	2.63	3	3	2
403	15.9	20956	4711	14105	3171	6.7	4.50	4.5	3.01	3	3	2
453	17.8	23556	5295	15855	3564	7.5	5.05	5.0	3.38	4	4	2
503	19.8	26156	5880	17605	3958	8.3	5.61	5.6	3.75	4	4	2
553	21.8	28756	6464	19355	4351	9.2	6.17	6.1	4.13	4	4	2
604	23.8	31408	7061	21140	4752	10.0	6.74	6.7	4.51	5	5	3
654	25.7	34008	7645	22890	5146	10.9	7.30	7.3	4.88	5	5	3
704	27.7	36608	8229	24640	5539	11.7	7.85	7.8	5.25	5	5	3
754	29.7	39208	8814	26390	5932	12.5	8.41	8.4	5.62	6	6	3

Additional standard belt widths are available in steps of 50.3 mm (1.98 in). Additional non-standard belt widths are available in steps of mm 16.8 (0.66 in).

1961	77.2	101972	22923	68635	15429	32.6	21.88	21.8	14.63	14	14	7
------	------	--------	-------	-------	-------	------	-------	------	-------	----	----	---

Additional standard belt widths are available in steps of 50.3 mm (1.98 in). Additional non-standard belt widths are available in steps of mm 16.8 (0.66 in).

2966	116.8	154232	34671	103810	23336	49.2	33.09	32.9	22.13	20	20	10
------	-------	--------	-------	--------	-------	------	-------	------	-------	----	----	----

General belt tolerance is +0/-0.4% at 23°C/73°F and 50% RH. For exact belt width contact Customer Service. Non standard belt width on request.

\*Max. Load per Drive Sprocket. Belt material: POM-NL 2500 N (560 lbf). PP 2500 N (560 lbf).

\*\*Max. Spacing between wear strips. Carry: 152.0 mm (6.00 in); Return: 304.0 mm (12.00 in).

= Single Link



STANDARD

STRAIGHT RUNNING

PITCH 50.8 MM/2.00 IN

## Accessories

### Rubber Top

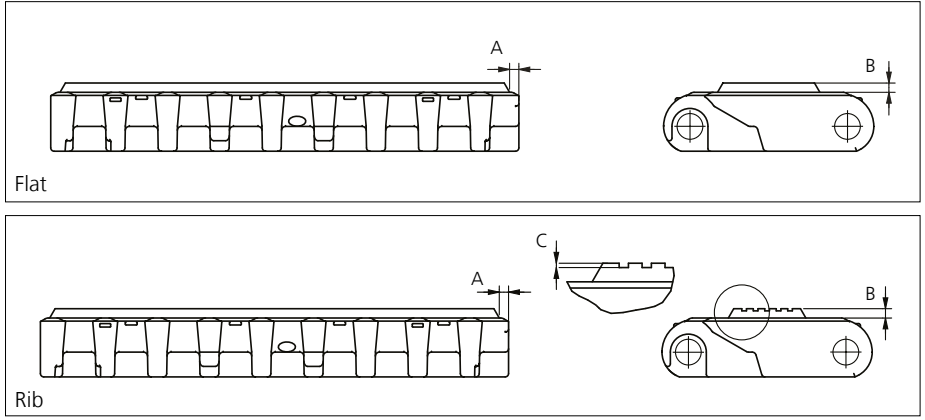

Type	Belt material & color	Rubber material & color	A		B		C		Link size	Width	
			mm	in	mm	in	mm	in		mm	in
Flat	POM-NL <b>K</b>	09 <b>K</b>	2.5	0.09	3.0	0.12	0.7	0.02	K600	150.5	5.93
Rib											

The color of standard rubber material is black. However, as it is hardly possible to see black rubber on black links, the links are illustrated with rubber in color natural. Other Non Standard Rubber profiles: See uni Rubber Profile Overview.

## Accessories

### Flight

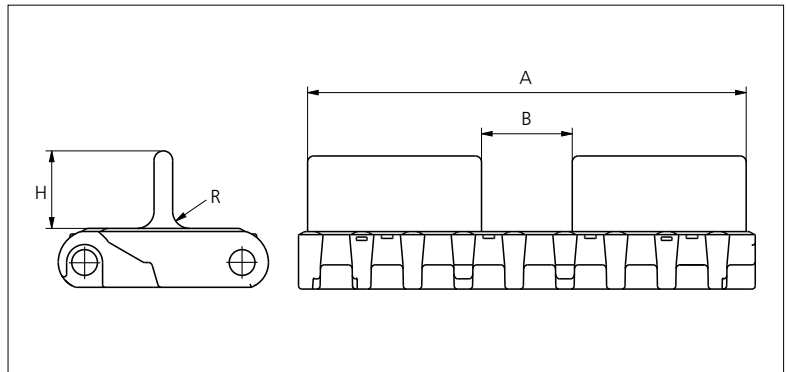

Type	Material & color	H		R		A		B		Link size	Width		Indent	
		mm	in	mm	in	mm	in	mm	in		mm	in	mm	in
Flat	POM-NL <b>K</b>	25.0	0.98	5.5	0.22	145.0	5.70	30.0	1.18	K600	150.5	5.93	2.8	0.11

Non Standard material and color: See uni Material and Color Overview.

## Accessories

### Top/Bottom Insert NON STANDARD



The thread inserts allow for easy attachment of fixturers to the belt. Available insert size M5 + M6.

Depending on the size and shape of the attachment, attention should be paid as to how it will influence on the backflex radius of the belt.

## Accessories

### AmFlight

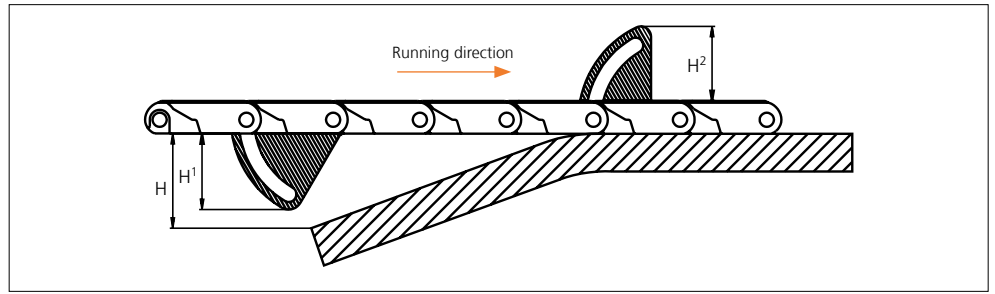
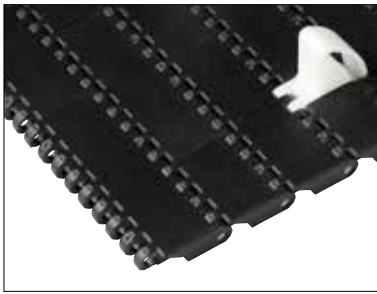

Type	Material & color	H		H <sup>1</sup>		H <sup>2</sup>	
		mm	in	mm	in	mm	in
Pull	PE <b>W</b>	56.2	1.21	45.0	1.77	45.6	1.80

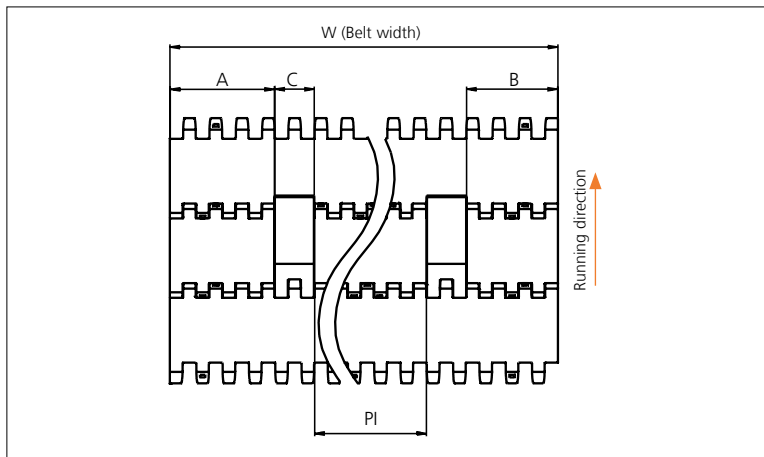

	mm	in
<b>A min</b>	67.7	2.67
<b>B min</b>	59.3	2.33
<b>C</b>	24.0	0.94
<b>PI max</b>	W - 175.0	W - 6.89
<b>PI min</b>	43.2	1.70

Increment: 17.0 mm (0.70 in.)

## Sprocket

No of teeth	Bore size										Overall diameter		Pitch-diameter		Hub-diameter		Dimension A		Dimension B		Single row/One way	Double row/Two way	Molded PA6 LG	Machined PA6 N
	Pilot bore		1.00		1.18		1.25		1.50															
	mm	in	25.4	30.0	31.8	38.1	40.0	60.0	63.5	90.0	mm	in	mm	in	mm	in	mm	in	mm	in				
Z06	✓	●	●	●	■	●	■				99.5	3.92	101.6	4.00	65.0	2.56	36.0	1.42	59.3	2.33	✓		✓	
Z08	✓	●	●	●	■	●	■	■			132.9	5.23	132.8	5.23	70.0	2.75	53.3	2.10	74.9	2.94	✓	1	✓	
Z10	✓		1	1	1	1	1	2	2		166.3	6.55	164.4	6.47	<sup>1</sup> 70.0 <sup>2</sup> 120.0	2.75 4.72	70.2	2.76	90.7	3.57	✓	✓	✓	
Z12	✓		1	1	1	1	1	2	2	3	198.6	7.82	196.3	7.73	<sup>1</sup> 70.0 <sup>2</sup> 120.0 <sup>3</sup> 164.0	2.75 4.72 6.45	86.8 86.8	3.42 3.42	106.6 106.6	4.19 4.19	<sup>1+2</sup> ✓	<sup>2+3</sup> ✓	✓	
Z16	✓		2	2	2	2	2	3	2	3	263.8	10.39	260.4	10.25	<sup>1</sup> 150.0 <sup>2</sup> 164.0 <sup>3</sup> 200.0	5.90 6.45 7.87	119.7	4.71	138.7	5.46	1	<sup>2+3</sup> ✓	✓	✓

● Molded sprocket    ■ Molded sprocket    ■ Machined sprocket



Other sprocket sizes are available upon request.  
 Other bore sizes on sprockets are available upon request.  
 Round bores are always delivered with keyway.  
 Max. load per sprocket shown does not take bore size into account.  
 Please also ensure that sufficient size shaft is chosen for corresponding load.  
 Width of tooth = Single row: 9.5 mm (0.37 in)  
 = Double row: 17.8 mm (0.70 in)  
 Width of One-part sprocket = Single row: 42.3 mm (1.66 in)  
 = Double row: 42.3 mm (1.66 in)  
 = <sup>3</sup>Double row: 50.0 mm (1.96 in)

## uni UltraClean Two-Part Sprocket

No. of teeth	Bore size				Overall diameter		Pitch-diameter		Hub-diameter		Dimension A		Dimension B		Single row/One way	Moulded PA6 W
	in	1.50	1.57	2.36												
	mm	38.1	40.0	60.0	mm	in	mm	in	mm	in	mm	in	mm	in		
Z8		■	■		132.9	5.23	132.8	5.23	80.0	3.15	53.3	2.10	74.9	2.94	✓	✓
Z10		1	1	2	166.3	6.55	164.4	6.47	<sup>1</sup> 126.0 <sup>2</sup> 118.0	<sup>1</sup> 4.96 <sup>2</sup> 4.65	70.2	2.76	90.7	3.57	✓	✓
Z12		1	1	2	198.6	7.82	196.3	7.73	<sup>1</sup> 126.0 <sup>2</sup> 118.0	<sup>1</sup> 4.96 <sup>2</sup> 4.65	86.8	3.42	106.6	4.19	✓	✓

■ Moulded uni UltraClean TwoPart Sprocket

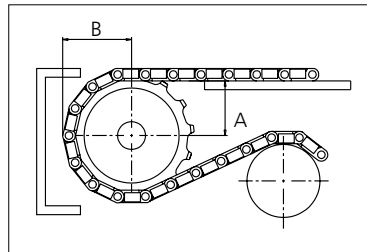

Width of UltraClean Two-part sprocket = Single row: 44.0 mm (1.73 in)  
 Width of UltraClean Two-part sprocket, tooth = Single row: 9.5 mm (0.37 in)

uni Retainer Rings: See uni Retainer Ring data sheet.  
 For correct sprocket position: See uni Assembly Instructions for uni CPB.  
 For more detailed sprocket information, contact Customer Service.



Expert advice, quality solutions and local service for all your belting needs  
[www.ammeraalbeltech.com](http://www.ammeraalbeltech.com)

**Ammeraal Beltech Modular A/S**  
 Hjulmagervej 21  
 DK-7100 Vejle

T +45 7572 3100  
 F +45 7572 3348  
 admin@unichains.com  
 www.unichains.com

This information is subject to alteration due to continuous development. Ammeraal Beltech will not be held liable for the incorrect use of the above stated information. This information replaces previous information. All activities performed and services rendered by Ammeraal Beltech are subject to general terms and conditions of sale and delivery, as applied by its operating companies.



# Plastic Modular Belt

Series **uni CPB** Type **Rough Embedded**

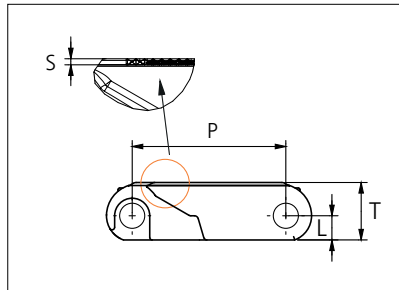

Straight running belt  
 Nominal pitch: 50.8 mm (2.00 in)  
 Surface type: Rough Embedded  
 Surface opening: 0%  
 Backflex radius: 85.0 mm (3.30 in)  
 Pin diameter: 8.0 mm (0.31 in)

<b>Belt material &amp; color</b>	POM-DI UV <span style="background-color: orange; border: 1px solid black; padding: 0 2px;">O</span> <span style="background-color: white; border: 1px solid black; padding: 0 2px;">W</span>		<b>mm</b>	<b>in</b>		<b>mm</b>	<b>in</b>	
<b>Pin and lock material &amp; color</b>	PBT-GR <span style="background-color: black; color: white; padding: 0 2px;">N</span>	PA6.6 <span style="background-color: black; color: white; padding: 0 2px;">N</span>	<b>P (Nominal)</b>	50.8	2.00	<b>S</b>	1.0	0.04
			<b>L</b>	8.0	0.31	<b>T</b>	18.0	0.71

Non standard material and color: See uni Material and Color Overview.

Belt width		Permissible tensile force (Belt/pin material)		Belt weight (Belt/pin material)		*Min. No. drive sprocket per shaft	Number of wear strips (Min. No.)	
		POM-DI UV/PBT-GR		POM-DI UV/PBT-GR			**Carry (pcs)	**Return (pcs)
mm	in	N	lbf	kg/m	lb/ft			
151	5.9	7826	1759	2.5	1.68	2	2	2
403	15.9	20956	4711	6.7	4.50	3	3	2
453	17.8	23556	5295	7.5	5.05	4	4	2
503	19.8	26156	5880	8.3	5.61	4	4	2
553	21.8	28756	6464	9.2	6.17	4	4	2
604	23.8	31408	7061	10.0	6.74	5	5	3
654	25.7	34008	7645	10.9	7.30	5	5	3
704	27.7	36608	8229	11.7	7.85	5	5	3
754	29.7	39208	8814	12.5	8.41	6	6	3
805	31.7	41860	9410	13.4	8.98	6	6	3
855	33.7	44460	9995	14.2	9.54	6	6	3
905	35.6	47060	10579	15.0	10.10	7	7	4
956	37.6	49712	11175	15.9	10.67	7	7	4

Additional standard belt widths are available in steps of 50.3 mm (1.98 in). Additional non-standard belt widths are available in steps of 16.8 mm (0.66 in).

1961	77.2	101972	22923	32.6	21.88	14	14	7
------	------	--------	-------	------	-------	----	----	---

Additional standard belt widths are available in steps of 50.3 mm (1.98 in). Additional non-standard belt widths are available in steps of 16.8 mm (0.66 in).

2966	116.8	154232	34671	49.2	33.09	20	20	10
------	-------	--------	-------	------	-------	----	----	----

General belt tolerance is +0/-0.4% at 23°C/73°F and 50% RH. For exact belt width contact Customer Service. Non standard belt width on request.

\*Max. Load per Drive Sprocket. Belt material: POM-NLAS 2500 N (560 lbf), POM-NL 2500 N (560 lbf), PP 2500 N (560 lbf).

\*\*Max. Spacing between wear strips, Carry: 152.0 mm (6.00 in); Return: 304.0 mm (12.00 in).

= Single Link



STANDARD

STRAIGHT RUNNING

PITCH 50.8 MM/2.00 IN

## Accessories

### Rubber Top

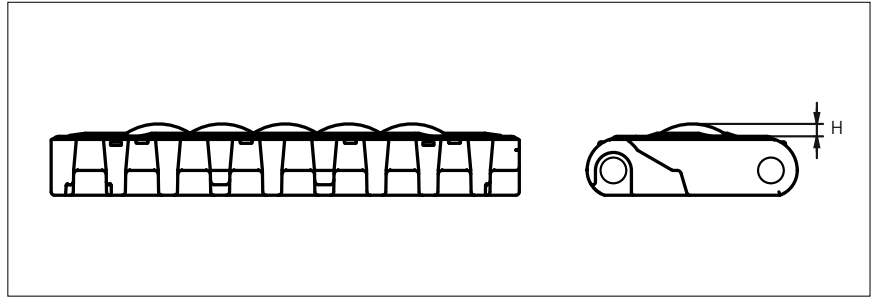

Type	Belt material & color	Rubber material & color	H		Link size	Width	
			mm	in		mm	in
Dome	PPI/UV <b>W</b>	03K <b>K</b>	4.0	0.16	K600	150.5	5.93

### Sprocket

No of teeth	Bore size					Overall diameter		Pitch diameter		Hub diameter		Dimension A		Dimension B		Single row/One way	Double row/Two way	Molded PA6 LG	Machined PA6 N
	in	1.57	2.36	2.50	3.54														
	mm	40.0	60.0	63.5	90.0	mm	in	mm	in	mm	in	mm	in						
Z16			■		■	263.8	10.39	260.4	10.25	160	6.29	119.7	4.71	138.7	5.46		x	x	

#### ■ Molded sprocket

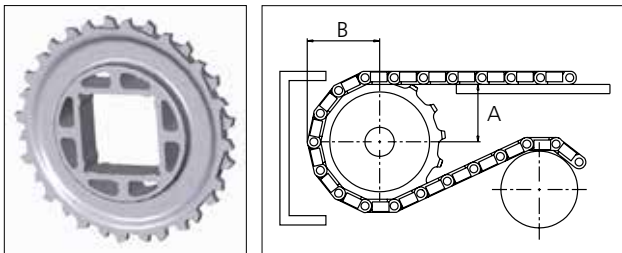

Non standard material and color: See uni Material and Color Overview.

Other sprocket sizes are available upon request.  
 Two-part sprocket are available upon request.  
 Round bores are always delivered with keyway.  
 Other bore sizes are available upon request.  
 uni Retainer Rings: See uni Retainer Ring data sheet.  
 Width of tooth = 9.5 mm (0.37 in)  
 Width of sprocket = 40.8.0 mm (1.60 in)

Max load per sprocket shown does not take bore size into account.  
 Please also ensure that sufficient size shaft is chosen for corresponding load.

For correct sprocket position: See uni Assembly Instructions for uni CPB.  
 For more detailed sprocket information, contact Customer Service.

uni CPB Rough Embedded/161220



Expert advice, quality solutions and local service for all your belting needs  
[www.ammeraalbeltech.com](http://www.ammeraalbeltech.com)

**Ammeraal Beltech Modular A/S**  
 Hjulmagervej 21  
 DK-7100 Vejle

T +45 7572 3100  
 F +45 7572 3348  
 admin@unichains.com  
 www.unichains.com

This information is subject to alteration due to continuous development. Ammeraal Beltech will not be held liable for the incorrect use of the above stated information. This information replaces previous information. All activities performed and services rendered by Ammeraal Beltech are subject to general terms and conditions of sale and delivery, as applied by its operating companies.





# Plastic Modular Belt

Series **uni CPB** Type **20% Rough**

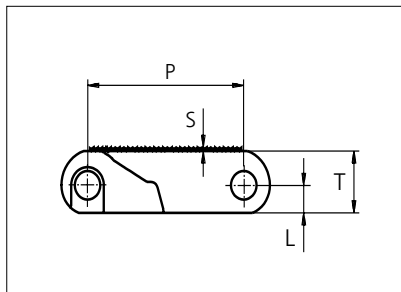

Straight running belt  
 Nominal pitch: 50.8 mm (2.00 in)  
 Surface type: Rough Top  
 Surface opening: 20%  
 Backflex radius: 85.0 mm (3.30 in)  
 Pin diameter: 8.0 mm (0.31 in)

Belt material & color	POM-NL <b>K</b>		mm	in		mm	in
		<b>P (Nominal)</b>	50.8	2.00	<b>S</b>	1.0	0.04
Pin material & color	PA6.6 <b>N</b>						
		<b>L</b>	8.0	0.31	<b>T</b>	18.0	0.71

Non standard material and color: See uni Material and Color Overview.  
 Alternative pin and lock systems and materials: Contact Customer Service.

Belt width		Permissible tensile force (Belt/pin material)		Belt weight (Belt/pin material)		*Min. No. drive sprocket per shaft	Number of wear strips (Min. No.)	
		POM-NL / PA6.6		POM-NL / PA6.6			**Carry (pcs)	**Return (pcs)
mm	in	N	lbf	kg/m	lb/ft			
151	5.9	7852	1765	2.5	1.68	2	2	2
202	8.0	10504	2361	3.4	2.25	2	2	2
252	9.9	13104	2946	4.2	2.81	2	2	2
302	11.9	15704	3530	5.0	3.37	3	3	2
352	13.9	18304	4115	5.8	3.93	3	3	2
403	15.9	20956	4711	6.7	4.50	3	3	2
453	17.8	23556	5295	7.5	5.05	4	4	2
503	19.8	26156	5880	8.3	5.61	4	4	2
553	21.8	28756	6464	9.2	6.17	4	4	2
604	23.8	31408	7061	10.0	6.74	5	5	3
654	25.7	34008	7645	10.9	7.30	5	5	3
704	27.7	36608	8229	11.7	7.85	5	5	3
754	29.7	39208	8814	12.5	8.41	6	6	3

Additional standard belt widths are available in steps of 50.3 mm (1.98 in). Additional non-standard belt widths are available in steps of mm 16.8 (0.66 in).

1961	77.2	101972	22923	32.6	21.88	14	14	7
------	------	--------	-------	------	-------	----	----	---

Additional standard belt widths are available in steps of 50.3 mm (1.98 in). Additional non-standard belt widths are available in steps of mm 16.8 (0.66 in).

2966	116.8	154232	34671	49.2	33.09	20	20	10
------	-------	--------	-------	------	-------	----	----	----

General belt tolerance is +0/-0.4% at 23°C/73°F and 50% RH. For exact belt width contact Customer Service. Non standard belt width on request.

\*Max. Load per Drive Sprocket. Belt material: POM-NL 2500 N (560 lbf). PP 2500 N (560 lbf).

\*\*Max. Spacing between wear strips. Carry: 152.0 mm (6.00 in); Return: 304.0 mm (12.00 in).

= Single Link



STANDARD

STRAIGHT RUNNING

PITCH 50.8 MM/2.00 IN

## Accessories

### Rubber Top

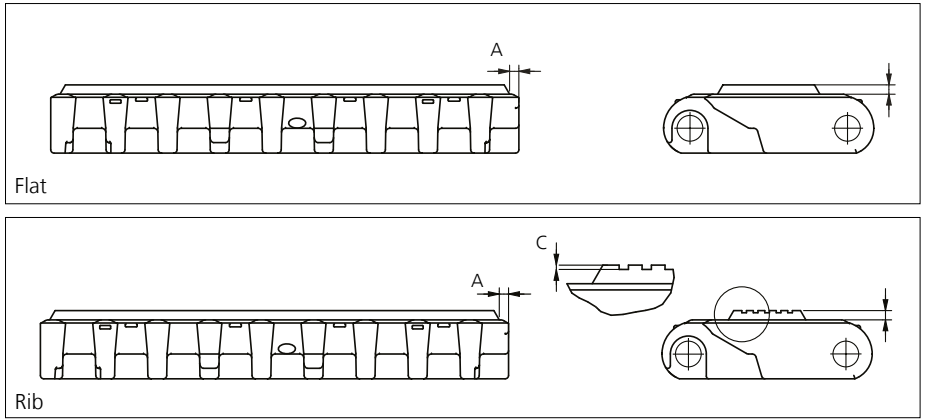

Type	Belt material & color	Rubber material & color	A		B		C		Link size	Width	
			mm	in	mm	in	mm	in		mm	in
Flat	POM-NL <b>K</b>	09 <b>K</b>	2.5	0.09	3.0	0.12	0.7	0.02	K600	150.5	5.93
Rib											

The color of standard rubber material is black. However, as it is hardly possible to see black rubber on black links, the links are illustrated with rubber in color natural. Other Non Standard Rubber profiles: See uni Rubber Profile Overview.

## Accessories

### Flight

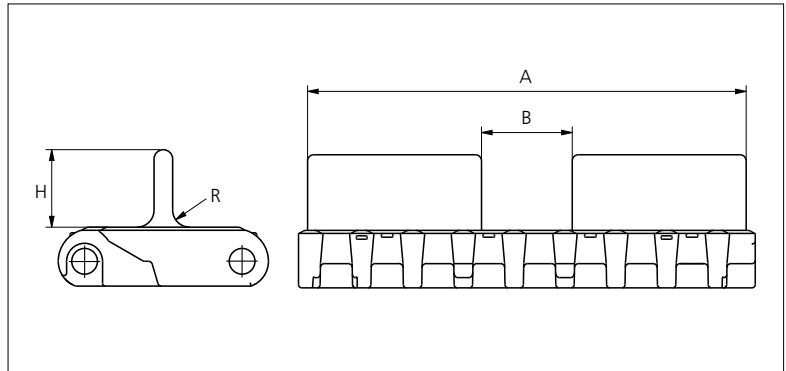

Type	Material & color	H		R		A		B		Link size	Width		Indent	
		mm	in	mm	in	mm	in	mm	in		mm	in	mm	in
Flat	POM-NL <b>K</b>	25.0	0.98	5.5	0.22	145.0	5.70	30.0	1.18	K600	150.5	5.93	2.8	0.11

Non Standard material and color: See uni Material and Color Overview.

## Accessories

### Top/Bottom Insert NON STANDARD



The thread inserts allow for easy attachment of fixturers to the belt.  
 Available insert size M5 + M6.  
 Depending on the size and shape of the attachment, attention should be paid as to how it will influence on the backflex radius of the belt.

## Accessories

### Non Standard uni AmFlight

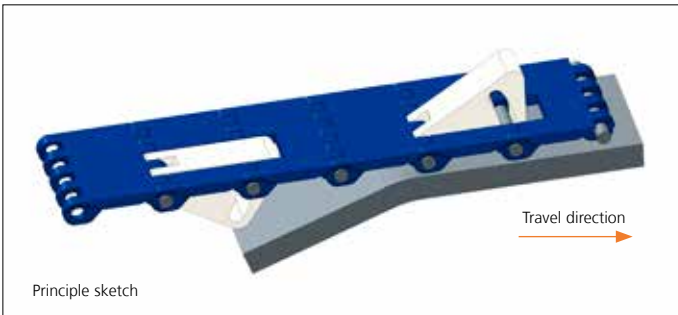

## Sprocket

No of teeth	Bore size										Overall diameter		Pitch-diameter		Hub-diameter		Dimension A		Dimension B		Single row/One way	Double row/Two way	Molded PA6 LG	Machined PA6 N
	Pilot bore		1.00		1.18		1.25		1.50															
	mm	in	25.4	30.0	31.8	38.1	40.0	60.0	63.5	90.0	mm	in	mm	in	mm	in	mm	in						
Z06	✓	●	●	●	■	●	■				99.5	3.92	101.6	4.00	65.0	2.56	36.0	1.42	59.3	2.33	✓		✓	
Z08	✓	●	●	●	■	●	■	■			132.9	5.23	132.8	5.23	70.0	2.75	53.3	2.10	74.9	2.94	✓	1✓	✓	
Z10	✓		1●	1●	1●	1●	1●	2■	2■		166.3	6.55	164.4	6.47	<sup>1</sup> 70.0 <sup>2</sup> 120.0	2.75 4.72	70.2	2.76	90.7	3.57	✓	✓	✓	
Z12	✓		1●	1●	1●	1●	1●	2■	2■	3■	198.6	7.82	196.3	7.73	<sup>1</sup> 70.0 <sup>2</sup> 120.0 <sup>3</sup> 164.0	2.75 4.72 6.45	86.8 86.8	3.42 3.42	106.6 106.6	4.19 4.19	<sup>1+2</sup> ✓	<sup>2+3</sup> ✓	✓	
Z16	✓		2● 1●	2● 1●	2● 1●	2● 1●	2● 1●	3■ 1●	2■ 1●	3■	263.8	10.39	260.4	10.25	<sup>1</sup> 150.0 <sup>2</sup> 164.0 <sup>3</sup> 200.0	5.90 6.45 7.87	119.7	4.71	138.7	5.46	1✓	<sup>2+3</sup> ✓	✓	✓

● Molded sprocket    ■ Molded sprocket    ■ Machined sprocket



Other sprocket sizes are available upon request.  
 Other bore sizes on sprockets are available upon request.  
 Round bores are always delivered with keyway.  
 Max. load per sprocket shown does not take bore size into account.  
 Please also ensure that sufficient size shaft is chosen for corresponding load.  
 Width of tooth = Single row: 9.5 mm (0.37 in)  
 = Double row: 17.8 mm (0.70 in)  
 Width of One-part sprocket = Single row: 42.3 mm (1.66 in)  
 = Double row: 42.3 mm (1.66 in)  
 = <sup>3</sup>Double row: 50.0 mm (1.96 in)

## uni UltraClean Two-Part Sprocket

No. of teeth	Bore size				Overall diameter		Pitch-diameter		Hub-diameter		Dimension A		Dimension B		Single row/One way	Moulded PA6 W
	in	1.50	1.57	2.36												
	mm	38.1	40.0	60.0	mm	in	mm	in	mm	in	mm	in				
Z8		■	■		132.9	5.23	132.8	5.23	80.0	3.15	53.3	2.10	74.9	2.94	✓	✓
Z10		1■	1■	2■	166.3	6.55	164.4	6.47	<sup>1</sup> 126.0 <sup>2</sup> 118.0	<sup>1</sup> 4.96 <sup>2</sup> 4.65	70.2	2.76	90.7	3.57	✓	✓
Z12		1■	1■	2■	198.6	7.82	196.3	7.73	<sup>1</sup> 126.0 <sup>2</sup> 118.0	<sup>1</sup> 4.96 <sup>2</sup> 4.65	86.8	3.42	106.6	4.19	✓	✓

■ Moulded uni UltraClean TwoPart Sprocket

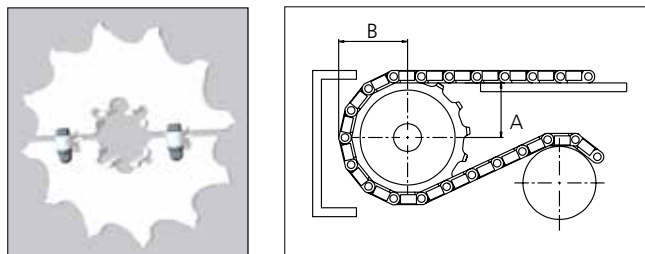

Width of UltraClean Two-part sprocket = Single row: 44.0 mm (1.73 in)  
 Width of UltraClean Two-part sprocket, tooth = Single row: 9.5 mm (0.37 in)

uni Retainer Rings: See uni Retainer Ring data sheet.  
 For correct sprocket position: See uni Assembly Instructions for uni CPB.  
 For more detailed sprocket information, contact Customer Service.

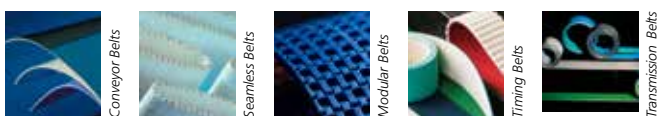

Expert advice, quality solutions and local service for all your belting needs  
[www.ammeraalbeltech.com](http://www.ammeraalbeltech.com)

**Ammeraal Beltech Modular A/S**  
 Hjulmagervej 21  
 DK-7100 Vejle

T +45 7572 3100  
 F +45 7572 3348  
 admin@unichains.com  
 www.unichains.com

This information is subject to alteration due to continuous development. Ammeraal Beltech will not be held liable for the incorrect use of the above stated information. This information replaces previous information. All activities performed and services rendered by Ammeraal Beltech are subject to general terms and conditions of sale and delivery, as applied by its operating companies.



# Plastic Modular Belt

Series **uni CPB** Type **Rough**

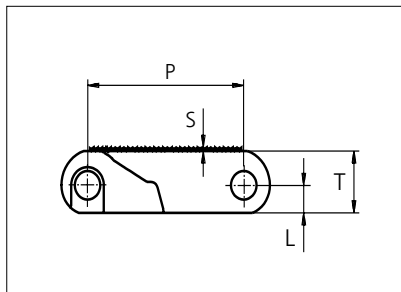
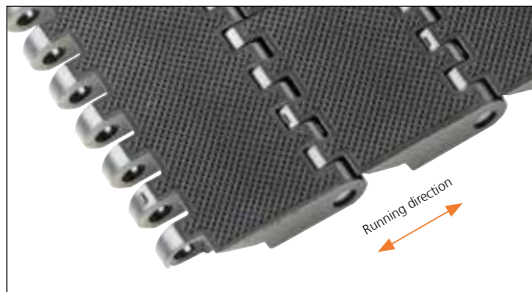

Straight running belt  
 Nominal pitch: 50.8 mm (2.00 in)  
 Surface type: Rough Top  
 Surface opening: Closed  
 Backflex radius: 85.0 mm (3.30 in)  
 Pin diameter: 8.0 mm (0.31 in)

Belt material & color	POM-NL	mm	in		mm	in	
		P (Nominal)	50.8	2.00	S	1.0	0.04
Pin material & color		L	8.0	0.31	T	18.0	0.71

Non standard material and color: See uni Material and Color Overview.  
 Alternative pin and lock systems and materials: Contact Customer Service.

Belt width		Permissible tensile force (Belt/pin material)		Belt weight (Belt/pin material)		*Min. No. drive sprocket per shaft	Number of wear strips (Min. No.)	
		POM-NL / PA6.6		POM-NL / PA6.6			**Carry (pcs)	**Return (pcs)
mm	in	N	lbf	kg/m	lb/ft			
151	5.9	7852	1765	2.5	1.68	2	2	2
202	8.0	10504	2361	3.4	2.25	2	2	2
252	9.9	13104	2946	4.2	2.81	2	2	2
302	11.9	15704	3530	5.0	3.37	3	3	2
352	13.9	18304	4115	5.8	3.93	3	3	2
403	15.9	20956	4711	6.7	4.50	3	3	2
453	17.8	23556	5295	7.5	5.05	4	4	2
503	19.8	26156	5880	8.3	5.61	4	4	2
553	21.8	28756	6464	9.2	6.17	4	4	2
604	23.8	31408	7061	10.0	6.74	5	5	3
654	25.7	34008	7645	10.9	7.30	5	5	3
704	27.7	36608	8229	11.7	7.85	5	5	3
754	29.7	39208	8814	12.5	8.41	6	6	3

Additional standard belt widths are available in steps of 50.3 mm (1.98 in). Additional non-standard belt widths are available in steps of mm 16.8 (0.66 in).

1961	77.2	101972	22923	32.6	21.88	14	14	7
------	------	--------	-------	------	-------	----	----	---

Additional standard belt widths are available in steps of 50.3 mm (1.98 in). Additional non-standard belt widths are available in steps of mm 16.8 (0.66 in).

2966	116.8	154232	34671	49.2	33.09	20	20	10
------	-------	--------	-------	------	-------	----	----	----

General belt tolerance is +0/-0.4% at 23°C/73°F and 50% RH. For exact belt width contact Customer Service. Non standard belt width on request.

\*Max. Load per Drive Sprocket. Belt material: POM-NL 2500 N (560 lbf), PP 2500 N (560 lbf).

\*\*Max. Spacing between wear strips, Carry: 152.0 mm (6.00 in); Return: 304.0 mm (12.00 in).

= Single Link



STANDARD

STRAIGHT RUNNING

PITCH 50.8 MM/2.00 IN

## Accessories

### Rubber Top

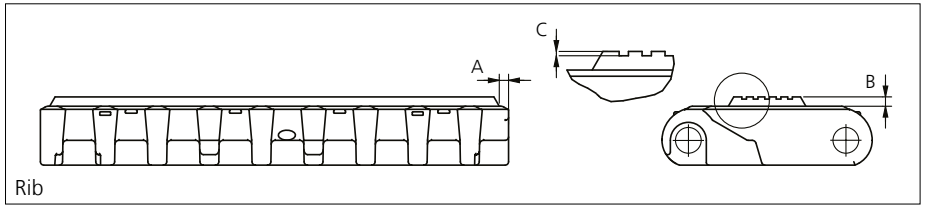
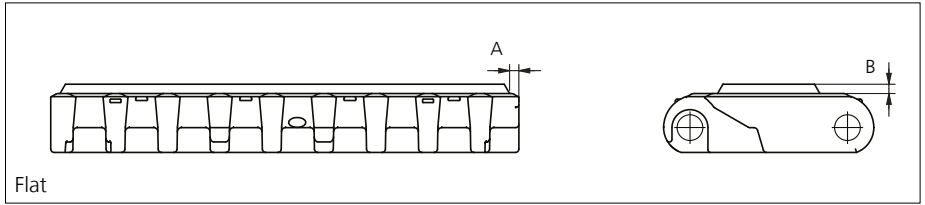

Type	Belt material & color	Rubber material & color	A		B		C		Link size	Width	
			mm	in	mm	in	mm	in		mm	in
Flat	POM-NL <b>K</b>	09 <b>K</b>	2.5	0.09	3.0	0.12	0.7	0.02	K600	150.5	5.93
Rib											

The color of standard rubber material is black. However, as it is hardly possible to see black rubber on black links, the links are illustrated with rubber in color natural. Other Non Standard Rubber profiles: See uni Rubber Profile Overview.

## Accessories

### Flight

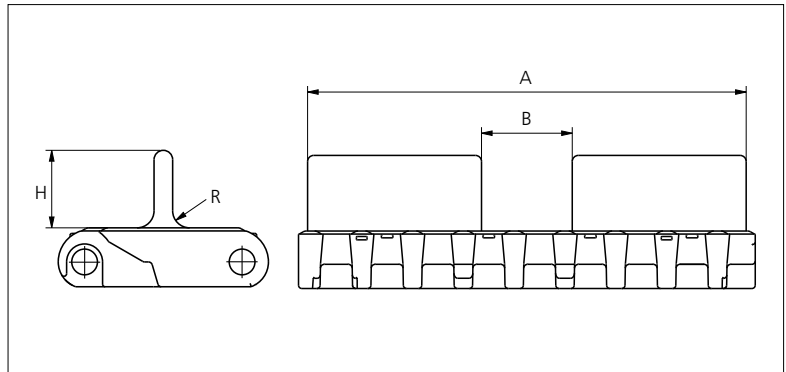
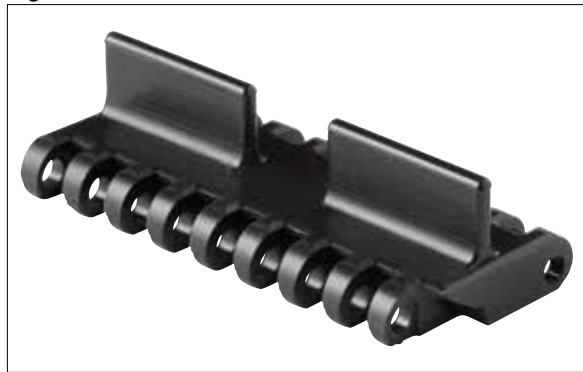

Type	Material & color	H		R		A		B		Link size	Width		Indent	
		mm	in	mm	in	mm	in	mm	in		mm	in	mm	in
Flat	POM-NL <b>K</b>	25.0	0.98	5.5	0.22	145.0	5.70	30.0	1.18	K600	150.5	5.93	2.8	0.11

Non Standard material and color: See uni Material and Color Overview.

**Accessories**

**Top/Bottom Insert NON STANDARD**



The thread inserts allow for easy attachment of fixturers to the belt.  
 Available insert size M5 + M6.  
 Depending on the size and shape of the attachment, attention should be paid as to how it will influence on the backflex radius of the belt.

**Accessories**

**Non Standard uni AmFlight**

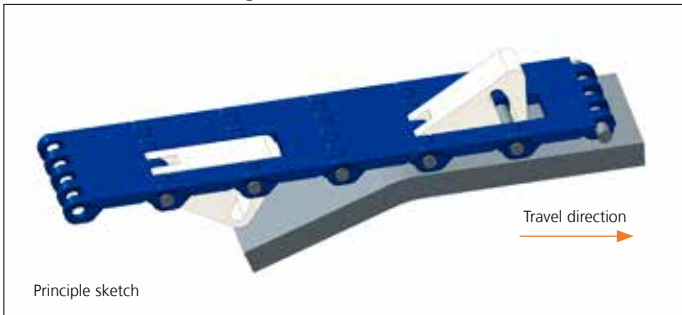

## Sprocket

No of teeth	Bore size										Overall diameter		Pitch-diameter		Hub-diameter		Dimension A		Dimension B		Single row/One way	Double row/Two way	Molded PA6 LG	Machined PA6 N
	Pilot bore		1.00		1.18		1.25		1.50															
	mm	in	25.4	30.0	31.8	38.1	40.0	60.0	63.5	90.0	mm	in	mm	in	mm	in	mm	in	mm	in				
Z06	✓	●	●	●	■	●	■				99.5	3.92	101.6	4.00	65.0	2.56	36.0	1.42	59.3	2.33	✓		✓	
Z08	✓	●	●	●	■	●	■	■			132.9	5.23	132.8	5.23	70.0	2.75	53.3	2.10	74.9	2.94	✓	1	✓	
Z10	✓		1	1	1	1	1	2	2		166.3	6.55	164.4	6.47	<sup>1</sup> 70.0 <sup>2</sup> 120.0	2.75 4.72	70.2	2.76	90.7	3.57	✓	✓	✓	
Z12	✓		1	1	1	1	1	2	2	3	198.6	7.82	196.3	7.73	<sup>1</sup> 70.0 <sup>2</sup> 120.0 <sup>3</sup> 164.0	2.75 4.72 6.45	86.8 86.8	3.42 3.42	106.6 106.6	4.19 4.19	<sup>1+2</sup> ✓	<sup>2+3</sup> ✓	✓	
Z16	✓		2 1	2 1	2	2	2	3	2	3	263.8	10.39	260.4	10.25	<sup>1</sup> 150.0 <sup>2</sup> 164.0 <sup>3</sup> 200.0	5.90 6.45 7.87	119.7	4.71	138.7	5.46	1	<sup>2+3</sup> ✓	✓	✓

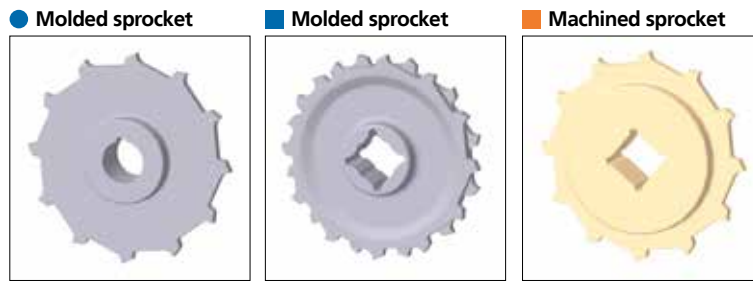

Other sprocket sizes are available upon request.  
 Other bore sizes on sprockets are available upon request.  
 Round bores are always delivered with keyway.  
 Max. load per sprocket shown does not take bore size into account.  
 Please also ensure that sufficient size shaft is chosen for corresponding load.

Width of tooth = Single row: 9.5 mm (0.37 in)  
 = Double row: 17.8 mm (0.70 in)

Width of One-part sprocket = Single row: 42.3 mm (1.66 in)  
 = Double row: 42.3 mm (1.66 in)  
 = <sup>3</sup>Double row: 50.0 mm (1.96 in)

## uni UltraClean Two-Part Sprocket

No. of teeth	Bore size				Overall diameter		Pitch-diameter		Hub-diameter		Dimension A		Dimension B		Single row/One way	Moulded PA6 W
	in	1.50	1.57	2.36												
	mm	38.1	40.0	60.0	mm	in	mm	in	mm	in	mm	in	mm	in		
Z8		■	■		132.9	5.23	132.8	5.23	80.0	3.15	53.3	2.10	74.9	2.94	✓	✓
Z10		1	1	2	166.3	6.55	164.4	6.47	<sup>1</sup> 126.0 <sup>2</sup> 118.0	<sup>1</sup> 4.96 <sup>2</sup> 4.65	70.2	2.76	90.7	3.57	✓	✓
Z12		1	1	2	198.6	7.82	196.3	7.73	<sup>1</sup> 126.0 <sup>2</sup> 118.0	<sup>1</sup> 4.96 <sup>2</sup> 4.65	86.8	3.42	106.6	4.19	✓	✓

### Moulded uni UltraClean TwoPart Sprocket

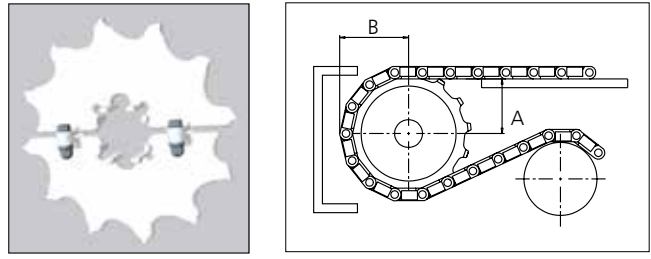

Width of UltraClean Two-part sprocket = Single row: 44.0 mm (1.73 in)  
 Width of UltraClean Two-part sprocket, tooth = Single row: 9.5 mm (0.37 in)

uni Retainer Rings: See uni Retainer Ring data sheet.  
 For correct sprocket position: See uni Assembly Instructions for uni CPB.  
 For more detailed sprocket information, contact Customer Service.



Expert advice, quality solutions and local service for all your belting needs  
[www.ammeraalbeltech.com](http://www.ammeraalbeltech.com)

**Ammeraal Beltech Modular A/S**  
 Hjulmagervej 21  
 DK-7100 Vejle

T +45 7572 3100  
 F +45 7572 3348  
 admin@unichains.com  
 www.unichains.com

This information is subject to alteration due to continuous development. Ammeraal Beltech will not be held liable for the incorrect use of the above stated information. This information replaces previous information. All activities performed and services rendered by Ammeraal Beltech are subject to general terms and conditions of sale and delivery, as applied by its operating companies.





# Plastic Modular Belt

Series **uni CPB** Type **M2 C**

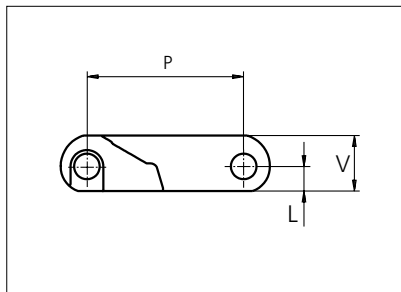

Straight running belt  
 Nominal pitch: 50.8 mm (2.00 in)  
 Surface type: Flat  
 Surface opening: Closed  
 Backflex radius: 85.0 mm (3.30 in)  
 Pin diameter: 8.0 mm (0.31 in)

Recommended Belt material & color	POM-NL <b>K</b>		mm	in		mm	in
		<b>P (Nominal)</b>	50.8	2.00	<b>V</b>	19.0	0.75
Recommended Pin material & color	PA6.6 <b>N</b>						
		<b>L</b>	8.0	0.31	-	-	-

Non standard material and color: See uni Material and Color Overview.  
 Alternative pin and lock systems and materials: Contact Customer Service.

Belt width		Permissible tensile force (Belt/pin material)				Belt weight (Belt/pin material)				*Min. No. drive sprocket per shaft	Number of wear strips (Min. No.)	
		POM-NL / PA6.6		PP/PA6.6		POM-NL / PA6.6		PP/PA6.6			**Carry (pcs)	**Return (pcs)
mm	in	N	lbf	N	lbf	kg/m	lb/ft	kg/m	lb/ft			
151	5.9	7852	1765	5285	1188	2.5	1.68	1.7	1.13	2	2	2
202	8.0	10504	2361	7070	1589	3.4	2.25	2.2	1.51	2	2	2
252	9.9	13104	2946	8820	1983	4.2	2.81	2.8	1.88	2	2	2
302	11.9	15704	3530	10570	2376	5.0	3.37	3.4	2.25	3	3	2
352	13.9	18304	4115	12320	2770	5.8	3.93	3.9	2.63	3	3	2
403	15.9	20956	4711	14105	3171	6.7	4.50	4.5	3.01	3	3	2
453	17.8	23556	5295	15855	3564	7.5	5.05	5.0	3.38	4	4	2
503	19.8	26156	5880	17605	3958	8.3	5.61	5.6	3.75	4	4	2
553	21.8	28756	6464	19355	4351	9.2	6.17	6.1	4.13	4	4	2
604	23.8	31408	7061	21140	4752	10.0	6.74	6.7	4.51	5	5	3
654	25.7	34008	7645	22890	5146	10.9	7.30	7.3	4.88	5	5	3
704	27.7	36608	8229	24640	5539	11.7	7.85	7.8	5.25	5	5	3
754	29.7	39208	8814	26390	5932	12.5	8.41	8.4	5.62	6	6	3

Additional standard belt widths are available in steps of 50.3 mm (1.98 in). Additional non-standard belt widths are available in steps of mm 16.8 (0.66 in).

1961	77.2	101972	22923	68635	15429	32.6	21.88	21.8	14.63	14	14	7
------	------	--------	-------	-------	-------	------	-------	------	-------	----	----	---

Additional standard belt widths are available in steps of 50.3 mm (1.98 in). Additional non-standard belt widths are available in steps of mm 16.8 (0.66 in).

2966	116.8	154232	34671	103810	23336	49.2	33.09	32.9	22.13	20	20	10
------	-------	--------	-------	--------	-------	------	-------	------	-------	----	----	----

General belt tolerance is +0/-0.4% at 23°C/73°F and 50% RH. For exact belt width contact Customer Service. Non standard belt width on request.

\*Max. Load per Drive Sprocket. Belt material: POM-NL 2500 N (560 lbf). PP 2500 N (560 lbf)

\*\*Max. Spacing between wear strips. Carry: 152 mm (6 in); Return: 304 mm (12 in)

= Single Link



NON STANDARD

STRAIGHT RUNNING

PITCH 50.8 MM/2.00 IN

## Accessories

### Rubber Top

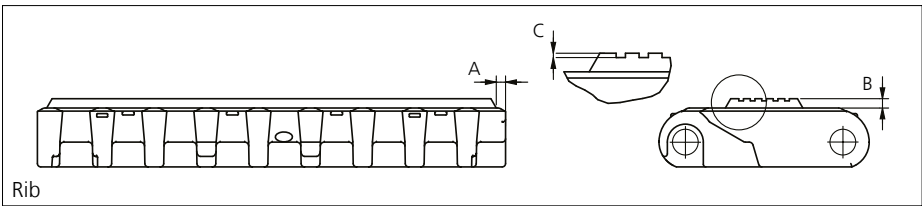
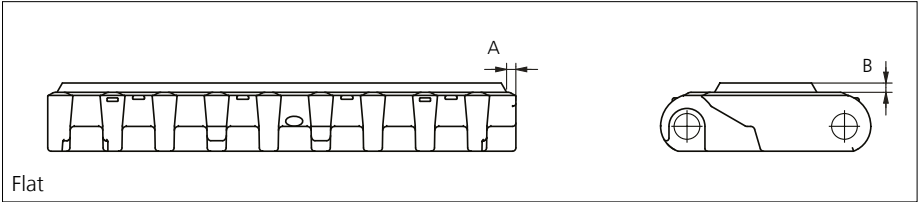

Type	Belt material & color	Rubber material & color	A		B		C		Link size	Width	
			mm	in	mm	in	mm	in		mm	in
Flat	POM-NL <b>K</b>	09 <b>K</b>	2.5	0.09	3.0	0.12	0.7	0.02	K600	150.5	5.93
Rib											

The color of standard rubber material is black. However, as it is hardly possible to see black rubber on black links, the links are illustrated with rubber in color natural.  
 Other Non Standard Rubber profiles: See uni Rubber Profile Overview.

### Sprocket

No of teeth	Pilot bore	Bore size									Overall diameter		Pitch-diameter		Hub-diameter		Dimension A		Dimension B		Single row/One way	Double row/Two way	Molded PA6 LG	Machined PA6 N
		in	1.00	1.18	1.25	1.50	1.57	2.36	2.50	3.54														
		mm	25.4	30.0	31.8	38.1	40.0	60.0	63.5	90.0	mm	in	mm	in	mm	in	mm	in	mm	in				
Z06	✓	●	●	●	■	●	■				99.5	3.92	101.6	4.00	65.0	2.56	36.0	1.42	59.3	2.33	✓		✓	
Z08	✓	●	●	●	■	●	■	■			132.9	5.23	132.8	5.23	70.0	2.75	53.3	2.10	74.9	2.94	✓	1✓	✓	
Z10	✓		1●	1●	1●	1●	1■	2■	2■		166.3	6.55	164.4	6.47	<sup>1</sup> 70.0 <sup>2</sup> 120.0	2.75 4.72	70.2	2.76	90.7	3.57	✓	✓	✓	
Z12	✓		1●	1●	1●	1●	1■	2■	2■	3■	198.6	7.82	196.3	7.73	<sup>1</sup> 70.0 <sup>2</sup> 120.0 <sup>3</sup> 164.0	2.75 4.72 6.45	86.8 86.8	3.42 3.42	106.6 106.6	4.19 4.19	1+2✓	2+3✓	✓	
Z16	✓		2● 1●	2● 1●	2● 1●	2● 1●	2● 1●	3● 1●	2● 1●	3●	263.8	10.39	260.4	10.25	<sup>1</sup> 150.0 <sup>2</sup> 164.0 <sup>3</sup> 200.0	5.90 6.45 7.87	119.7	4.71	138.7	5.46	1✓	2+3✓	✓	✓

● Molded sprocket    ■ Molded sprocket    ■ Machined sprocket



Other sprocket sizes are available upon request.  
 Other bore sizes on sprockets are available upon request.  
 Round bores are always delivered with keyway.  
 Max. load per sprocket shown does not take bore size into account.  
 Please also ensure that sufficient size shaft is chosen for corresponding load.  
 Width of tooth = Single row: 9.5 mm (0.37 in)  
 = Double row: 17.8 mm (0.70 in)  
 Width of One-part sprocket = Single row: 42.3 mm (1.66 in)  
 = Double row: 42.3 mm (1.66 in)  
 = <sup>3</sup>Double row: 50.0 mm (1.96 in)

### uni UltraClean Two-Part Sprocket

No. of teeth	Bore size				Overall diameter		Pitch-diameter		Hub-diameter		Dimension A		Dimension B		Single row/One way	Moulded PA6 W
	in	1.50	1.57	2.36												
	mm	38.1	40.0	60.0	mm	in	mm	in	mm	in	mm	in	mm	in		
Z8		■	■		132.9	5.23	132.8	5.23	80.0	3.15	53.3	2.10	74.9	2.94	✓	✓
Z10		1■	1■	2■	166.3	6.55	164.4	6.47	<sup>1</sup> 126.0 <sup>2</sup> 118.0	<sup>1</sup> 4.96 <sup>2</sup> 4.65	70.2	2.76	90.7	3.57	✓	✓
Z12		1■	1■	2■	198.6	7.82	196.3	7.73	<sup>1</sup> 126.0 <sup>2</sup> 118.0	<sup>1</sup> 4.96 <sup>2</sup> 4.65	86.8	3.42	106.6	4.19	✓	✓

■ Moulded uni UltraClean TwoPart Sprocket

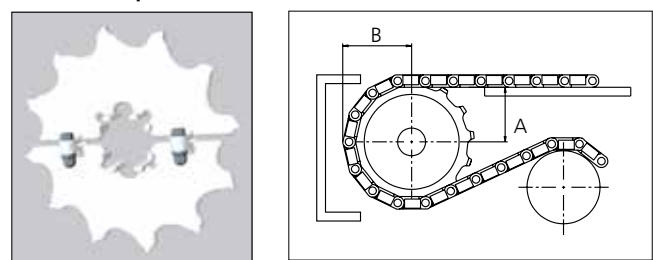

Width of UltraClean Two-part sprocket = Single row: 44.0 mm (1.73 in)  
 Width of UltraClean Two-part sprocket, tooth = Single row: 9.5 mm (0.37 in)

uni Retainer Rings: See uni Retainer Ring data sheet.  
 For correct sprocket position: See uni Assembly Instructions for uni CPB.  
 For more detailed sprocket information, contact Customer Service.



Conveyor Belts



Seamless Belts

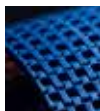

Modular Belts



Timing Belts

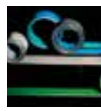

Transmission Belts



Fabrication & service

Expert advice, quality solutions and local service for all your belting needs  
[www.ammeraalbeltech.com](http://www.ammeraalbeltech.com)

**Ammeraal Beltech Modular A/S**  
Hjulmagervej 21  
DK-7100 Vejle

T +45 7572 3100  
F +45 7572 3348  
admin@unichains.com  
www.unichains.com

This information is subject to alteration due to continuous development. Ammeraal Beltech will not be held liable for the incorrect use of the above stated information. This information replaces previous information. All activities performed and services rendered by Ammeraal Beltech are subject to general terms and conditions of sale and delivery, as applied by its operating companies.



# Plastic Modular Belt

Series **uni CPB** Type **M2 Rough**

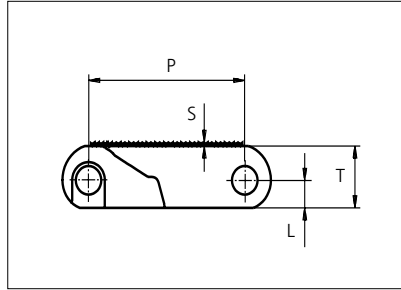

Straight running belt  
 Nominal pitch: 50.8 mm (2.00 in)  
 Surface type: Rough Top  
 Surface opening: Closed  
 Backflex radius: 85.0 mm (3.30 in)  
 Pin diameter: 8.0 mm (0.31 in)

Recommended Belt material & color	POM-NL <b>K</b>		mm	in		mm	in
		<b>P (Nominal)</b>	50.8	2.00	<b>S</b>	1.0	0.04
Recommended Pin material & color	PA6.6 <b>N</b>						
		<b>L</b>	8.0	0.31	<b>T</b>	19.0	0.71

Non standard material and color: See uni Material and Color Overview.  
 Alternative pin and lock systems and materials: Contact Customer Service.

Belt width		Permissible tensile force (Belt/pin material)				Belt weight (Belt/pin material)				*Min. No. drive sprocket per shaft	Number of wear strips (Min. No.)	
		POM-NL / PA6.6		PP/PA6.6		POM-NL / PA6.6		PP/PA6.6			**Carry (pcs)	**Return (pcs)
mm	in	N	lbf	N	lbf	kg/m	lb/ft	kg/m	lb/ft			
151	5.9	7852	1765	5285	1188	2.5	1.68	1.7	1.13	2	2	2
202	8.0	10504	2361	7070	1589	3.4	2.25	2.2	1.51	2	2	2
252	9.9	13104	2946	8820	1983	4.2	2.81	2.8	1.88	2	2	2
302	11.9	15704	3530	10570	2376	5.0	3.37	3.4	2.25	3	3	2
352	13.9	18304	4115	12320	2770	5.8	3.93	3.9	2.63	3	3	2
403	15.9	20956	4711	14105	3171	6.7	4.50	4.5	3.01	3	3	2
453	17.8	23556	5295	15855	3564	7.5	5.05	5.0	3.38	4	4	2
503	19.8	26156	5880	17605	3958	8.3	5.61	5.6	3.75	4	4	2
553	21.8	28756	6464	19355	4351	9.2	6.17	6.1	4.13	4	4	2
604	23.8	31408	7061	21140	4752	10.0	6.74	6.7	4.51	5	5	3
654	25.7	34008	7645	22890	5146	10.9	7.30	7.3	4.88	5	5	3
704	27.7	36608	8229	24640	5539	11.7	7.85	7.8	5.25	5	5	3
754	29.7	39208	8814	26390	5932	12.5	8.41	8.4	5.62	6	6	3

Additional standard belt widths are available in steps of 50.3 mm (1.98 in). Additional non-standard belt widths are available in steps of mm 16.8 (0.66 in).

1961	77.2	101972	22923	68635	15429	32.6	21.88	21.8	14.63	14	14	7
------	------	--------	-------	-------	-------	------	-------	------	-------	----	----	---

Additional standard belt widths are available in steps of 50.3 mm (1.98 in). Additional non-standard belt widths are available in steps of mm 16.8 (0.66 in).

2966	116.8	154232	34671	103810	23336	49.2	33.09	32.9	22.13	20	20	10
------	-------	--------	-------	--------	-------	------	-------	------	-------	----	----	----

General belt tolerance is +0/-0.4% at 23°C/73°F and 50% RH. For exact belt width contact Customer Service. Non standard belt width on request.

\*Max. Load per Drive Sprocket. Belt material: POM-NL 2500 N (560 lbf). PP 2500 N (560 lbf).

\*\*Max. Spacing between wear strips. Carry: 152 mm (6 in); Return: 304 mm (12 in).

= Single Link



NON STANDARD

STRAIGHT RUNNING

PITCH 50.8 MM/2.00 IN

## Accessories

### Rubber Top

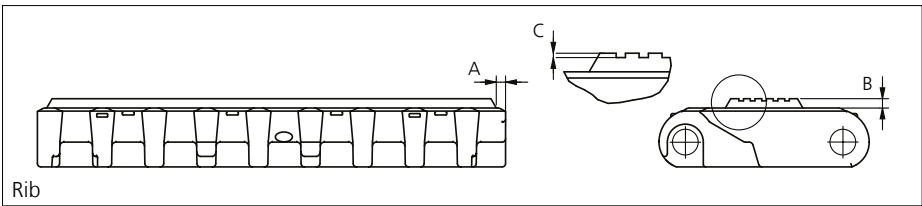
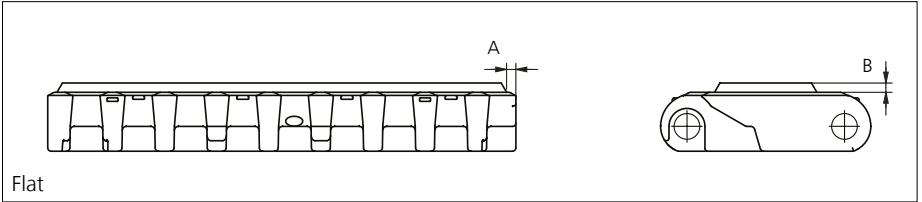

Type	Belt material & color	Rubber material & color	A		B		C		Link size	Width	
			mm	in	mm	in	mm	in		mm	in
Flat	POM-NL <b>K</b>	09 <b>K</b>	2.5	0.09	3.0	0.12	0.7	0.02	K600	150.5	5.93
Rib											

The color of standard rubber material is black. However, as it is hardly possible to see black rubber on black links, the links are illustrated with rubber in color natural. Other Non Standard Rubber profiles: See uni Rubber Profile Overview.

### Sprocket

No of teeth	Pilot bore	Bore size									Overall diameter		Pitch-diameter		Hub-diameter		Dimension A		Dimension B		Single row/One way	Double row/Two way	Molded PA6 LG	Machined PA6 N
		in	1.00	1.18	1.25	1.50	1.57	2.36	2.50	3.54														
		mm	25.4	30.0	31.8	38.1	40.0	60.0	63.5	90.0	mm	in	mm	in	mm	in	mm	in	mm	in				
Z06	✓	●	●	●	■	●	■				99.5	3.92	101.6	4.00	65.0	2.56	36.0	1.42	59.3	2.33	✓		✓	
Z08	✓	●	●	●	■	●	■	■			132.9	5.23	132.8	5.23	70.0	2.75	53.3	2.10	74.9	2.94	✓	<sup>1</sup> ✓	✓	
Z10	✓		<sup>1</sup> ●	<sup>1</sup> ●	<sup>1</sup> ●	<sup>1</sup> ●	<sup>2</sup> ■	<sup>2</sup> ■			166.3	6.55	164.4	6.47	<sup>1</sup> 70.0 <sup>2</sup> 120.0	2.75 4.72	70.2	2.76	90.7	3.57	✓	✓	✓	
Z12	✓		<sup>1</sup> ●	<sup>1</sup> ●	<sup>1</sup> ●	<sup>1</sup> ●	<sup>2</sup> ■	<sup>2</sup> ■	<sup>3</sup> ■		198.6	7.82	196.3	7.73	<sup>1</sup> 70.0 <sup>2</sup> 120.0 <sup>3</sup> 164.0	2.75 4.72 6.45	86.8 86.8	3.42 3.42	106.6 106.6	4.19 4.19	<sup>1+2</sup> ✓	<sup>2+3</sup> ✓	✓	
Z16	✓		<sup>2</sup> ● <sup>1</sup> ●	<sup>2</sup> ● <sup>1</sup> ●	<sup>2</sup> ● <sup>1</sup> ●	<sup>2</sup> ● <sup>1</sup> ●	<sup>2</sup> ■ <sup>1</sup> ■	<sup>3</sup> ■ <sup>1</sup> ■	<sup>2</sup> ■ <sup>1</sup> ■	<sup>3</sup> ■	263.8	10.39	260.4	10.25	<sup>1</sup> 150.0 <sup>2</sup> 164.0 <sup>3</sup> 200.0	5.90 6.45 7.87	119.7	4.71	138.7	5.46	<sup>1</sup> ✓	<sup>2+3</sup> ✓	✓	✓

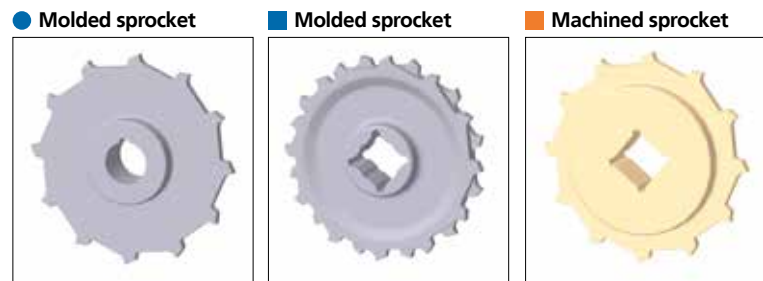

Other sprocket sizes are available upon request.  
 Other bore sizes on sprockets are available upon request.  
 Round bores are always delivered with keyway.  
 Max. load per sprocket shown does not take bore size into account.  
 Please also ensure that sufficient size shaft is chosen for corresponding load.

Width of tooth = Single row: 9.5 mm (0.37 in)  
 = Double row: 17.8 mm (0.70 in)

Width of One-part sprocket = Single row: 42.3 mm (1.66 in)  
 = Double row: 42.3 mm (1.66 in)  
 = <sup>3</sup>Double row: 50.0 mm (1.96 in)

### uni UltraClean Two-Part Sprocket

No. of teeth	Bore size				Overall diameter		Pitch-diameter		Hub-diameter		Dimension A		Dimension B		Single row/One way	Moulded PA6 W
	in	1.50	1.57	2.36												
	mm	38.1	40.0	60.0	mm	in	mm	in	mm	in	mm	in				
Z8		■	■		132.9	5.23	132.8	5.23	80.0	3.15	53.3	2.10	74.9	2.94	✓	✓
Z10		<sup>1</sup> ■	<sup>1</sup> ■	<sup>2</sup> ■	166.3	6.55	164.4	6.47	<sup>1</sup> 126.0 <sup>2</sup> 118.0	<sup>1</sup> 4.96 <sup>2</sup> 4.65	70.2	2.76	90.7	3.57	✓	✓
Z12		<sup>1</sup> ■	<sup>1</sup> ■	<sup>2</sup> ■	198.6	7.82	196.3	7.73	<sup>1</sup> 126.0 <sup>2</sup> 118.0	<sup>1</sup> 4.96 <sup>2</sup> 4.65	86.8	3.42	106.6	4.19	✓	✓

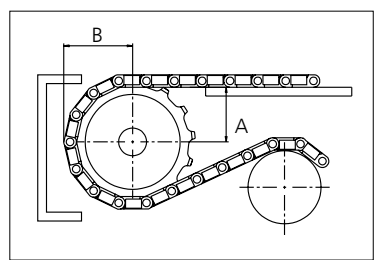

Width of UltraClean Two-part sprocket = Single row: 44.0 mm (1.73 in)  
 Width of UltraClean Two-part sprocket, tooth = Single row: 9.5 mm (0.37 in)

uni Retainer Rings: See uni Retainer Ring data sheet.  
 For correct sprocket position: See uni Assembly Instructions for uni CP8.  
 For more detailed sprocket information, contact Customer Service.



Conveyor Belts



Seamless Belts



Modular Belts



Timing Belts

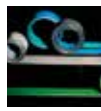

Transmission Belts



Fabrication & service

Expert advice, quality solutions and local service for all your belting needs [www.ammeraalbeltech.com](http://www.ammeraalbeltech.com)

**Ammeraal Beltech Modular A/S**  
Hjulmagervej 21  
DK-7100 Vejle

T +45 7572 3100  
F +45 7572 3348  
admin@unichains.com  
www.unichains.com

This information is subject to alteration due to continuous development. Ammeraal Beltech will not be held liable for the incorrect use of the above stated information. This information replaces previous information. All activities performed and services rendered by Ammeraal Beltech are subject to general terms and conditions of sale and delivery, as applied by its operating companies.





# Plastic Modular Belt

Series **uni CSB** Type **8% Rough**

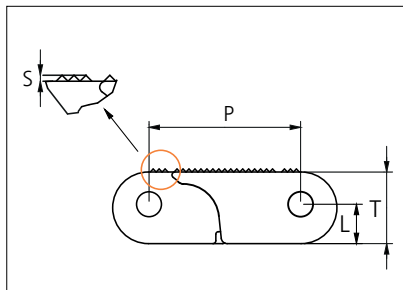

Straight running belt  
 Nominal pitch: 50.8 mm (2.00 in)  
 Surface type: Rough (R11)  
 Surface opening: 8%  
 Backflex radius: 100 mm (3.94 in)  
 Pin diameter: 8.0 mm (0.31 in)

<b>Belt material &amp; color</b>	POM NL <b>K</b>	POX-FR <b>EG</b>		<b>mm</b>	<b>in</b>		<b>mm</b>	<b>in</b>
<b>Pin and lock material &amp; color</b>	PA6.6 <b>N</b> PP <b>O</b>	PBT <b>LG</b> PP <b>O</b>	<b>P (Nominal)</b>	50.8	2.00	<b>T</b>	24.0	0.94
			<b>L</b>	13.2	0.52	<b>S</b>	1.0	0.04

Non standard material and color: See uni Material and Color Overview.  
 Safety edges with orange or yellow edge links mounted on alternating pitches along both belt edges are optional.  
 Alternative pin and lock systems and materials: Contact Customer Service.

Belt width		Permissible tensile force (Belt/pin material)				***Belt weight (Belt/pin material)		Min No drive sprocket per shaft	Number of wear strips (min no)	
		POM NL/PA66 POX-FR/PBT		POM NL/SS POX-FR/SS		POM NL/PA66			**Carry (pcs)	**Return (pcs)
mm	in	N	lbf	N	lbf	Kg/m	lb/ft			
153	6.0	13725	3085	15250	3428	2.9	1.92	2	2	2
305	12.0	27450	6171	30500	6856	5.7	3.83	3	3	2
458	18.0	41177	9257	45753	10285	8.6	5.75	4	4	2
610	24.0	54905	12343	61005	13714	11.4	7.67	5	5	3
763	30.0	68632	15429	76258	17143	14.3	9.58	6	6	3
915	36.0	82360	18514	91511	20572	17.1	11.50	7	7	4
1068	42.0	96087	21600	106764	24000	20.0	13.42	8	8	4
1220	48.0	109815	24686	122016	27429	22.8	15.33	9	9	5
1373	54.0	123542	27772	137269	30858	25.7	17.25	10	10	5
1525	60.0	137269	30858	152522	34287	28.5	19.17	11	11	6
1678	66.1	150997	33944	167774	37716	31.4	21.08	12	12	6
1830	72.1	164724	37030	183027	41144	34.2	23.00	13	13	7

Additional standard belt widths are available in steps of 152.5 mm (6.00 in). Additional non-standard belt widths are available in steps of 25.4 mm (1.00 in).

2898	114.1	260820	58632	289800	65147	54.2	36.42	20	20	10
------	-------	--------	-------	--------	-------	------	-------	----	----	----

Additional standard belt widths are available in steps of 152.5 mm (6.00 in). Additional non-standard belt widths are available in steps of 25.4 mm (1.00 in).

3965	156.1	356850	80220	396500	89133	74.1	49.83	27	27	14
------	-------	--------	-------	--------	-------	------	-------	----	----	----

General belt tolerance is +0/-0.4% at 23°C/73°F and 50% RH. For exact belt width contact Customer Service. Non standard belt width on request.

The belt width in POX FR is 1.0 % wider than the belt width in the table

\*Max. Load per Drive Sprocket. Belt material: NL 6000 N (1349 lbf). PP 4000 N (899 lbf). POX FR 6000 N (1349 lbf)

\*\*Max. Spacing between wear strips. Carry: 152.0 mm (6.00 in); Return: 304.0 mm (12.00 in)

\*\*\*The weight of the belt with SS pins is 6.7 kg/m<sup>2</sup> (0.42 lb/ft<sup>2</sup>) higher than with PA66 pins

\*\*\*\*The weight in POX FR is approximately 12 % lower than the weight of NL

□ = Single Link



STANDARD

STRAIGHT RUNNING

PITCH 50.8 MM/2.00 IN

## Accessories

### NON STANDARD – Rubber Top

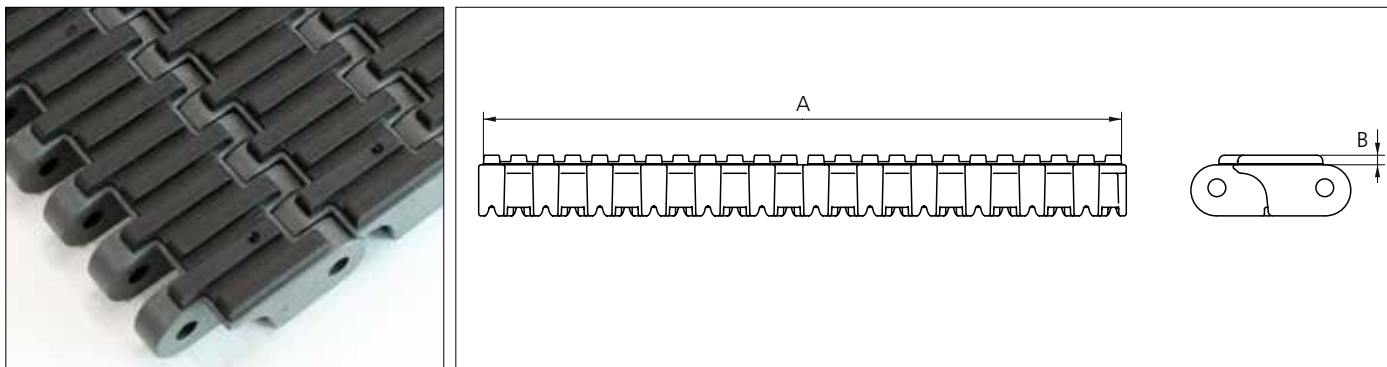

Type	Recommended belt material & color	Recommended rubber material & color	A		B		Link size	Width	
			mm	in	mm	in		mm	in
Flat Rib	PP <b>DG</b>	03 <b>K</b>	300.0	11.81	4.5	0.18	K1200	304.8	12.00

Backflex radius when flights are used: 200 mm (7.87 in).

## Accessories

### Top/Bottom Insert

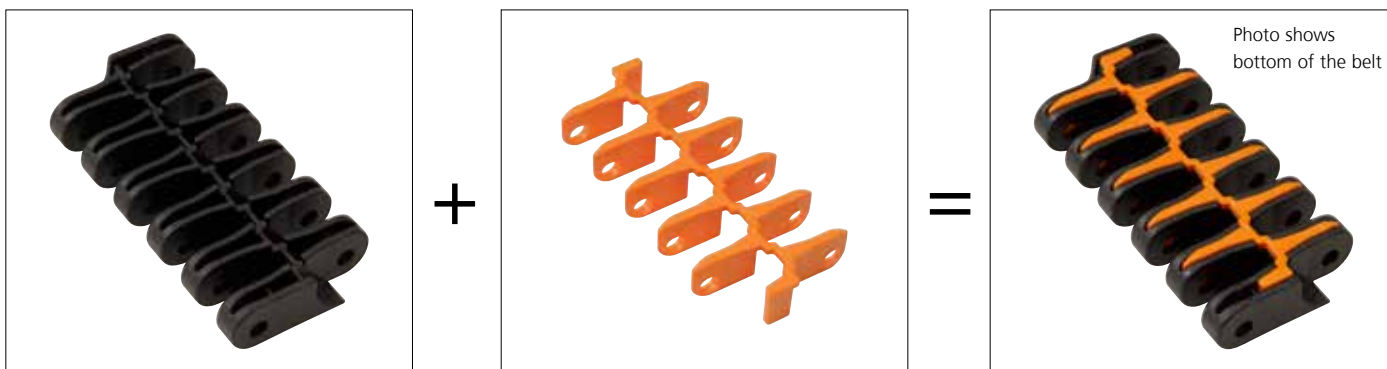

Type	Insert material & color	Weight	
		kg/m <sup>2</sup>	lb/ft <sup>2</sup>
Wheel Plate	POM DK <b>O</b>	4.7	0.97

Contact area/wear surface of belt will increase from 24% to 47% by the use of inserts.

## Accessories

### Top/Bottom Insert

EC insert in uni CSB 8% Rough type can be built in to uni CSB C to create an electrical conductive belt.



Type	Insert material & color	Weight	
		kg/m <sup>2</sup>	lb/ft <sup>2</sup>
Electrical Conductive	POX-FREC <b>K</b>	5.3	1.09

Contact area/wear surface of belt will increase from 24% to 47% by the use of inserts.  
POX-FREC holds a surface resistivity of 1x10<sup>3</sup> Ohm according to IEC 60093/ASTM D257.

## Accessories

### Flight

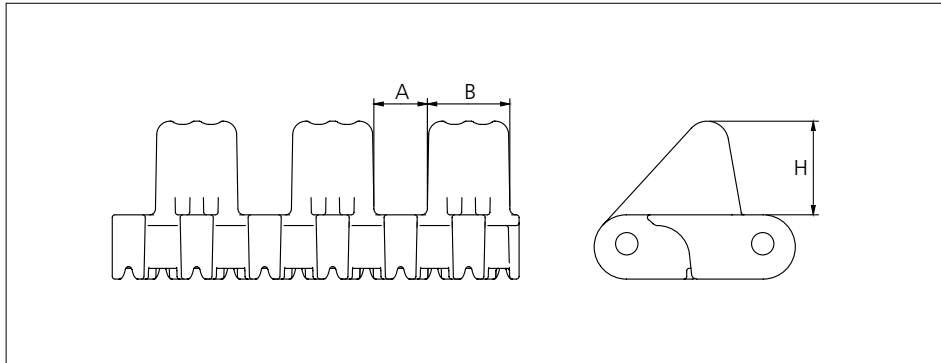

Type	Flight material & color	A		B		H		Link size	Width	
		mm	in	mm	in	mm	in		mm	in
Car Pusher	POM NL <span style="background-color: orange;">O</span>	20.0	0.79	31.0	1.22	35.0	1.38	K600	152.4	6.00

Backflex radius when flights are used: 200 mm (7.87 in).

## Accessories

### Flight

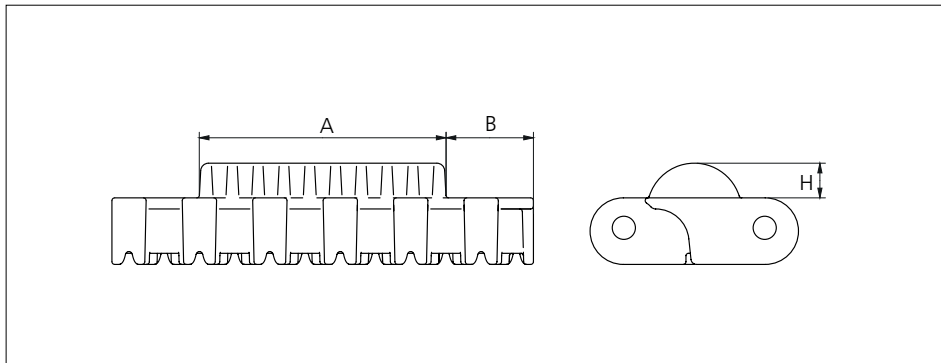

Type	Flight material & color	A		B		H		Link size	Width	
		mm	in	mm	in	mm	in		mm	in
Curved Flight	POM NL <span style="background-color: yellow;">Y</span>	89.0	3.50	31.5	1.24	12.5	0.49	K600	152.4	6.00

## Accessories

### Side Guard

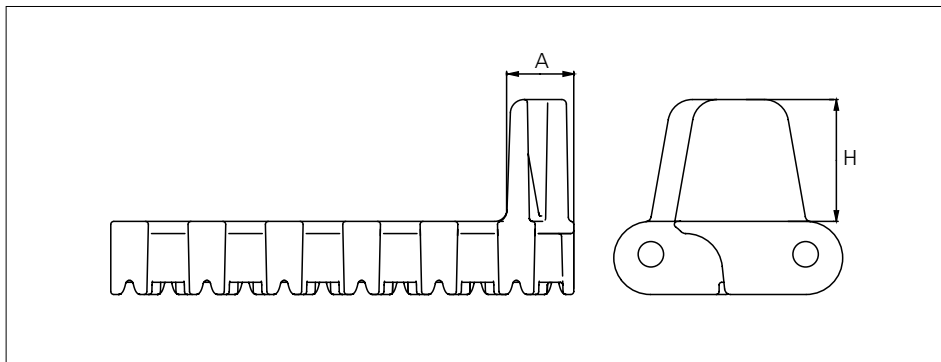

Type	Flight material & color	A		H		Link size	Width	
		mm	in	mm	in		mm	in
Side Guard	POM NL <span style="background-color: orange;">O</span>	23.0	0.91	40.0	1.57	K600	152.4	6.00

Backflex radius when side guards are used: 115 mm (4.53 in).

## Sprocket

No of teeth	Bore size					Overall diameter		Pitch-diameter		Hub-diameter		Dimension A		Dimension B		Double row/Two way	Molded	Machined
	Pilot bore	in	2.36	3.54	3.54													
	mm	60.0	90.0	120.0	mm	in	mm	in	mm	in	mm	in						
Z12	✓		■	■		197.3	7.77	197.0	7.76	150.0	5.91	82.0	3.23	109.4	4.31	✓	✓	
Z16	✓		■	■	■	263	10.35	261.4	10.29	200.0	7.87	115.0	4.53	141.5	5.57	✓	✓	✓

\*A-dimension for automotive applications use A = (B-23.0 mm/0.91 in).

Non standard material and color: See uni Material and Color Overview.

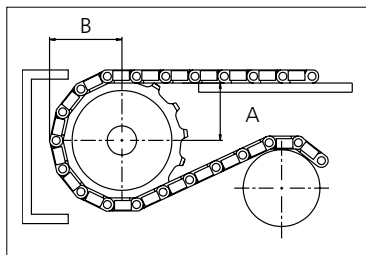
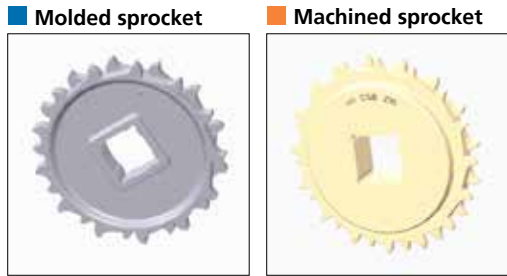

Other sprocket sizes are available upon request.  
 Two-part sprockets are available upon request.  
 Other bore sizes are available upon request.  
 uni Retainer Rings: See uni Retainer Ring data sheet  
 Width of single tooth = 10.0 mm (0.39 in)  
 Width of sprocket = 50.0 mm (1.98 in)

Max load per sprocket shown does not take bore size into account.  
 Please also ensure that sufficient size shaft is chosen for corresponding load.

For correct sprocket position: See uni Assembly Instructions for uni CSB.  
 For more detailed sprocket information, contact Customer Service.

uni CSB 8% Rough/2019.06.06



Expert advice, quality solutions and local service for all your belting needs  
[www.ammeraalbeltech.com](http://www.ammeraalbeltech.com)

**Ammeraal Beltech Modular A/S**  
 Hjulmagervej 21  
 DK-7100 Vejle

T +45 7572 3100  
 F +45 7572 3348  
 admin@unichains.com  
 www.unichains.com

This information is subject to alteration due to continuous development. Ammeraal Beltech will not be held liable for the incorrect use of the above stated information. This information replaces previous information. All activities performed and services rendered by Ammeraal Beltech are subject to general terms and conditions of sale and delivery, as applied by its operating companies.



# Plastic Modular Belt

Series **uni CSB** Type **C**

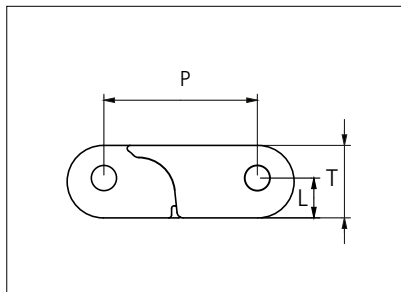

Straight running belt  
 Nominal pitch: 50.8 mm (2.00 in)  
 Surface type: Flat  
 Surface opening: Closed  
 Backflex radius: 100 mm (3.94 in)  
 Pin diameter: 8.0 mm (0.31 in)

STANDARD

<b>Belt material &amp; color</b>	POM NL <b>K</b>		<b>mm</b>	<b>in</b>		<b>mm</b>	<b>in</b>
<b>Pin and lock material &amp; color</b>	PA6.6 <b>N</b> PP <b>O</b>	<b>P (Nominal)</b>	50.8	2.00	<b>T</b>	24.0	0.94
		<b>L</b>	13.2	0.52	-	-	-

Non standard material and color: See uni Material and Color Overview.  
 Safety edges with orange or yellow edge links mounted on alternating pitches along both belt edges are optional.  
 Alternative pin and lock systems and materials: Contact Customer Service.

STRAIGHT RUNNING

Belt width		Permissible tensile force (Belt/pin material)				Belt weight (Belt/pin material)				**Min No drive sprocket per shaft	Number of wear strips (min no)	
		POM NL/PA66		POM NL/SS		POM NL/PA66		POM NL/SS			***Carry (pcs)	***Return (pcs)
mm	in	N	lbf	N	lbf	Kg/m	lb/ft	Kg/m	lb/ft			
102	4.0	9180	2064	10200	2293	1.9	1.28	2.6	1.74	2	2	2
153	6.0	13770	3095	15300	3439	2.9	1.92	3.9	2.61	2	2	2
305	12.0	27450	6171	30500	6856	5.7	3.83	7.7	5.21	3	3	2
458	18.0	41220	9266	45800	10296	8.6	5.76	11.6	7.82	4	4	2
610	24.0	54900	12342	61000	13713	11.4	7.67	15.5	10.41	5	5	3
763	30.0	68670	15437	76300	17152	14.3	9.59	19.4	13.02	6	6	3
915	36.0	82350	18512	91500	20569	17.1	11.50	23.2	15.62	7	7	4
1068	42.0	96120	21608	106800	24009	20.0	13.42	27.1	18.23	8	8	4
1220	48.0	109800	24683	122000	27426	22.8	15.33	31.0	20.83	9	9	5
1373	54.1	123570	27779	137300	30865	25.7	17.25	34.9	23.44	10	10	5
1525	60.0	137250	30854	152500	34282	28.5	19.17	38.7	26.03	11	11	6
1678	66.1	151020	33949	167800	37721	31.4	21.09	42.6	28.64	12	12	6

Additional standard belt widths are available in steps of 152.5 mm (6.00 in). Additional non-standard belt widths are available in steps of 25.4 mm (1.00 in).

2898	114.1	260820	58632	289800	65147	54.2	36.42	73.6	49.47	20	20	10
------	-------	--------	-------	--------	-------	------	-------	------	-------	----	----	----

Additional standard belt widths are available in steps of 152.5 mm (6.00 in). Additional non-standard belt widths are available in steps of 25.4 mm (1.00 in).

4880	192.1	439200	98732	488000	109702	91.3	61.33	124.0	83.30	33	33	17
------	-------	--------	-------	--------	--------	------	-------	-------	-------	----	----	----

General belt tolerance is +0/-0.4% at 23°C/73°F and 50% RH. For exact belt width contact Customer Service. Non standard belt width on request.

\*\*Max. Load per Drive Sprocket. Belt material: NL 6000 N (1349 lbf), PP 4000 N (899 lbf)

\*\*\*Max. Spacing between wear strips, Carry: 152.0 mm (6.00 in); Return: 304.0 mm (12.00 in).

= Single Link

PITCH 50.8 MM/2.00 IN



## Accessories

### NON STANDARD – Rubber Top

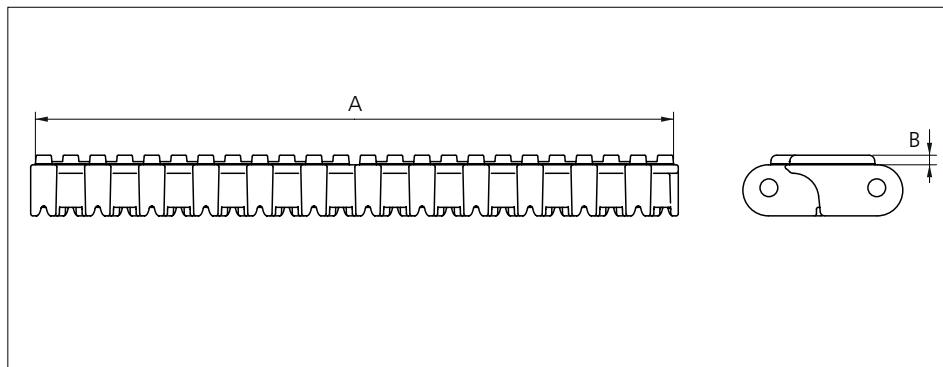

Type	Recommended belt material & color	Recommended rubber material & color	A		B		Link size	Width	
			mm	in	mm	in		mm	in
Flat Rib	PP <b>DG</b>	03 <b>K</b>	300.0	11.81	4.5	0.18	K1200	304.8	12.00

Backflex radius when flights are used: 200 mm (7.87 in).

## Accessories

### Top/Bottom Insert



+

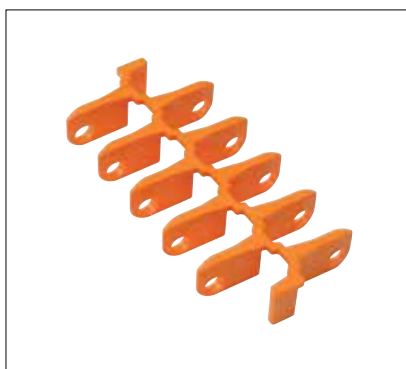

=



Type	Insert material & color	Weight	
		kg/m <sup>2</sup>	lb/ft <sup>2</sup>
Wheel Plate	POM DK <b>O</b>	4.7	0.97

Contact area/wear surface of belt will increase from 24% to 47% by the use of inserts.

## Accessories

### Top/Bottom Insert

EC insert in uni CSB 8% Rough type can be build in to uni CSB C to create an electrical conductive belt.



+



=



Type	Insert material & color	Weight	
		kg/m <sup>2</sup>	lb/ft <sup>2</sup>
Electrical Conductive	POX-FREC <b>K</b>	5.3	1.09

Contact area/wear surface of belt will increase from 24% to 47% by the use of inserts.  
POX-FREC holds a surface resistivity of 1x10<sup>3</sup> Ohm according to IEC 60093/ASTM D257.

## Accessories

### Flight

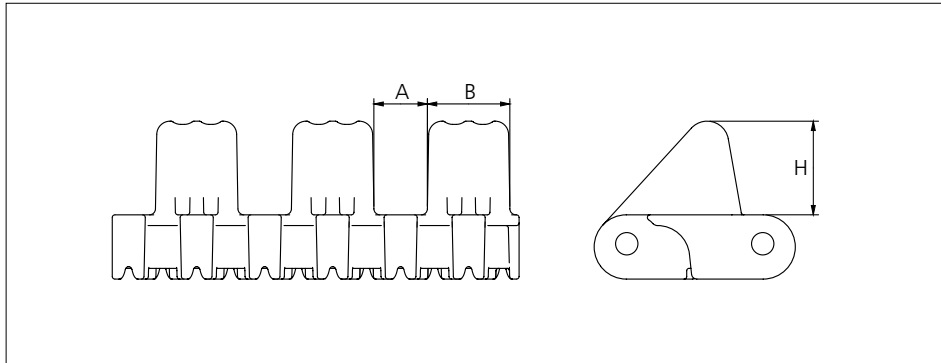

Type	Flight material & color	A		B		H		Link size	Width	
		mm	in	mm	in	mm	in		mm	in
Car Pusher	POM NL <span style="background-color: orange;">O</span>	20.0	0.79	31.0	1.22	35.0	1.38	K600	152.4	6.00

Backflex radius when flights are used: 200 mm (7.87 in).

## Accessories

### Flight

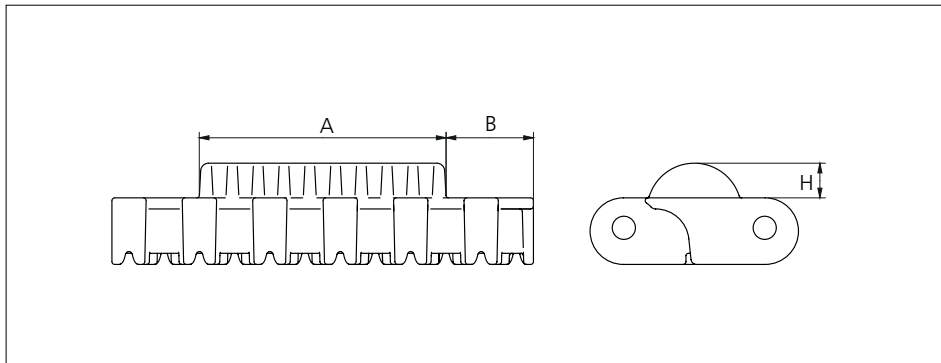

Type	Flight material & color	A		B		H		Link size	Width	
		mm	in	mm	in	mm	in		mm	in
Curved Flight	POM NL <span style="background-color: yellow;">Y</span>	89.0	3.50	31.5	1.24	12.5	0.49	K600	152.4	6.00

## Accessories

### Side Guard

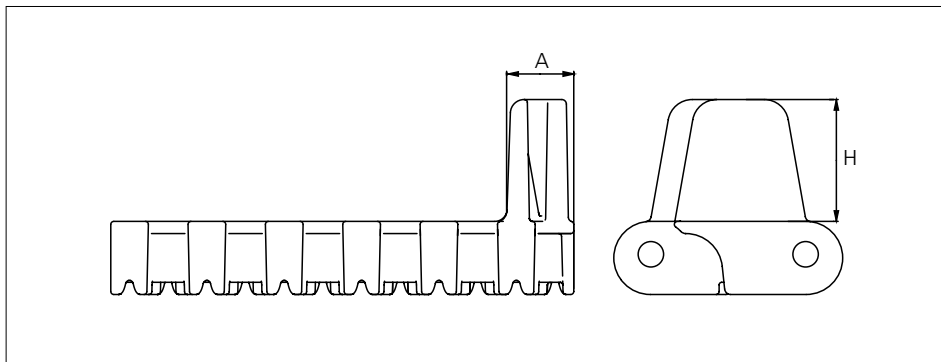

Type	Flight material & color	A		H		Link size	Width	
		mm	in	mm	in		mm	in
Side Guard	POM NL <span style="background-color: orange;">O</span>	23.0	0.91	40.0	1.57	K600	152.4	6.00

Backflex radius when side guards are used: 115 mm (4.53 in).

## Sprocket

No of teeth	Bore size						Overall diameter		Pitch diameter		Hub diameter		*A-dimension		B-dimension		Single row/Two way	Double row/Two way	Molded PA6 LG	Machined PA6 N
	Pilot bore	in	1.57	2.36	2.50	3.54														
	mm	40.0	60.0	63.5	90.0	120.0	mm	in	mm	in	mm	in	mm	in						
Z12	x		■		■		197.3	7.77	197.0	7.76	150.0	5.91	82.0	3.23	109.4	4.31		x	x	
Z16	x		■		■	■	263	10.35	261.4	10.29	200.0	7.87	115.0	4.53	141.5	5.57		x	x	x

\*A-dimension for automotive applications use A = (B-23.0 mm/0.91 in).

Non standard material and color:  
See uni Material and Color Overview.

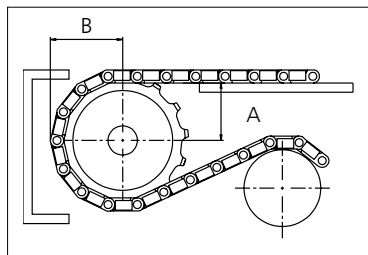
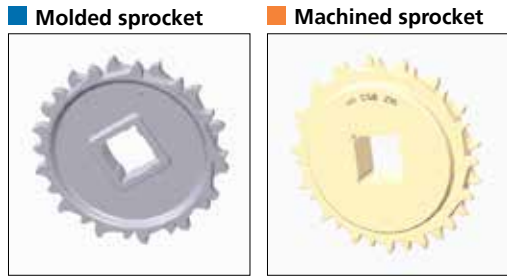

Other sprocket sizes are available upon request.  
Two-part sprockets are available upon request.  
Round bores are always delivered with keyway.  
Other bore sizes are available upon request.  
uni Retainer Rings: See uni Retainer Ring data sheet  
Width of single tooth = 10.0 mm (0.39 in)  
Width of sprocket = 50.0 mm (1.98 in)

Max load per sprocket shown does not take bore size into account.  
Please also ensure that sufficient size shaft is chosen for corresponding load.

For correct sprocket position: See uni Assembly Instructions for uni CSB.  
For more detailed sprocket information, contact Customer Service.

uni CSB C/170608



Expert advice, quality solutions and local service for all your belting needs  
[www.ammeraalbeltech.com](http://www.ammeraalbeltech.com)

**Ammeraal Beltech Modular A/S**  
Hjulmagervej 21  
DK-7100 Vejle

T +45 7572 3100  
F +45 7572 3348  
admin@unichains.com  
www.unichains.com

This information is subject to alteration due to continuous development. Ammeraal Beltech will not be held liable for the incorrect use of the above stated information. This information replaces previous information. All activities performed and services rendered by Ammeraal Beltech are subject to general terms and conditions of sale and delivery, as applied by its operating companies.





# Plastic Modular Belt

Series **uni CSB** Type **Rough**

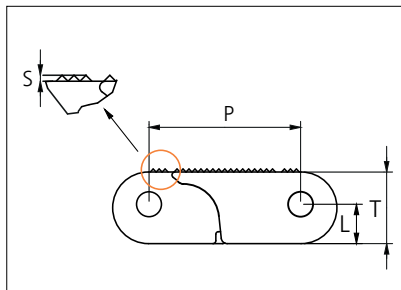

Straight running belt  
 Nominal pitch: 50.8 mm (2.00 in)  
 Surface type: Rough (R11)  
 Surface opening: Closed  
 Backflex radius: 100 mm (3.94 in)  
 Pin diameter: 8.0 mm (0.31 in)

Belt material & color	POM NL <b>K</b>	POX-FR <b>EG</b>	mm	in	mm	in		
Pin and lock material & color	PA6.6 <b>N</b> PP <b>O</b>	PBT <b>LG</b> PP <b>O</b>	P (Nominal)	50.8	2.00	T	24.0	0.94
			L	13.2	0.52	S	1.0	0.04

Non standard material and color: See uni Material and Color Overview.  
 Safety edges with orange or yellow edge links mounted on alternating pitches along both belt edges are optional.  
 Alternative pin and lock systems and materials: Contact Customer Service.

Belt width		Permissible tensile force (Belt/pin material)				***Belt weight (Belt/pin material)		Min No drive sprocket per shaft	Number of wear strips (min no)	
		POM NL/PA66 POX-FR/PBT		POM NL/SS POX-FR/SS		POM NL/PA66			**Carry (pcs)	**Return (pcs)
mm	in	N	lbf	N	lbf	Kg/m	lb/ft			
153	6.0	13725	3085	15250	3428	2.9	1.92	2	2	2
305	12.0	27450	6171	30500	6856	5.7	3.83	3	3	2
458	18.0	41177	9257	45753	10285	8.6	5.75	4	4	2
610	24.0	54905	12343	61005	13714	11.4	7.67	5	5	3
763	30.0	68632	15429	76258	17143	14.3	9.58	6	6	3
915	36.0	82360	18514	91511	20572	17.1	11.50	7	7	4
1068	42.0	96087	21600	106764	24000	20.0	13.42	8	8	4
1220	48.0	109815	24686	122016	27429	22.8	15.33	9	9	5
1373	54.0	123542	27772	137269	30858	25.7	17.25	10	10	5
1525	60.0	137269	30858	152522	34287	28.5	19.17	11	11	6
1678	66.1	150997	33944	167774	37716	31.4	21.08	12	12	6
1830	72.1	164724	37030	183027	41144	34.2	23.00	13	13	7

Additional standard belt widths are available in steps of 152.5 mm (6.00 in.) Additional non-standard belt widths are available in steps of 25.4 mm (1.00 in)

2898	114.1	260820	58632	289800	65147	54.2	36.42	20	20	10
------	-------	--------	-------	--------	-------	------	-------	----	----	----

Additional standard belt widths are available in steps of 152.5 mm (6.00 in.) Additional non-standard belt widths are available in steps of 25.4 mm (1.00 in)

3965	156.1	356850	80220	396500	89133	74.1	49.83	27	27	14
------	-------	--------	-------	--------	-------	------	-------	----	----	----

General belt tolerance is +0/-0.4% at 23°C/73°F and 50% RH. For exact belt width contact Customer Service. Non standard belt width on request.

Belt widths in POX FR is 1.0 % wider than the belt widths in the table above.

\*Max. Load per Drive Sprocket. Belt material: NL 6000 N (1349 lbf). PP 4000 N (899 lbf). POX FR 6000 N (1349 lbf).

\*\*Max. Spacing between wear strips. Carry: 152.0 mm (6.00 in); Return: 304.0 mm (12.00 in).

\*\*\*The weight of the belt with SS pins is 6.7 kg/m<sup>2</sup> (0.42 lb/ft<sup>2</sup>) higher than with PA66 pins.

\*\*\*The weight in POX FR is approximately 12% lower than the weight of NL.

□ = Single Link



STANDARD

STRAIGHT RUNNING

PITCH 50.8 MM/2.00 IN

## Accessories

### NON STANDARD – Rubber Top

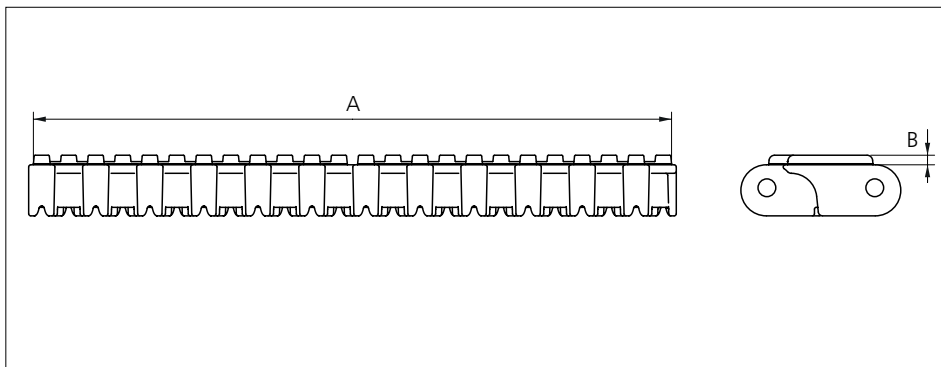

Type	Recommended belt material & color	Recommended rubber material & color	A		B		Link size	Width	
			mm	in	mm	in		mm	in
Flat Rib	PP <b>DG</b>	03 <b>K</b>	300.0	11.81	4.5	0.18	K1200	304.8	12.00

Backflex radius when flights are used: 200 mm (7.87 in).

## Accessories

### Top/Bottom Insert



+

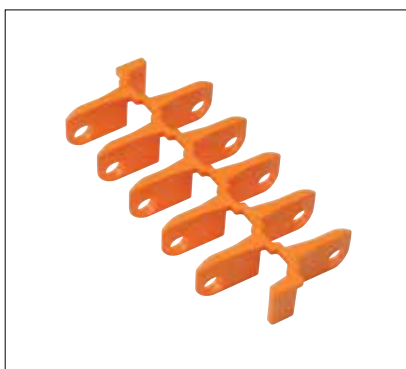

=



Type	Insert material & color	Weight	
		kg/m <sup>2</sup>	lb/ft <sup>2</sup>
Wheel Plate	POM DK <b>O</b>	4.7	0.97

Contact area/wear surface of belt will increase from 24% to 47% by the use of inserts.

## Accessories

### Top/Bottom Insert

EC insert in uni CSB 8% Rough type can be built in to uni CSB C to create an electrical conductive belt.



+



=



Type	Insert material & color	Weight	
		kg/m <sup>2</sup>	lb/ft <sup>2</sup>
Electrical Conductive	POX-FREC <b>K</b>	5.3	1.09

Contact area/wear surface of belt will increase from 24% to 47% by the use of inserts.  
POX-FREC holds a surface resistivity of 1x10<sup>3</sup> Ohm according to IEC 60093/ASTM D257.

## Accessories

### Flight

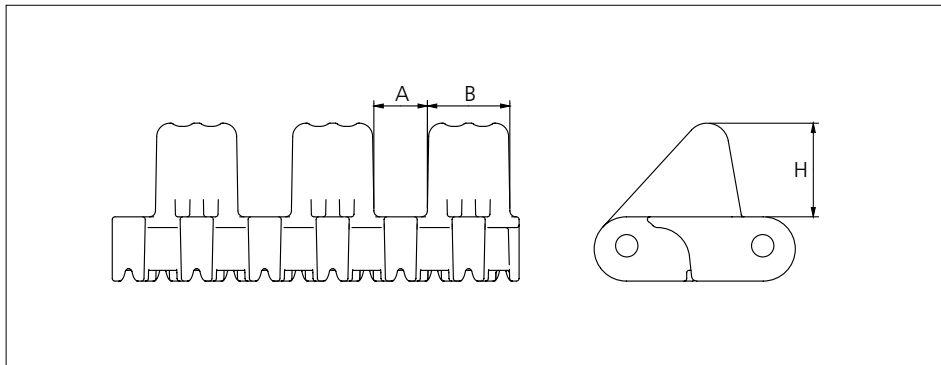

Type	Flight material & color	A		B		H		Link size	Width	
		mm	in	mm	in	mm	in		mm	in
Car Pusher	POM NL <span style="background-color: orange;">O</span>	20.0	0.79	31.0	1.22	35.0	1.38	K600	152.4	6.00

Backflex radius when flights are used: 200 mm (7.87 in).

## Accessories

### Flight

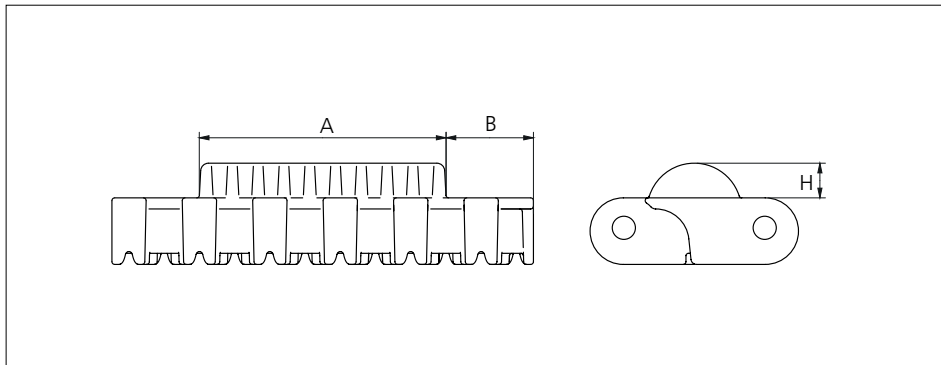

Type	Flight material & color	A		B		H		Link size	Width	
		mm	in	mm	in	mm	in		mm	in
Curved Flight	POM NL <span style="background-color: yellow;">Y</span>	89.0	3.50	31.5	1.24	12.5	0.49	K600	152.4	6.00

## Accessories

### Side Guard

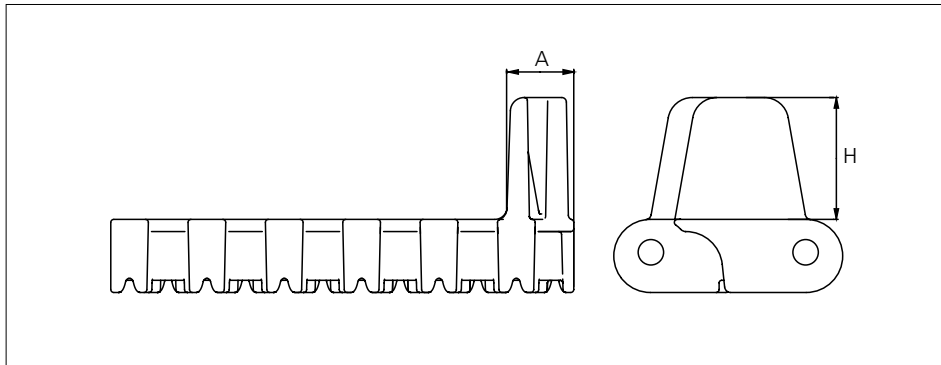

Type	Flight material & color	A		H		Link size	Width	
		mm	in	mm	in		mm	in
Side Guard	POM NL <span style="background-color: orange;">O</span>	23.0	0.91	40.0	1.57	K600	152.4	6.00

Backflex radius when side guards are used: 115 mm (4.53 in).

## Sprocket

No of teeth	Bore size							Overall diameter		Pitch-diameter		Hub-diameter		*A-dimension		B-dimension		Single row/Two way	Double row/Two way	Molded PA6 LG	Machined PA6 N
	Pilot bore	in	1.57	2.36	2.50	3.54	3.54														
	mm	40.0	60.0	63.5	90.0	120.0	mm	in	mm	in	mm	in	mm	in	mm	in					
Z12	x			■		■		197.3	7.77	197.0	7.76	150.0	5.91	82.0	3.23	109.4	4.31		x	x	
Z16	x			■		■	■	263	10.35	261.4	10.29	200.0	7.87	115.0	4.53	141.5	5.57		x	x	x

\*A-dimension for automotive applications use A = (B-23.0 mm/0.91 in).

Non standard material and color:  
See uni Material and Color Overview.

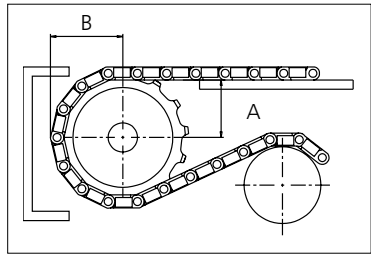
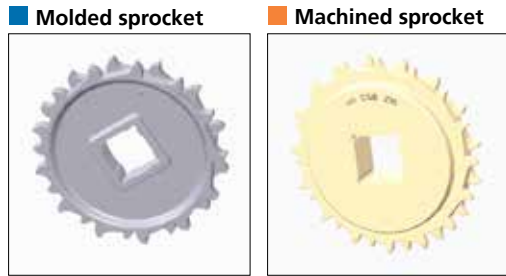

Other sprocket sizes are available upon request.  
Two-part sprockets are available upon request.  
Round bores are always delivered with keyway.  
Other bore sizes are available upon request.  
uni Retainer Rings: See uni Retainer Ring data sheet  
Width of single tooth = 10.0 mm (0.39 in)  
Width of sprocket = 50.0 mm (1.98 in)

Max load per sprocket shown does not take bore size into account.  
Please also ensure that sufficient size shaft is chosen for corresponding load.

For correct sprocket position: See uni Assembly Instructions for uni CSB.  
For more detailed sprocket information, contact Customer Service.

uni CSB Rough/170608



Expert advice, quality solutions and local service for all your belting needs  
[www.ammeraalbeltech.com](http://www.ammeraalbeltech.com)

**Ammeraal Beltech Modular A/S**  
Hjulmagervej 21  
DK-7100 Vejle

T +45 7572 3100  
F +45 7572 3348  
admin@unichains.com  
www.unichains.com

This information is subject to alteration due to continuous development. Ammeraal Beltech will not be held liable for the incorrect use of the above stated information. This information replaces previous information. All activities performed and services rendered by Ammeraal Beltech are subject to general terms and conditions of sale and delivery, as applied by its operating companies.



# Plastic Modular Belt

Series **uni ECB** Type **C**

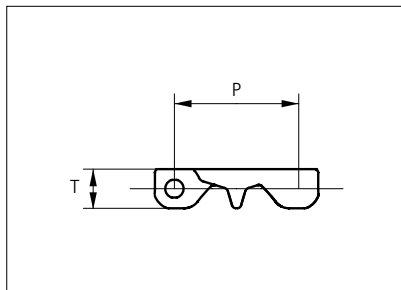

Straight running belt  
 Nominal pitch: 50.8 mm (2.00 in)  
 Surface type: Closed  
 Surface opening: 0%  
 Front- and backflex radius:  
 65.0 mm (2.60 in)  
 uni Snap link (pinless)

Belt material & color	POM SI <span style="border: 1px solid black; padding: 0 2px;">W</span>		mm	in		mm	in
		P (Nominal)	50.8	2.00	T	16.0	0.94

Non standard material and color: See uni Material and Color Overview.  
 POM-SI B is available as MTO and can be used as marker in belt.  
 Please note that uni ECB in POM-SI blue is not according to the standard color quality for blue. Small variations may occur.

Belt width			Permissible tensile force (Belt material)		Weight (Belt material)		Min No drive sprocket per shaft	Number of wear strips (min no)	
			POM-SI		POM-SI			**Carry (pcs)	**Return (pcs)
	mm	in	N	lb	kg/m	lb/ft			
K1600	402	15.8	4400	899	5.0	3.36	3	3	2
K1800	452	17.8	5500	1236	6.2	4.44	4	4	2
K2000	501	19.8	5500	1236	6.6	4.17	4	4	2
K2400	603	23.7	6600	1484	7.5	5.04	5	5	3
K3000	754	29.7	7700	1731	9.3	6.25	6	6	3
K3200	806	31.7	8800	1978	10.0	6.72	6	6	3

General belt tolerance is +0/-0.4% at 23°C/73°F.  
 \*Max. Load per Drive Sprocket. Belt material: 1500 N (337 lbf).  
 \*\*Max. Spacing between wear strips, Carry: 152.0 mm (6.00 in); Return: 304.0 mm (12.00 in).  
 All materials are FDA approved for use with food contact. uni ECB complies to the following standards; EC 1935/2004, EU 10/2011, NSF/ANSI/3-A STANDARD 14159-1.  
 Material temperature range: -40 to +90°C (-40 to +194°F).  
 Non standard belt widths: K1600/K2400/K3200 can be bricked to make higher belt widths.  
 Non standard belt widths is not recommended by uni-chains because of cleanability.

= Single Link



STANDARD

STRAIGHT RUNNING

PITCH 50.8 MM/2.00 IN

## Sprocket

No of teeth	Bore size								Overall diameter		Pitch-diameter		Hub-diameter		*Dimension A		Dimension B		Single row/One way	Molded	PA6 LG
	Pilot bore																				
	mm	in	1.00	1.18	1.25	1.50	1.57	2.36	2.50	mm	in	mm	in	mm	in	mm	in				
Z08	✓		●	●	●	■	■			132.9	5.23	132.8	5.23	65	2.56	53.3	2.10	74.9	2.95	✓	✓
Z10	✓			●	●	■	■			166.3	6.55	164.4	6.47	65	2.56	70.2	2.76	90.7	3.57	✓	✓
Z10								■	■	166.3	6.55	164.4	6.47	120	4.72	70.2	2.76	90.7	3.57	✓	✓
Z12	✓			●	●	■	■			198.6	7.82	196.3	7.73	65	2.56	86.8	3.42	106.6	4.20	✓	✓
Z12								■	■	198.6	7.82	196.3	7.73	120	4.72	86.8	3.42	106.6	4.20	✓	✓
Z16	✓			●	●	■	■	■	■	263.8	10.39	260.4	10.25	150	5.90	119.7	4.71	138.7	5.46	✓	✓

■ Molded sprocket ● Molded sprocket

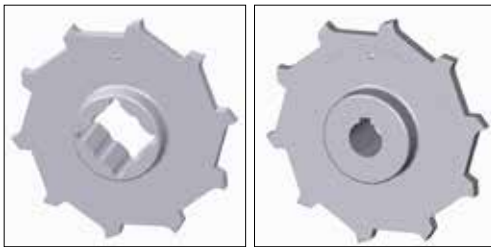

Other sprocket sizes are available upon request.  
 Other bore sizes on sprockets are available upon request.  
 Round bores are always delivered with keyway.  
 Max. load per sprocket shown does not take bore size into account.  
 Please also ensure that sufficient size shaft is chosen for corresponding load.  
 Width of tooth = Single row 9.5 mm (0.37 in)  
 Width of One-part sprocket = Single row: 42.3 mm (1.67 in)

Non standard material and color: See uni Material and Color Overview.

## uni UltraClean Two-Part Sprocket

No. of teeth	Bore size				Overall diameter		Pitch-diameter		Hub-diameter		Dimension A		Dimension B		Single row/One way	Molded	PA6 W
	in	1.50	1.57	2.36													
	mm	38.1	40.0	60.0	mm	in	mm	in	mm	in	mm	in	mm	in			
Z8		■	■		132.9	5.23	132.8	5.23	80.0	3.15	53.3	2.10	74.9	2.94	✓	✓	
Z10		1 ■	1 ■	2 ■	166.3	6.55	164.4	6.47	1126.0 2118.0	14.96 24.65	70.2	2.76	90.7	3.57	✓	✓	
Z12		1 ■	1 ■	2 ■	198.6	7.82	196.3	7.73	1126.0 2118.0	14.96 24.65	86.8	3.42	106.6	4.19	✓	✓	

■ Molded uni UltraClean TwoPart Sprocket

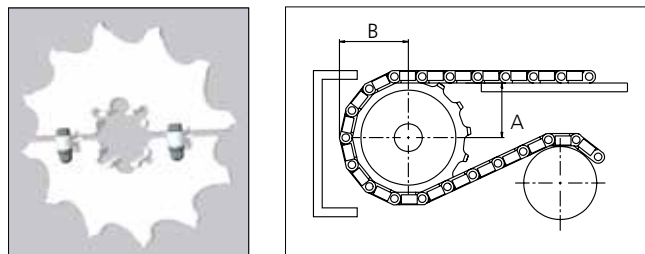

Width of UltraClean Two-part sprocket = Single row: 44.0 mm (1.73 in)  
 Width of UltraClean Two-part sprocket, tooth = Single row: 9.5 mm (0.37 in)

uni Retainer Rings: See uni Retainer Ring data sheet.  
 For correct sprocket position: See uni Assembly Instructions for uni ECB.  
 For more detailed sprocket information. contact Customer Service.



Expert advice, quality solutions and local service for all your belting needs  
[www.ammeraalbeltech.com](http://www.ammeraalbeltech.com)

**Ammeraal Beltech Modular A/S**  
 Hjulmagervej 21  
 DK-7100 Vejle

T +45 7572 3100  
 F +45 7572 3348  
 admin@unichains.com  
 www.unichains.com

This information is subject to alteration due to continuous development. Ammeraal Beltech will not be held liable for the incorrect use of the above stated information. This information replaces previous information. All activities performed and services rendered by Ammeraal Beltech are subject to general terms and conditions of sale and delivery, as applied by its operating companies.



# Plastic Modular Belt

Series **uni JCB** Type **Y-Top**

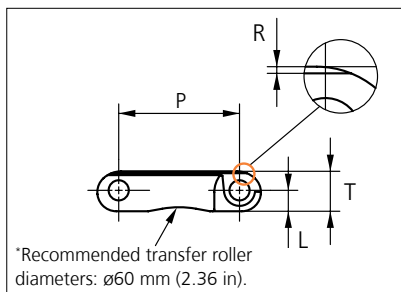
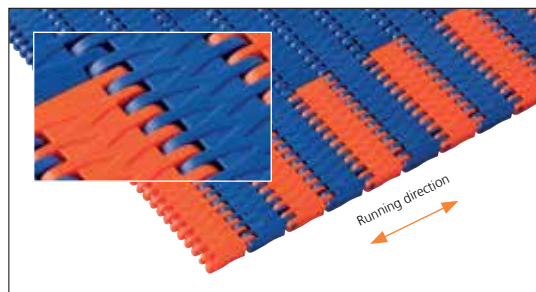

Straight running belt  
 Nominal pitch: 25.4 mm (1.00 in)  
 Surface type: Y Pattern surface grid  
 Surface opening: 0%  
 Backflex radius: 25.0 mm (0.98 in)  
 Pin diameter: 4.0 mm (0.16 in)

<b>Belt material &amp; color</b>	POM SLF <b>B</b>
<b>Pin material &amp; color</b>	PA6.6 <b>B</b> PA6.6 <b>B</b> *

	mm	in		mm	in
<b>P (Nominal)</b>	25.4	1.00	<b>T</b>	8.4	0.33
<b>L</b>	4.4	0.17	<b>R</b>	0.4	0.02

POM SLF orange or yellow links can be used as SAFE WALK markers.  
 \*Only for K200 / K300 chain

Belt width		Permissible tensile force (Belt/pin material)		Belt weight (Belt/pin material)		*Min No drive sprocket per shaft	Number of wear strips (min no)	
		POM SLF/PA6.6		POM SLF/PA6.6			***Carry (pcs)	**Return (pcs)
mm	in	N	lbf	kg/m	lb/ft			
51 (chain)	2.0	1785	401	0.3	0.22	1	2	2
77 (chain)	3.0	2695	606	0.5	0.34	1	2	2
153	6.0	5355	1204	1.0	0.67	2	2	2
229	9.0	8015	1802	1.5	1.00	2	2	2
305	12.0	10675	2400	2.0	1.33	3	3	2
381	15.0	13335	2998	2.5	1.66	3	3	2
457	18.0	15995	3596	3.0	2.00	4	4	2
533	21.0	18655	4194	3.5	2.33	4	4	2
609	24.0	21315	4792	4.0	2.66	5	5	3
685	27.0	23975	5390	4.5	2.99	5	5	3
761	30.0	26635	5988	4.9	3.32	6	6	3
837	33.0	29295	6586	5.4	3.66	6	6	3
913	35.9	31955	7183	5.9	3.99	7	7	4

Standard Increments in belt width: 76.3 mm (3.00 in).

1978	77.9	69230	15563	12.9	8.64	14	14	7
------	------	-------	-------	------	------	----	----	---

Standard Increments in belt width: 76.3 mm (3.00 in).

2966	116.8	103810	23336	19.3	12.96	20	20	10
------	-------	--------	-------	------	-------	----	----	----

General belt tolerance is +0/-0.4% at 23°C/73°F and 50% RH. For exact belt width contact Customer Service. Non standard belt width on request.

\*Max. Load per Drive Sprocket. Belt material: POM-SLF 2300 N (517 lbf).

\*\*Max. Spacing between wear strips, Carry: 152.0 mm (6.00 in); Return: 304.0 mm (12.00 in).

\*\*\*Full Carry way Support (FS) deck of wearstrip material recommended for safe walk belts.

= Single Link



STANDARD

STRAIGHT RUNNING

PITCH 25.4 MM/1.00 IN

## Sprocket

No. of teeth	Bore size										Overall diameter		Pitch diameter		Hub diameter		Dimension A		Dimension B		Single row/Two way	Moulded	PA6 LG
	Pilot bore	in	1.00	1.18	1.25	1.50	1.57	2.36	2.50														
	mm	25.4	30.0	31.8	38.1	40.0	60.0	63.5	mm	in	mm	in	mm	in	mm	in	mm	in					
Z10	✓		●	●	●	■	●			80.3	3.16	82.2	3.24	65.0	2.56	34.7	1.36	45.5	1.79	✓	✓		
Z12	✓		●	●	●	■	■			96.8	3.81	98.1	3.86	70.0	2.76	43.0	1.69	53.5	2.11	✓	✓		
Z15	✓			●	●	■	■	■	■	121.5	4.78	122.2	4.81	<sup>1</sup> 70.0 <sup>1</sup> 100.0 <sup>2</sup> 104.0	2.76 13.94 4.09	55.4	2.18	65.5	2.58	✓	✓		
Z18	✓			●	●	■	■	■	■	146.0	5.75	146.3	5.76	<sup>1</sup> 70.0 <sup>1</sup> 120.0 <sup>2</sup> 104.0	2.76 4.72 4.09	67.6	2.66	77.5	3.05	✓	✓		
Z19	✓			●	●	■	■	■	■	154.2	6.07	154.3	6.07	<sup>1</sup> 70.0 <sup>1</sup> 120.0 <sup>2</sup> 104.0	2.76 4.72 4.09	71.7	2.82	81.6	3.21	✓	✓		

● Moulded sprocket ■ Moulded sprocket ■ Moulded sprocket



Other sprocket sizes are available upon request.  
 Round bores are always delivered with keyway.  
 Max load per sprocket shown does not take bore size into account.  
 Please also ensure that sufficient size shaft is chosen for corresponding load.  
 Other bore sizes are available upon request.  
 uni Retainer Rings: See uni Retainer Ring data sheet.  
 Width of tooth = 10.0 mm (0.39 in)  
 Width of OnePart sprocket = 25.0 mm (0.98 in)

## uni UltraFit Two-Part Sprocket

No. of teeth	Bore size					Overall diameter		Pitch diameter		Hub/adaptor diameter		Hub/adaptor width		Dimension A		Dimension B		Single row/Two way	Moulded	PA6 LG	Adapter Moulded	POM-D B
	in	1.50	1.57	2.36	2.50																	
	mm	38.1	40.0	60.0	63.5	mm	in	mm	in	mm	in	mm	in	mm	in	mm	in					
Z12		■	■			96.8	3.81	98.2	3.87	83.0	3.27	25.0 76.0	0.98 2.99	43	1.69	53.5	2.11	✓	✓	✓	✓	
Z13		■	■			104.8	4.13	106.2	4.18	83.0	3.27	25.0 76.0	0.98 2.99	47.1	1.86	57.1	2.25	✓	✓	✓	✓	
Z15		■	■	■	■	121.5	4.78	122.5	4.82	106.0	4.14	25.0 76.0	0.98 2.99	55.4	2.18	65.5	2.58	✓	✓	✓	✓	
Z16		■	■	■	■	129.7	5.11	130.2	5.13	106.0	4.14	25.0 76.0	0.98 2.99	59.5	2.35	69.5	2.74	✓	✓	✓	✓	
Z18		■	■	■	■	146.1	5.75	146.3	5.76	106.0	4.14	25.0 76.0	0.98 2.99	67.6	2.66	77.5	3.05	✓	✓	✓	✓	
Z19		■	■	■	■	154.2	6.07	154.3	6.07	106.0	4.14	25.0 76.0	0.98 2.99	71.7	2.82	81.6	3.21	✓	✓	✓	✓	

■ Moulded uni UltraFit TwoPart Sprocket (Narrow adapter) ■ Moulded uni UltraFit TwoPart Sprocket (Wide adapter)

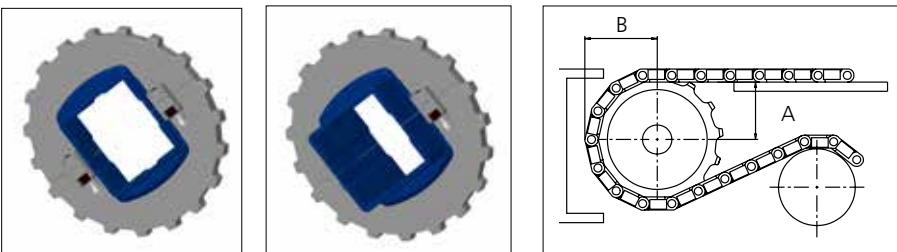

For correct sprocket position:  
 See uni Assembly Instructions for uni QNB.  
 For more detailed sprocket information contact Customer Service.

uni JCB Y-Top/181008



This information is subject to alteration due to continuous development. Ammeraal Beltech will not be held liable for the incorrect use of the above stated information. This information replaces previous information. All activities performed and services rendered by Ammeraal Beltech are subject to general terms and conditions of sale and delivery, as applied by its operating companies.

Expert advice, quality solutions and local service for all your belting needs  
[www.ammeraalbeltech.com](http://www.ammeraalbeltech.com)

**Ammeraal Beltech Modular A/S**  
 Hjulmagervej 21  
 DK-7100 Vejle

T +45 7572 3100  
 F +45 7572 3348  
 admin@unichains.com  
 www.unichains.com





# Plastic Modular Belt

Serie **uni L-SNB** Type **36%**

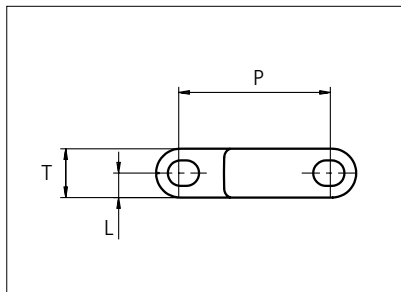

Straight Running  
 Nominal pitch: 50.0 mm (1.97 in)  
 Surface type: Flat  
 Surface opening: 36%  
 Backflex radius: 70.0 mm (2.80 in)  
 Pin diameter: 8.0 mm (0.31 in)

<b>Belt material &amp; color</b>	PP <b>W</b>		<b>mm</b>	<b>in</b>		<b>mm</b>	<b>in</b>
<b>Pin and lock material &amp; color</b>	PP <b>W</b> PP <b>W</b>	<b>P (Nominal)</b>	50.0	1.97	<b>L</b>	8.0	0.31
		<b>T</b>	16.0	0.63	-	-	-

Non standard material and color: See uni Material and Color Overview.

Alternative pin and lock materials: Pin: PE **W** SS304 PP **G**

Belt width		Permissible tensile force (Belt/pin material)		Belt weight (Belt/pin material)		*Min. No. drive sprocket per shaft	Number of wear strips (Min. No.)	
		PP		PP			**Carry (pcs)	**Return (pcs)
mm	in	N	lbf	kg/m	lb/ft			
153	6.0	2678	602	1.5	1.01	2	2	2
229	9.0	4009	901	2.2	1.51	2	2	2
305	12.0	5340	1200	3.0	2.01	3	3	2
381	15.0	6671	1500	3.7	2.51	3	3	2
457	18.0	8003	1799	4.5	3.01	4	4	2
533	21.0	9334	2098	5.2	3.51	4	4	2
609	24.0	10665	2398	6.0	4.01	5	5	3
686	27.0	11996	2697	6.7	4.51	5	5	3
762	30.0	13328	2996	7.5	5.02	6	6	3
838	33.0	14659	3295	8.2	5.52	6	6	3
914	36.0	15990	3595	9.0	6.02	7	7	4
990	39.0	17322	3894	9.7	6.52	7	7	4

Additional standard belt widths are available in steps of 76.1 mm (3.00 in).

1980	78.0	34650	7789	19.4	13.04	14	14	7
------	------	-------	------	------	-------	----	----	---

Additional standard belt widths are available in steps of 76.1 mm (3.00 in).

2969	116.9	51958	11680	29.1	19.55	20	20	10
------	-------	-------	-------	------	-------	----	----	----

General belt tolerance is +0/-0.4% at 23°C/73°F and 50% RH. For exact belt width contact Customer Service. Non standard belt width on request.

\*Max. Load per Drive Sprocket. Belt material PP with snub roller 2000 N (450 lbf), PP without snub roller 1250 N (281 lbf)

\*\*Max. Spacing between wear strips, Carry: 152 mm (6 in); Return: 304 mm (12 in)

\*\*\*Load capacity per row of reinforcement links in the belt: 2500 N (562 lbf)

\*\*\*Example: Belt with 8 rows of reinforcement links, permissible load is 8 x 2500 N (562 lbf) = 20000 N (4496 lbf)

= Single Link



STANDARD

STRAIGHT RUNNING

PITCH 50.0 MM/1.97 IN

## Accessories

### Reinforcement Link

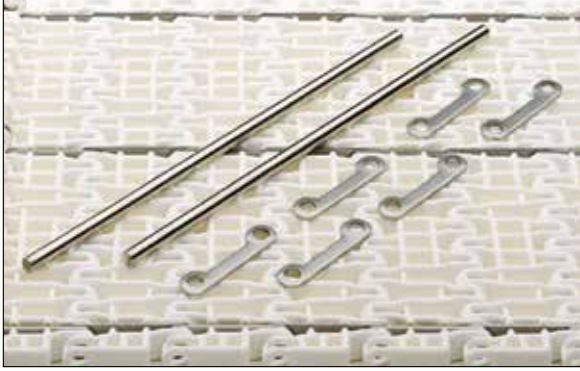

The use of uni-chains belts with the SS reinforcement /pitch control links in blanchers, cookers and other high temperature applications will reduce belt elongation due to temperature by more than 90%. This will simplify the belt take-up system and reduce maintenance.

uni-chains recommends three reinforcement links per K1200 module.

Note: Reinforcement links require the use of SS pins.

Type	Material & color	N/row	Lbf/row
Steel Link	SS316	2500	562

Non Standard material and color: See uni Material and Color Overview.

## Sprocket

No of teeth	Bore size													Overall diameter		Pitch-diameter		Hub-diameter		A-dimension		B-dimension		Single row/One way	Double row/Two way	Material	
	Pilot bore		0.75	0.78	0.98	1.00	1.18	1.25	1.50	1.57	2.36	2.50	3.54													mm	in
	mm	in												PA6	PA6 LG												
Z06	x					●	●	■	●					92.5	3.64	100.0	3.94	70.0	2.76	35.3	1.39	58.0	2.28	x		x	
Z08	x					●	●	■	●					128.7	5.07	130.7	5.15	70.0	2.76	52.4	2.06	73.3	2.89	x		x	
Z10	x					●	●	■	●					159.8	6.29	161.8	6.37	70.0	2.76	68.9	2.71	88.9	3.50	x		x	
Z10												■		159.8	6.29	161.8	6.37	120.0	4.72	68.9	2.71	88.9	3.50	x			x
Z12	x					●		■	●					192.5	7.58	193.2	7.61	70.0	2.76	85.3	3.36	104.6	4.12	x		x	
Z12												■		192.5	7.58	193.2	7.61	120.0	4.72	85.3	3.36	104.6	4.12	x			x
Z16	x					●		■	●			■		257.3	10.13	256.3	10.09	120.0	4.72	117.7	4.63	126.1	4.96	x			x

■ Molded sprocket

● Molded sprocket

■ Machined sprocket

● Machined sprocket

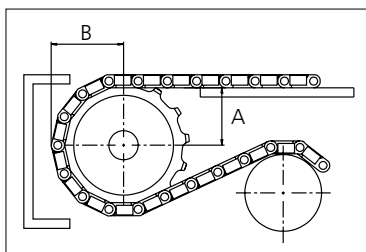

Other sprocket sizes are available upon request.  
 Two-part sprocket are available upon request.  
 Round bores are always delivered with keyway.  
 Other bore sizes are available upon request.  
 uni Retainer Rings: See uni Retainer Ring data sheet  
 Width of tooth = 7.0 mm (0.28 in)  
 Width of sprocket = 42.3 mm (1.67 in)

Max load per sprocket shown does not take bore size into account.  
 Please also ensure that sufficient size shaft is chosen for corresponding load.

For correct sprocket position: See uni Assembly Instructions for uni L-SNB.  
 For more detailed sprocket information, contact Customer Service.

Non standard material and color: See uni Material and Color Overview.



Conveyor Belts



Seamless Belts



Modular Belts



Timing Belts



Transmission Belts



Fabrication & service

Expert advice, quality solutions and local service for all your belting needs [www.ammeraalbeltech.com](http://www.ammeraalbeltech.com)

**Ammeraal Beltech Modular A/S**  
Hjulmagervej 21  
DK-7100 Vejle

T +45 7572 3100  
F +45 7572 3348  
admin@unichains.com  
www.unichains.com

This information is subject to alteration due to continuous development. Ammeraal Beltech will not be held liable for the incorrect use of the above stated information. This information replaces previous information. All activities performed and services rendered by Ammeraal Beltech are subject to general terms and conditions of sale and delivery, as applied by its operating companies.



# Plastic Modular Belt

Serie **uni L-SNB** Type **Rib 36%**

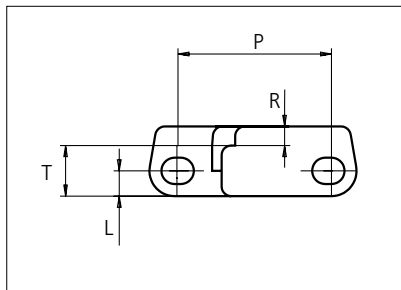

Straight running belt  
 Nominal pitch: 50.0 mm (1.97 in)  
 Surface type: Rib Top  
 Surface opening: 36%  
 Backflex radius: 140.0 mm (5.50 in)  
 Pin diameter: 8.0 mm (0.31 in)

Belt material & color	PP <b>G</b>	PP-HW <b>LB</b>	mm	in	mm	in		
	Pin and lock material & color	PP <b>W</b> PP <b>G</b>					PP-HW <b>LB</b> PP-HW <b>LB</b>	
			<b>P (Nominal)</b>	50.0	1.97	<b>T</b>	16.0	0.63
			<b>R</b>	6.0	0.23	<b>L</b>	8.0	0.31

Non standard material and color: See uni Material and Color Overview.

Alternative pin and lock materials: Pin: PE **W** SS304

Belt width		Permissible tensile force (Belt/pin material)		Belt weight (Belt/pin material)		*Min. No. drive sprocket per shaft	Number of wear strips (Min. No.)	
		PP-HW/PP		PP-HW/PP			**Carry (pcs)	**Return (pcs)
mm	in	N	lbf	kg/m	lb/ft			
153	6.0	4559	1025	1.5	1.01	2	2	2
229	9.0	6826	1535	2.2	1.51	2	2	2
305	12.0	9093	2044	3.0	2.01	3	3	2
381	15.0	11360	2554	3.7	2.51	3	3	2
457	18.0	13627	3063	4.5	3.01	4	4	2
533	21.0	15894	3573	5.2	3.51	4	4	2
609	24.0	18161	4083	6.0	4.01	5	5	3
686	27.0	20428	4592	6.7	4.51	5	5	3
762	30.0	22695	5102	7.5	5.02	6	6	3
838	33.0	24962	5611	8.2	5.52	6	6	3
914	36.0	27229	6121	9.0	6.02	7	7	4
990	39.0	29496	6631	9.7	6.52	7	7	4

Additional standard belt widths are available in steps of 76.1 mm (3.00 in)

1980	78.0	59004	13264	19.4	13.04	14	14	7
------	------	-------	-------	------	-------	----	----	---

Additional standard belt widths are available in steps of 76.1 mm (3.00 in)

2969	116.9	88476	19889	29.1	19.55	20	20	10
------	-------	-------	-------	------	-------	----	----	----

General belt tolerance is +0/-0.4% at 23°C/73°F and 50% RH. For exact belt width contact Customer Service. Non standard belt width on request.

\*Max. Load per Drive Sprocket. Belt material: PP-HW with snub roller 2000 N (450 lbf), PP-HW without snub roller 1250 N (281 lbf)

\*\*Max. Spacing between wear strips, Carry: 152 mm (6 in.) ; Return: 304 mm (12 in.)

\*\*\*Load capacity per row of reinforcement links in the belt: 2500 N (562 lbf)

\*\*\*Example: Belt with 8 rows of reinforcement links, permissible load is 8 x 2500 N (562 lbf) = 20000 N (4496 lbf)

□ = Single Link



STANDARD

STRAIGHT RUNNING

PITCH 50.0 MM/1.97 IN

## Accessories

### Reinforcement Link



The use of uni-chains belts with the SS reinforcement /pitch control links in blanchers, cookers and other high temperature applications will reduce belt elongation due to temperature by more than 90%. This will simplify the belt take-up system and reduce maintenance. uni-chains recommends three reinforcement links per K1200 module.  
Note: Reinforcement links require the use of SS pins.

Type	Material & color	N/row	Lbf/row
Steel Link	<b>SS316</b>	2500	562

Non Standard material and color: See uni Material and Color Overview.

## Accessories

### Finger Plates

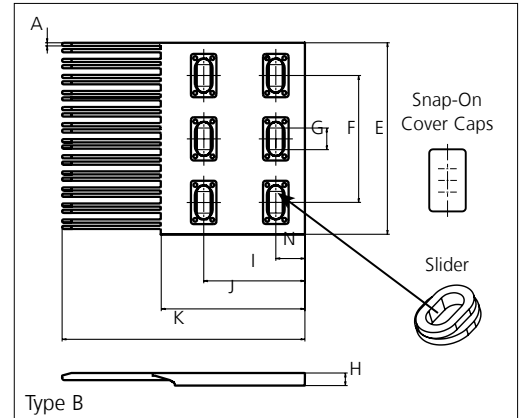
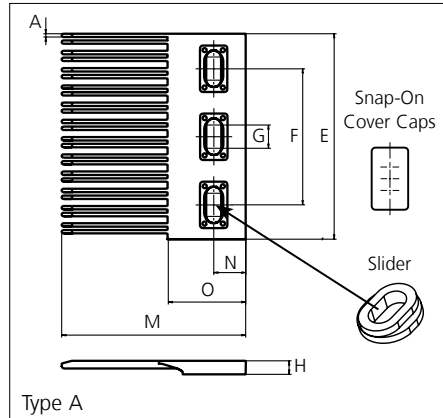
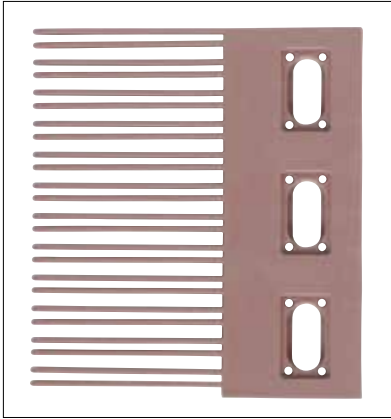

Type	Material & color	A		E		F		G							
		mm	in	mm	in	mm	in	mm	in						
Single Sided 150x149	POM-LF <b>BR</b> POM-DI <b>G</b>	2.5	0.10	152.1	5.99	100.3	3.95	12.0	0.47						
Single Sided 120x149															
		H		I		J		K		M		N		O	
mm	in	mm	in	mm	in	mm	in	mm	in	mm	in	mm	in	mm	in
10.0	0.39	80.0	3.15	114.0	4.49	192.0	7.56	135.0	5.31	23.0	0.91	57.0	6.18		

All uni-chains belt systems are available in a raised rib version that can be supplied with matching finger plates, also called combs.

The finger plates are supplied with cover caps which can be attached when the finger plate has been installed. The cover caps can be removed by using a screwdriver that can be inserted between the cover and finger plate. In order to adjust to belt width variations caused by temperature fluctuations, a slider facilitates the sideways movement of the finger plates.

Non Standard material and color: See uni Material and Color Overview.

# Sprocket

No of teeth	Bore size													Overall diameter		Pitch-diameter		Hub-diameter		A-dimension		B-dimension		Single row/One way	Double row/Two way	Material		
	Pilot bore	mm	in	0.75	0.78	0.98	1.00	1.18	1.25	1.50	1.57	2.36	2.50													3.54	mm	in
														PA6	PA6 LG													
Z06	x							●	●	■	●				92.5	3.64	100.0	3.94	70.0	2.76	35.3	1.39	58.0	2.28	x		x	
Z08	x							●	●	■	●				128.7	5.07	130.7	5.15	70.0	2.76	52.4	2.06	73.3	2.89	x		x	
Z10	x							●	●	■	●				159.8	6.29	161.8	6.37	70.0	2.76	68.9	2.71	88.9	3.50	x		x	
Z10													■	159.8	6.29	161.8	6.37	120.0	4.72	68.9	2.71	88.9	3.50	x			x	
Z12	x							●		■	●				192.5	7.58	193.2	7.61	70.0	2.76	85.3	3.36	104.6	4.12	x		x	
Z12													■	192.5	7.58	193.2	7.61	120.0	4.72	85.3	3.36	104.6	4.12	x			x	
Z16	x							●	■	●			■	257.3	10.13	256.3	10.09	120.0	4.72	117.7	4.63	126.1	4.96	x			x	

■ Molded sprocket

● Molded sprocket

■ Machined sprocket

● Machined sprocket

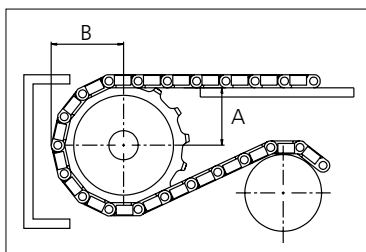

Other sprocket sizes are available upon request.  
 Two-part sprocket are available upon request.  
 Round bores are always delivered with keyway.  
 Other bore sizes are available upon request.  
 uni Retainer Rings: See uni Retainer Ring data sheet  
 Width of tooth = 7.0 mm (0.28 in)  
 Width of sprocket = 42.3 mm (1.67 in)

Max load per sprocket shown does not take bore size into account.  
 Please also ensure that sufficient size shaft is chosen for corresponding load.

For correct sprocket position: See uni Assembly Instructions for uni L-SNB.  
 For more detailed sprocket information, contact Customer Service.

Non standard material and color: See uni Material and Color Overview.



Conveyor Belts



Seamless Belts



Modular Belts



Timing Belts



Transmission Belts



Fabrication & service

Expert advice, quality solutions and local service for all your belting needs [www.ammeraalbeltech.com](http://www.ammeraalbeltech.com)

**Ammeraal Beltech Modular A/S**  
Hjulmagervej 21  
DK-7100 Vejle

T +45 7572 3100  
F +45 7572 3348  
admin@unichains.com  
www.unichains.com

This information is subject to alteration due to continuous development. Ammeraal Beltech will not be held liable for the incorrect use of the above stated information. This information replaces previous information. All activities performed and services rendered by Ammeraal Beltech are subject to general terms and conditions of sale and delivery, as applied by its operating companies.





# Plastic Modular Belt

Series **uni Light** Type **C**

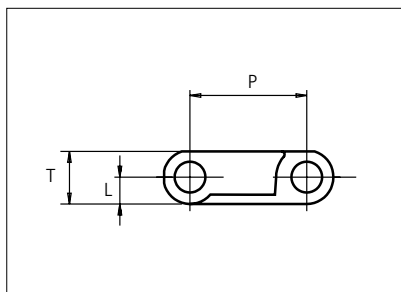

Straight running belt  
 Nominal pitch: 19.1 mm (0.75 in)  
 Surface type: Flat  
 Surface opening: Closed  
 Backflex radius: 25.0 mm (2.0 in)  
 Pin diameter: 5.0 mm (0.20 in)

Belt material & color	POM-LF <b>BR</b>	PP <b>W G K</b>	PP <b>B</b>	PA6 <b>K</b>													
Pin and lock material & color	PP <b>W</b>	PP <b>W</b>	PP <b>B</b>	PBT-GR <b>N</b> PP <b>G</b>													
					<b>P (Nominal)</b>	19.1	0.75	<b>T</b>	8.5	0.33							
					<b>L</b>	4.3	0.17	-	-	-							

Non standard material and color: See uni Material and Color Overview.

Alternative pin and lock materials: Pin: PE **W** PP **W** PA6.6 **N B** PBT **LG** SS304 PP **W** Lockpin: PBT **LG** PA6.6 **D N** PP **W B**

Belt width		Permissible tensile force (Belt/pin material)						Belt weight (Belt/pin material)						*Min. No. drive sprocket per shaft	Number of wear strips (Min. No.)	
		POM-LF/PP		PP/PP		PA6/PBT-GR		POM-LF/PP		PP/PP		PA6/PBT-GR			**Carry (pcs)	**Return (pcs)
mm	in	N	lbf	N	lbf	N	lbf	kg/m	lb/ft	kg/m	lb/ft	kg/m	lb/ft			
58	2.3	595	134	297	67	595	134	0.4	0.27	0.3	0.19	0.3	0.22	2	2	2
77	3.0	789	177	395	89	789	177	0.5	0.35	0.4	0.25	0.4	0.29	2	2	2
115	4.5	1175	264	587	132	1175	264	0.8	0.52	0.6	0.37	0.6	0.43	2	2	2
153	6.0	1572	353	786	177	1572	353	1.0	0.70	0.7	0.49	0.9	0.58	2	2	2
230	9.0	2355	529	1177	265	2355	529	1.6	1.05	1.1	0.74	1.3	0.86	2	2	2
306	12.1	3138	705	1569	353	3138	705	2.1	1.40	1.5	0.99	1.7	1.15	3	3	2
383	15.1	3921	881	1960	441	3921	881	2.6	1.75	1.8	1.23	2.1	1.44	3	3	2
459	18.1	4704	1057	2352	529	4704	1057	3.1	2.10	2.2	1.48	2.6	1.73	4	4	2
535	21.1	5486	1233	2743	617	5486	1233	3.6	2.45	2.6	1.73	3.0	2.01	4	4	2
612	24.1	6269	1409	3135	705	6269	1409	4.2	2.80	2.9	1.97	3.4	2.30	5	5	3
688	27.1	7052	1585	3526	793	7052	1585	4.7	3.14	3.3	2.22	3.9	2.59	5	5	3
764	30.1	7835	1761	3918	881	7835	1761	5.2	3.49	3.7	2.47	4.3	2.88	6	6	3
841	33.1	8618	1937	4309	969	8618	1937	5.7	3.84	4.0	2.71	4.7	3.16	6	6	3

Additional standard belt widths are available in steps of 76.4 mm (3.01 in). Additional non-standard belt widths are available in steps of 19.1 mm (0.75 in).

1910	75.2	19578	4401	9789	2201	19578	4401	13.0	8.73	9.2	6.16	10.7	7.19	13	13	7
------	------	-------	------	------	------	-------	------	------	------	-----	------	------	------	----	----	---

Additional standard belt widths are available in steps of 76.4 mm (3.01 in). Additional non-standard belt widths are available in steps of 19.1 mm (0.75 in).

2980	117.3	30545	6867	15273	3433	30545	6867	20.3	13.62	14.3	9.61	16.7	11.22	20	20	10
------	-------	-------	------	-------	------	-------	------	------	-------	------	------	------	-------	----	----	----

General belt tolerance is +0/-0.4% at 23°C/73°F and 50% RH. For exact belt width contact Customer Service. Non standard belt width on request.

The belt width in PA6 is 0.8 % wider than the belt width in the table

\*Max. Load per Drive Sprocket. Belt material: POM-LF 1250 N (281 lbf), PP 700 N (157 lbf), PA6 1250 N (281 lbf)

\*\*Max. Spacing between wear strips, Carry: 152.0 mm (6.00 in); Return: 304.0 mm (12.00 in)

= Single Link



STANDARD

STRAIGHT RUNNING

PITCH 19.1 MM/0.75 IN

## Accessories

### Rubber Top

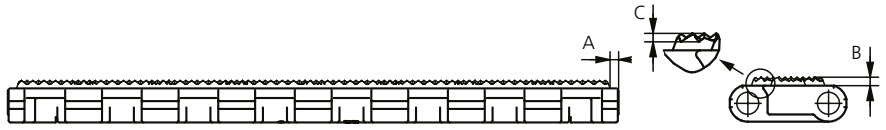

Type	Belt Material & color	Rubber Material & color	A		B		C		Link size	Width	
			mm	in	mm	in	mm	in		mm	in
NON STANDARD Flat	PP <b>K</b>	03 <b>K</b>	2.0	0.08	2.0	0.08	-	-	K300	76.0	2.99
STANDARD Rough							1.0	0.04	K450	114.0	4.49
									K600	150.5	5.93

Indent 15.0 mm (0.59 in) is only available in size 228.6 mm (9.00 in) and wider.

## Accessories

### Flight

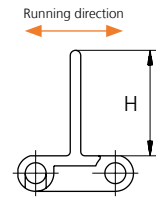
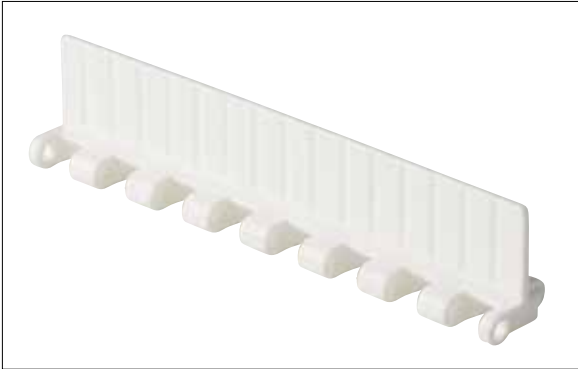

Type	Flight Material & color		H		Link size	Width		Indent	
			mm	in		mm	in	mm	in
Non Stick	PP-I	<b>W</b>	25.4	1.00	K300	76.4	3.01	0.0	0.00
	PP-I	<b>W</b> <b>G</b>							
Non Stick	PA6	<b>K</b>	25.4	1.00	K600	152.8	6.02	0.0	0.00
	04	<b>K</b>							
Non Stick	PP-I	<b>W</b> <b>G</b>	25.4	1.00	K600	152.8	6.02	15.0	0.59
Non Stick/Support Ribs	PP-I	<b>W</b>	25.4	1.00	K600	152.8	6.02	0.0	0.00
Non Stick/Support Ribs	PP-I	<b>W</b> <b>G</b>	50.8	2.00	K600	152.8	6.02	0.0	0.00
	PA6	<b>K</b>							
Non Stick/Support Ribs	PP-I	<b>G</b>	50.8	2.00	K600	152.8	6.02	15.0	0.59
	PA6	<b>K</b>							
Non Stick/Support Ribs	PP-I	<b>W</b> <b>G</b>	76.2	3.00	K600	152.8	6.02	0.0	0.00
Non Stick/Support Ribs	04	<b>K</b>	76.2	3.00	K600	152.8	6.02	0.0	0.00
Non Stick/Support Ribs	PP-I	<b>W</b> <b>G</b>	76.2	3.00	K600	152.8	6.02	15.0	0.59

Other Non Standard material and color: See uni Material and Color Overview.

## Accessories

### Side Guard

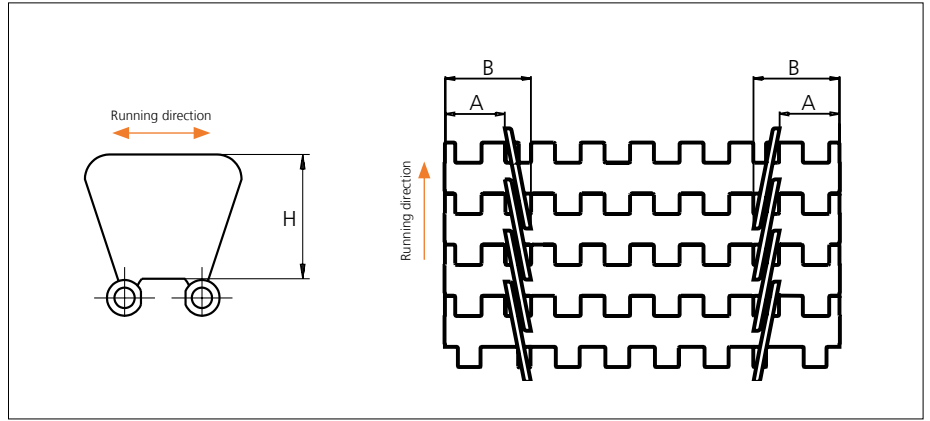

Type	Side Guard Material & color	H		A		B	
		mm	in	mm	in	mm	in
Closed	PP-I <b>W</b> <b>G</b>	31.4	1.24	15.0	0.59	25.0	0.98

Non Standard material and color: See uni Material and Color Overview.

## Accessories

### Tab

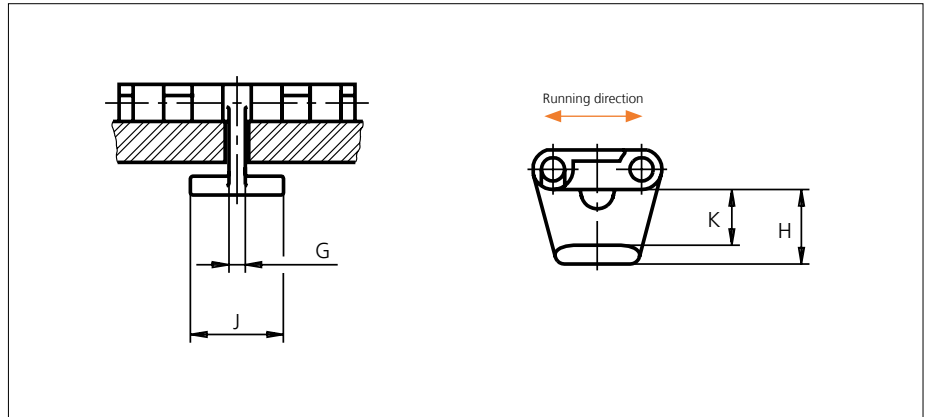

Type	Tab Material & color	G		J		K		H	
		mm	in	mm	in	mm	in	mm	in
Bottom Hold Down	POM-D <b>N</b>	3.5	0.14	20.0	0.79	11.7	0.46	15.9	0.63

Non Standard material and color: See uni Material and Color Overview.

## Sprocket

No of teeth	Bore size													Overall diameter		Pitch-diameter		Hub-diameter		A-dimension		B-dimension		Single row/Two way	Double row/Two way	Molded PA6 LG	Machined PA6 N
	Pilot bore		in	0.75	0.78	0.98	1.00	1.18	1.25	1.50	1.57	2.36	2.50														
	mm	19.1	20.0	25.0	25.4	30.0	31.8	38.1	40.0	60.0	63.5	90.0	mm	in	mm	in	mm	in	mm	in							
Z07	x	●	●										42.6	1.68	43.9	1.73	30.0	1.18	15.4	0.61	26.3	1.04	x		x		
Z10	x				●	●							61.7	2.43	61.6	2.43	45.0	1.77	25.0	0.98	35.2	1.39	x		x		
Z17	x			●	●	●	●	■	■				105.0	4.13	103.7	4.08	65.0	2.56	46.6	1.83	56.2	2.21	x		x		
Z24	x				●	●	●	■	■	●			147.2	5.80	146.0	5.75	70.0	2.76	68.0	2.68	77.3	3.04	x		x		
Z25	x					●	●	●	■	■			153.3	6.04	152.0	5.98	70.0	2.76	71.0	2.80	80.3	3.16	x		x		

■ Molded sprocket

● Molded sprocket

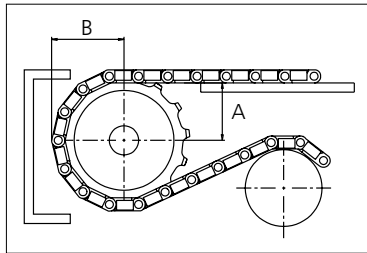
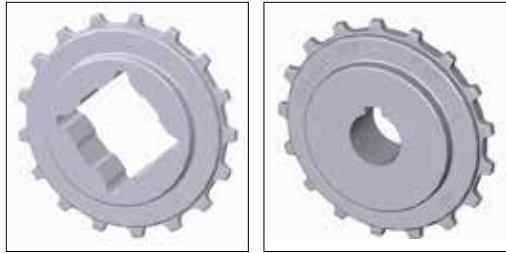

Other sprocket sizes are available upon request.  
 Two-part sprocket are available upon request.  
 Round bores are always delivered with keyway.  
 Other bore sizes are available upon request.  
 uni Retainer Rings: See uni Retainer Ring data sheet.  
 Width of tooth = 4.8 mm (0.19 in)  
 Width of sprocket = 25.0 mm (0.98 in)

Max load per sprocket shown does not take bore size into account.  
 Please also ensure that sufficient size shaft is chosen for corresponding load.

For correct sprocket position: See uni Assembly Instructions for uni Light.  
 For more detailed sprocket information, contact Customer Service.

Non standard material and color: See uni Material and Color Overview.



Expert advice, quality solutions and local service for all your belting needs  
[www.ammeraalbeltech.com](http://www.ammeraalbeltech.com)

**Ammeraal Beltech Modular A/S**  
 Hjulmagervej 21  
 DK-7100 Vejle

T +45 7572 3100  
 F +45 7572 3348  
 admin@unichains.com  
 www.unichains.com

This information is subject to alteration due to continuous development. Ammeraal Beltech will not be held liable for the incorrect use of the above stated information. This information replaces previous information. All activities performed and services rendered by Ammeraal Beltech are subject to general terms and conditions of sale and delivery, as applied by its operating companies.



# Plastic Modular Belt

Series **uni Light** Type **10%**

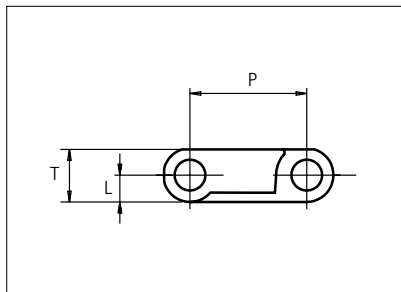

Straight running belt  
 Nominal pitch: 19.1 mm (0.75 in)  
 Surface type: Flat  
 Surface opening: 10%  
 Backflex radius: 25.0 mm (2.0 in)  
 Pin diameter: 5.0 mm (0.20 in)

<b>Belt material &amp; color</b>	POM-LF <b>BR</b>	<b>mm</b>	<b>in</b>	<b>mm</b>	<b>in</b>
<b>Pin material &amp; color</b>	PP <b>W</b>	<b>P (Nominal)</b>	19.1	0.75	<b>T</b>
		<b>L</b>	4.3	0.17	-
					8.5
					0.33

Non standard material and color: See uni Material and Color Overview.

Alternative pin and lock materials: Pin: PE **W** PP **W** PA6.6 **N** **B** PBT **LG** SS304 **W** Lockpin: PBT **LG** PA6.6 **D** **N** PP **W** **B**

Belt width		Permissible tensile force (Belt/pin material)		Belt weight (Belt/pin material)		*Min. No. drive sprocket per shaft	Number of wear strips (Min. No.)	
		POM-LF/PP		POM-LF/PP			**Carry (pcs)	**Return (pcs)
mm	in	N	lbf	kg/m	lb/ft			
77	3.0	789	177	0.5	0.32	2	2	2
115	4.5	1175	264	0.7	0.48	2	2	2
153	6.0	1572	353	1.0	0.64	2	2	2
230	9.0	2355	529	1.4	0.96	2	2	2
306	12.1	3138	705	1.9	1.28	3	3	2
383	15.1	3921	881	2.4	1.59	3	3	2
459	18.1	4704	1057	2.8	1.91	4	4	2
535	21.1	5486	1233	3.3	2.23	4	4	2
612	24.1	6269	1409	3.8	2.55	5	5	3
688	27.1	7052	1585	4.3	2.87	5	5	3
764	30.1	7835	1761	4.7	3.19	6	6	3
841	33.1	8618	1937	5.2	3.50	6	6	3
917	36.1	9401	2113	5.7	3.82	7	7	4

Additional standard belt widths are available in steps of 76.4 mm (3.01 in). Additional non-standard belt widths are available in steps of 19.1 mm (0.75 in).

1910	75.2	19578	4401	11.8	7.96	13	13	7
------	------	-------	------	------	------	----	----	---

Additional standard belt widths are available in steps of 76.4 mm (3.01 in). Additional non-standard belt widths are available in steps of 19.1 mm (0.75 in).

2980	117.3	30545	6867	18.5	12.42	20	20	10
------	-------	-------	------	------	-------	----	----	----

General belt tolerance is +0/-0.4% at 23°C/73°F and 50% RH. For exact belt width contact Customer Service. Non standard belt width on request.

\*Max. Load per Drive Sprocket. Belt material: POM-LF 1250 N

\*\*Max. Spacing between wear strips, Carry: 152.0 mm (6.00 in); Return: 304.0 mm (12.00 in).

= Single Link



STANDARD

STRAIGHT RUNNING

PITCH 19.1 MM/0.75 IN

## Accessories

### Rubber Top

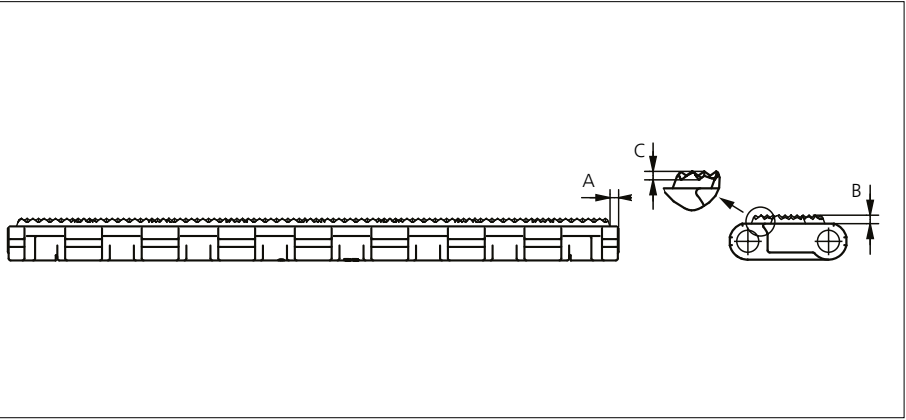

Type	Belt Material & color	Rubber Material & color	A		B		C		Link size	Width	
			mm	in	mm	in	mm	in		mm	in
NON STANDARD Flat	PP <b>K</b>	03 <b>K</b>	2.0	0.08	2.0	0.08	-	-	K300	76.0	2.99
STANDARD Rough							1.0	0.04	K450	114.0	4.49
									K600	150.5	5.93

Indent 15.0 mm (0.59 in) is only available in size 228.6 mm (9.00 in) and wider.

## Accessories

### Flight

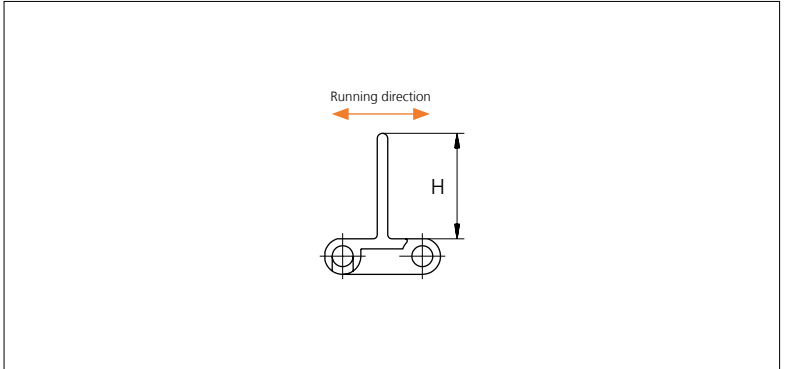
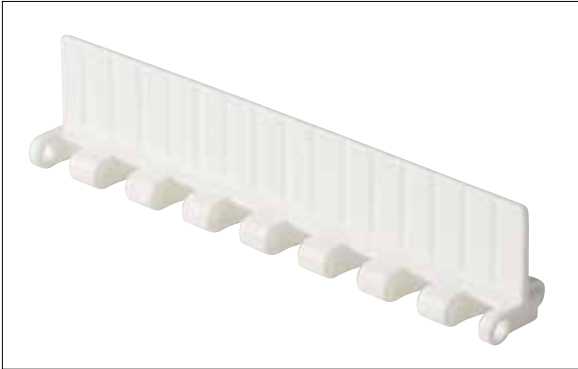

Type	Flight Material & color		H		Link size	Width		Indent	
			mm	in		mm	in	mm	in
Non Stick	PP-I	<b>W</b>	25.4	1.00	K300	76.4	3.01	0.0	0.00
	PP-I	<b>W</b> <b>G</b>							
Non Stick	PA6	<b>K</b>	25.4	1.00	K600	152.8	6.02	0.0	0.00
	04	<b>K</b>							
Non Stick	PP-I	<b>W</b> <b>G</b>	25.4	1.00	K600	152.8	6.02	15.0	0.59
Non Stick/Support Ribs	PP-I	<b>W</b>	25.4	1.00	K600	152.8	6.02	0.0	0.00
Non Stick/Support Ribs	PP-I	<b>W</b> <b>G</b>	50.8	2.00	K600	152.8	6.02	0.0	0.00
	PA6	<b>K</b>							
Non Stick/Support Ribs	PP-I	<b>G</b>	50.8	2.00	K600	152.8	6.02	15.0	0.59
	PA6	<b>K</b>							
Non Stick/Support Ribs	PP-I	<b>W</b> <b>G</b>	76.2	3.00	K600	152.8	6.02	0.0	0.00
Non Stick/Support Ribs	04	<b>K</b>	76.2	3.00	K600	152.8	6.02	0.0	0.00
Non Stick/Support Ribs	PP-I	<b>W</b> <b>G</b>	76.2	3.00	K600	152.8	6.02	15.0	0.59

Other Non Standard material and color: See uni Material and Color Overview.

## Accessories

### Side Guard

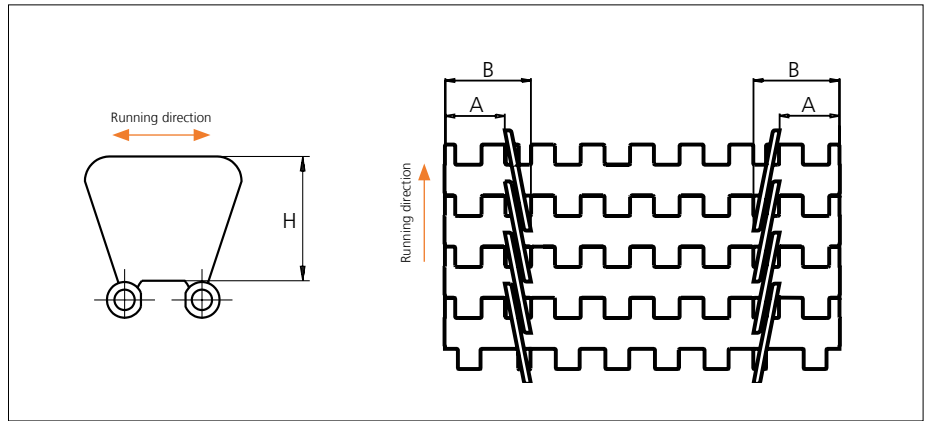

Type	Side Guard Material & color	H		A		B	
		mm	in	mm	in	mm	in
Closed	PP-I <b>W</b> <b>G</b>	31.4	1.24	15.0	0.59	25.0	0.98

Non Standard material and color: See uni Material and Color Overview.

## Accessories

### Tab

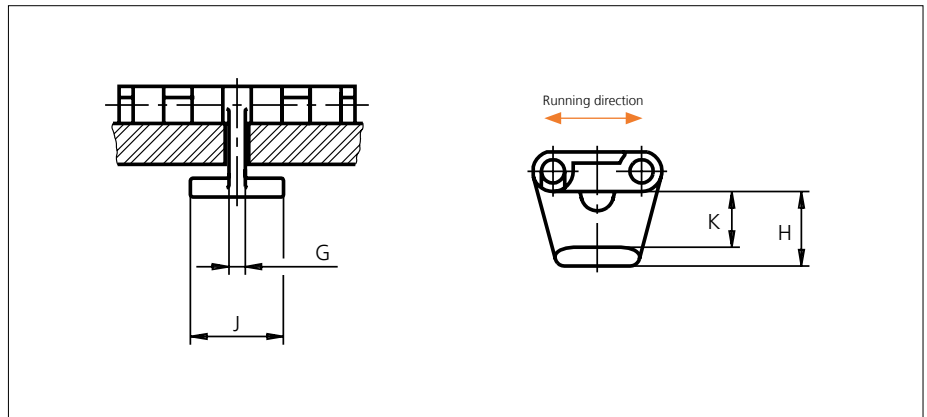

Type	Tab Material & color	G		J		K		H	
		mm	in	mm	in	mm	in	mm	in
Bottom Hold Down	POM-D <b>N</b>	3.5	0.14	20.0	0.79	11.7	0.46	15.9	0.63

Non Standard material and color: See uni Material and Color Overview.

## Sprocket

No of teeth	Bore size													Overall diameter		Pitch diameter		Hub diameter		A-dimension		B-dimension		Single row/Two way	Double row/Two way	Molded PA6 LG	Machined PA6 N
	Pilot bore	in	0.75	0.78	0.98	1.00	1.18	1.25	1.50	1.57	2.36	2.50	3.54														
	mm	19.1	20.0	25.0	25.4	30.0	31.8	38.1	40.0	60.0	63.5	90.0	mm	in	mm	in	mm	in	mm	in							
Z07	x	●	●										42.6	1.68	43.9	1.73	30.0	1.18	15.4	0.61	26.3	1.04	x		x		
Z10	x				●	●							61.7	2.43	61.6	2.43	45.0	1.77	25.0	0.98	35.2	1.39	x		x		
Z17	x			●	●	●	●	■	■				105.0	4.13	103.7	4.08	65.0	2.56	46.6	1.83	56.2	2.21	x		x		
Z24	x				●	●	●	■	■	●			147.2	5.80	146.0	5.75	70.0	2.76	68.0	2.68	77.3	3.04	x		x		
Z25	x					●	●	●	●	■	■		153.3	6.04	152.0	5.98	70.0	2.76	71.0	2.80	80.3	3.16	x		x		

■ Molded sprocket

● Molded sprocket

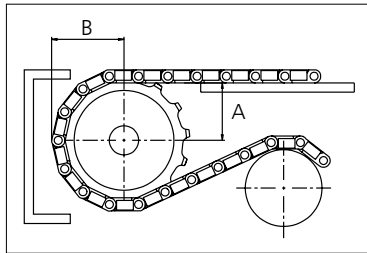
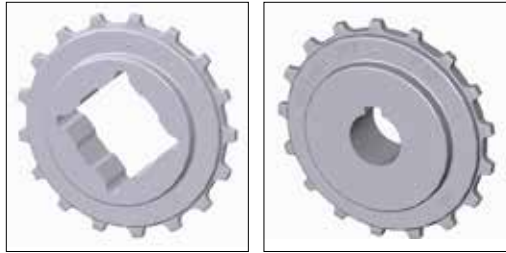

Other sprocket sizes are available upon request.  
 Two-part sprocket are available upon request.  
 Round bores are always delivered with keyway.  
 Other bore sizes are available upon request.  
 uni Retainer Rings: See uni Retainer Ring data sheet.  
 Width of tooth = 4.8 mm (0.19 in)  
 Width of sprocket = 25.0 mm (0.98 in)

Max load per sprocket shown does not take bore size into account.  
 Please also ensure that sufficient size shaft is chosen for corresponding load.

For correct sprocket position: See uni Assembly Instructions for uni Light.  
 For more detailed sprocket information, contact Customer Service.

Non standard material and color: See uni Material and Color Overview.



Expert advice, quality solutions and local service for all your belting needs  
[www.ammeraalbeltech.com](http://www.ammeraalbeltech.com)

**Ammeraal Beltech Modular A/S**  
 Hjulmagervej 21  
 DK-7100 Vejle

T +45 7572 3100  
 F +45 7572 3348  
 admin@unichains.com  
 www.unichains.com

This information is subject to alteration due to continuous development. Ammeraal Beltech will not be held liable for the incorrect use of the above stated information. This information replaces previous information. All activities performed and services rendered by Ammeraal Beltech are subject to general terms and conditions of sale and delivery, as applied by its operating companies.





# Plastic Modular Belt

Series **uni Light** Type **22%**

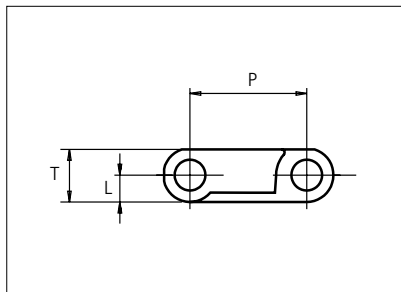

Straight running belt  
 Nominal pitch: 19.1 mm (0.75 in)  
 Surface type: Flat  
 Surface opening: 22%  
 Backflex radius: 25.0 mm (2.0 in)  
 Pin diameter: 5.0 mm (0.20 in)

<b>Belt material &amp; color</b>	POM-LF <b>BR</b>	PP <b>G</b>	<b>mm</b>	<b>in</b>	<b>mm</b>	<b>in</b>		
<b>Pin material &amp; color</b>	PP <b>W</b>		<b>P (Nominal)</b>	19.1	0.75	<b>T</b>	8.5	0.33
			<b>L</b>	4.3	0.17	-	-	-

Non standard material and color: See uni Material and Color Overview.

Alternative pin and lock materials: Pin: PE **W** PP **W** PA6.6 **N** **B** PBT **LG** SS304 **W** Lockpin: PBT **LG** PA6.6 **D** **N** PP **W** **B**

Belt width		Permissible tensile force (Belt/pin material)				Belt weight (Belt/pin material)				*Min. No. drive sprocket per shaft	Number of wear strips (Min. No.)	
		POM-LF/PP		PP/PP		POM-LF/PP		PP/PP			**Carry (pcs)	**Return (pcs)
mm	in	N	lbf	N	lbf	kg/m	lb/ft	kg/m	lb/ft			
77	3.0	789	177	395	89	0.4	0.29	0.3	0.21	2	2	2
115	4.5	1175	264	587	132	0.6	0.43	0.5	0.31	2	2	2
153	6.0	1572	353	786	177	0.9	0.58	0.6	0.41	2	2	2
230	9.0	2355	529	1177	265	1.3	0.86	0.9	0.62	2	2	2
306	12.1	3138	705	1569	353	1.7	1.15	1.2	0.82	3	3	2
383	15.1	3921	881	1960	441	2.1	1.44	1.5	1.03	3	3	2
459	18.1	4704	1057	2352	529	2.6	1.73	1.8	1.23	4	4	2
535	21.1	5486	1233	2743	617	3.0	2.01	2.1	1.44	4	4	2
612	24.1	6269	1409	3135	705	3.4	2.30	2.4	1.64	5	5	3
688	27.1	7052	1585	3526	793	3.9	2.59	2.8	1.85	5	5	3
764	30.1	7835	1761	3918	881	4.3	2.88	3.1	2.05	6	6	3
841	33.1	8618	1937	4309	969	4.7	3.16	3.4	2.26	6	6	3
917	36.1	9401	2113	4700	1057	5.1	3.45	3.7	2.47	7	7	4

Additional standard belt widths are available in steps of 76.4 mm (3.01 in). Additional non-standard belt widths are available in steps of 19.1 mm (0.75 in).

1910	75.2	19578	4401	9789	2201	10.7	7.19	7.6	5.13	13	13	7
------	------	-------	------	------	------	------	------	-----	------	----	----	---

Additional standard belt widths are available in steps of 76.4 mm (3.01 in). Additional non-standard belt widths are available in steps of 19.1 mm (0.75 in).

2980	117.3	30545	6867	15273	3433	16.7	11.22	11.9	8.01	20	20	10
------	-------	-------	------	-------	------	------	-------	------	------	----	----	----

General belt tolerance is +0/-0.4% at 23°C/73°F and 50% RH. For exact belt width contact Customer Service. Non standard belt width on request.

\*Max. Load per Drive Sprocket. Belt material: POM-LF 1250 N (281 lbf), PP 700 N (157 lbf)

\*\*Max. Spacing between wear strips, Carry: 152.0 mm (6.00 in); Return: 304.0 mm (12.00 in)

= Single Link



STANDARD

STRAIGHT RUNNING

PITCH 19.1 MM/0.75 IN

## Accessories

### Rubber Top

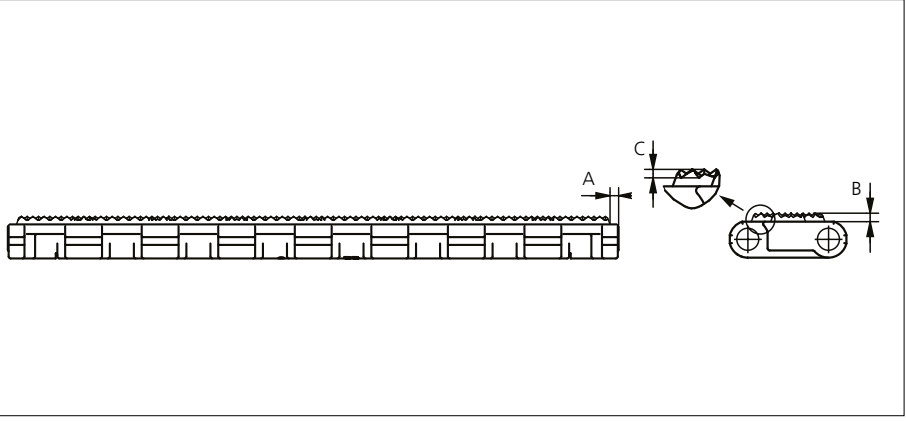

Type	Belt Material & color	Rubber Material & color	A		B		C		Link size	Width	
			mm	in	mm	in	mm	in		mm	in
NON STANDARD Flat	PP <b>K</b>	03 <b>K</b>	2.0	0.08	2.0	0.08	-	-	K300	76.0	2.99
STANDARD Rough							1.0	0.04	K450	114.0	4.49
									K600	150.5	5.93

Indent 15.0 mm (0.59 in) is only available in size 228.6 mm (9.00 in) and wider.

## Accessories

### Flight

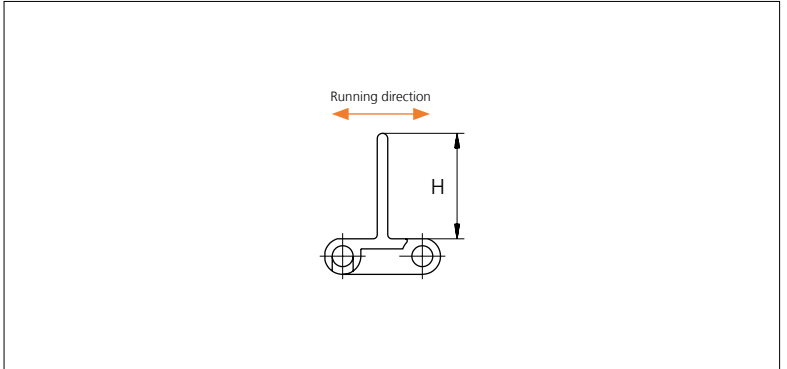
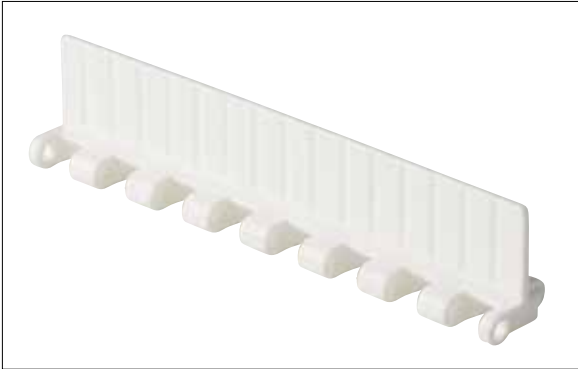

Type	Flight Material & color		H		Link size	Width		Indent	
			mm	in		mm	in	mm	in
Non Stick	PP-I	<b>W</b>	25.4	1.00	K300	76.4	3.01	0.0	0.00
	PP-I PA6 04	<b>W</b> <b>G</b> <b>K</b> <b>K</b>			K600	152.8	6.02	0.0	0.00
Non Stick	PP-I PA6	<b>W</b> <b>G</b> <b>K</b>	25.4	1.00	K600	152.8	6.02	15.0	0.59
Non Stick/Support Ribs	PP-I	<b>W</b>	25.4	1.00	K600	152.8	6.02	0.0	0.00
Non Stick/Support Ribs	PP-I PA6	<b>W</b> <b>G</b> <b>K</b>	50.8	2.00	K600	152.8	6.02	0.0	0.00
Non Stick/Support Ribs	PP-I PA6	<b>G</b> <b>K</b>	50.8	2.00	K600	152.8	6.02	15.0	0.59
Non Stick/Support Ribs	PP-I 04	<b>W</b> <b>G</b> <b>K</b>	76.2	3.00	K600	152.8	6.02	0.0	0.00
Non Stick/Support Ribs	PP-I	<b>W</b> <b>G</b>	76.2	3.00	K600	152.8	6.02	15.0	0.59

Other Non Standard material and color: See uni Material and Color Overview.

## Accessories

### Side Guard

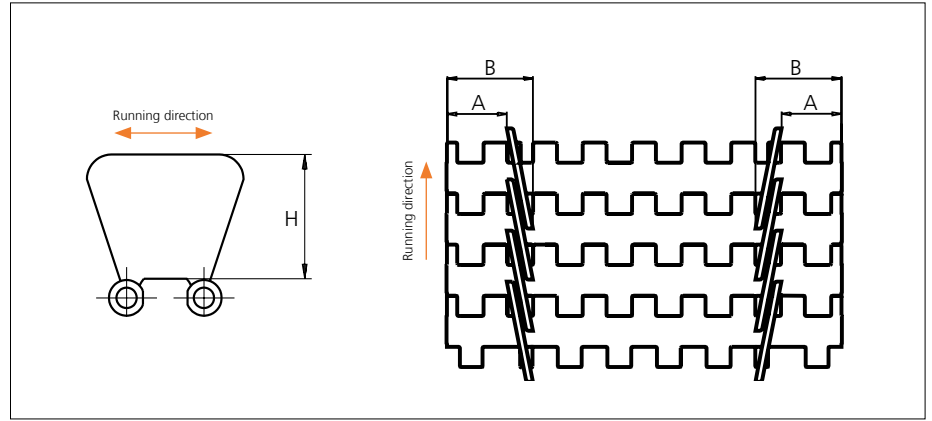

Type	Side Guard Material & color	H		A		B	
		mm	in	mm	in	mm	in
Closed	PP-I <b>W</b> <b>G</b>	31.4	1.24	15.0	0.59	25.0	0.98

Non Standard material and color: See uni Material and Color Overview.

## Accessories

### Tab

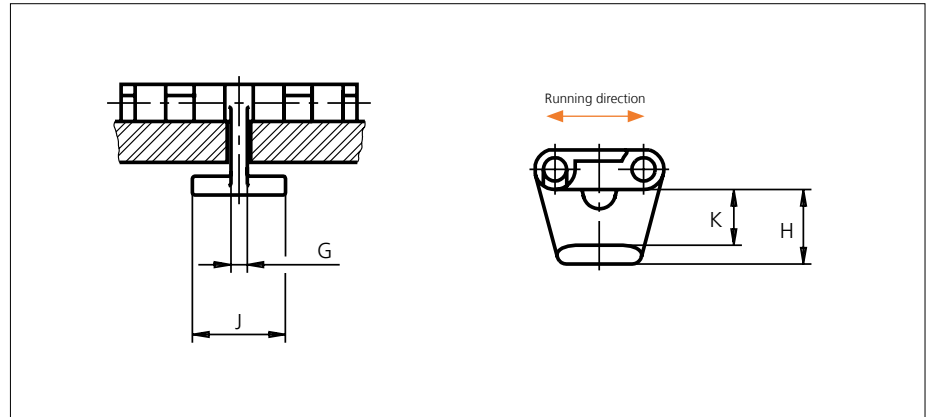

Type	Tab Material & color	G		J		K		H	
		mm	in	mm	in	mm	in	mm	in
Bottom Hold Down	POM-D <b>N</b>	3.5	0.14	20.0	0.79	11.7	0.46	15.9	0.63

Non Standard material and color: See uni Material and Color Overview.

## Sprocket

No of teeth	Bore size													Overall diameter		Pitch-diameter		Hub-diameter		A-dimension		B-dimension		Single row/Two way	Double row/Two way	Molded PA6 LG	Machined PA6 N
	Pilot bore		in	0.75	0.78	0.98	1.00	1.18	1.25	1.50	1.57	2.36	2.50														
	mm	19.1	20.0	25.0	25.4	30.0	31.8	38.1	40.0	60.0	63.5	90.0	mm	in	mm	in	mm	in	mm	in							
Z07	x	●	●									42.6	1.68	43.9	1.73	30.0	1.18	15.4	0.61	26.3	1.04	x		x			
Z10	x				●	●						61.7	2.43	61.6	2.43	45.0	1.77	25.0	0.98	35.2	1.39	x		x			
Z17	x			●	●	●	●	■	■			105.0	4.13	103.7	4.08	65.0	2.56	46.6	1.83	56.2	2.21	x		x			
Z24	x				●	●	●	■	■	●		147.2	5.80	146.0	5.75	70.0	2.76	68.0	2.68	77.3	3.04	x		x			
Z25	x					●	●	●	●	■	■	153.3	6.04	152.0	5.98	70.0	2.76	71.0	2.80	80.3	3.16	x		x			

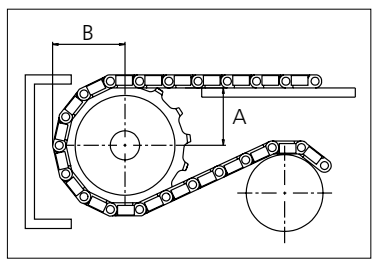
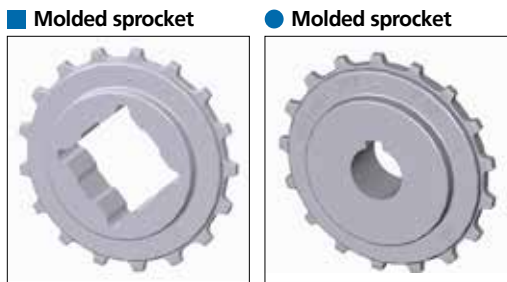

Other sprocket sizes are available upon request.  
 Two-part sprocket are available upon request.  
 Round bores are always delivered with keyway.  
 Other bore sizes are available upon request.  
 uni Retainer Rings: See uni Retainer Ring data sheet.  
 Width of tooth = 4.8 mm (0.19 in)  
 Width of sprocket = 25.0 mm (0.98 in)

Max load per sprocket shown does not take bore size into account.  
 Please also ensure that sufficient size shaft is chosen for corresponding load.

For correct sprocket position: See uni Assembly Instructions for uni Light.  
 For more detailed sprocket information, contact Customer Service.

Non standard material and color: See uni Material and Color Overview.



Expert advice, quality solutions and local service for all your belting needs  
[www.ammeraalbeltech.com](http://www.ammeraalbeltech.com)

**Ammeraal Beltech Modular A/S**  
 Hjulmagervej 21  
 DK-7100 Vejle

T +45 7572 3100  
 F +45 7572 3348  
 admin@unichains.com  
 www.unichains.com

This information is subject to alteration due to continuous development. Ammeraal Beltech will not be held liable for the incorrect use of the above stated information. This information replaces previous information. All activities performed and services rendered by Ammeraal Beltech are subject to general terms and conditions of sale and delivery, as applied by its operating companies.



# Plastic Modular Belt

Series **uni Light** Type **Rough**

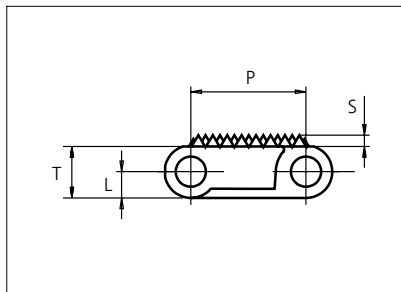

Straight running belt  
 Nominal pitch: 19.1 mm (0.75 in)  
 Surface type: Rough Top  
 Surface opening: Closed  
 Backflex radius: 25.0 mm (1.0 in)  
 Pin diameter: 5.0 mm (0.20 in)

Recommended Belt material & color	POM-D <b>W</b>	mm	in		mm	in	
		P (Nominal)	19.1	0.75	T	8.5	0.33
Recommended Pin material & color	PA6.6 <b>N</b>	L	4.3	0.17	S	1.5	0.06

Non standard material and color: See uni Material and Color Overview.

Alternative pin and lock materials: Pin: PE **W** PP **W** PA6.6 **N** **B** PBT **LG** SS304 **W** Lockpin: PBT **LG** PA6.6 **D** **N** PP **W** **B**

Belt width		Permissible tensile force (Belt/pin material)						Belt weight (Belt/pin material)						*Min. No. drive sprocket per shaft	Number of wear strips (Min. No.)	
		POM-LF/PA6.6		PP/PA6.6		PA6/PBT-GR		POM-LF/PA6.6		PP/PA6.6		PA6/PBT-GR			**Carry (pcs)	**Return (pcs)
mm	in	N	lbf	N	lbf	N	lbf	kg/m	lb/ft	kg/m	lb/ft	kg/m	lb/ft			
77	3.0	789	177	395	89	789	177	0.5	0.35	0.4	0.25	0.4	0.29	2	2	2
153	6.0	1572	353	786	177	1572	353	1.0	0.70	0.7	0.49	0.9	0.58	2	2	2
230	9.0	2355	529	1177	265	2355	529	1.6	1.05	1.1	0.74	1.3	0.86	2	2	2
306	12.1	3138	705	1569	353	3138	705	2.1	1.40	1.5	0.99	1.7	1.15	3	3	2
383	15.1	3921	881	1960	441	3921	881	2.6	1.75	1.8	1.23	2.1	1.44	3	3	2
459	18.1	4704	1057	2352	529	4704	1057	3.1	2.10	2.2	1.48	2.6	1.73	4	4	2
535	21.1	5486	1233	2743	617	5486	1233	3.6	2.45	2.6	1.73	3.0	2.01	4	4	2
612	24.1	6269	1409	3135	705	6269	1409	4.2	2.80	2.9	1.97	3.4	2.30	5	5	3
688	27.1	7052	1585	3526	793	7052	1585	4.7	3.14	3.3	2.22	3.9	2.59	5	5	3
764	30.1	7835	1761	3918	881	7835	1761	5.2	3.49	3.7	2.47	4.3	2.88	6	6	3
841	33.1	8618	1937	4309	969	8618	1937	5.7	3.84	4.0	2.71	4.7	3.16	6	6	3
917	36.1	9401	2113	4700	1057	9401	2113	6.2	4.19	4.4	2.96	5.1	3.45	7	7	4
994	39.1	10184	2289	5092	1145	10184	2289	6.8	4.54	4.8	3.20	5.6	3.74	7	7	4

Additional standard belt widths are available in steps of 76.4 mm (3.01 in). Additional non-standard belt widths are available in steps of 19.1 mm (0.75 in).

1910	75.2	19578	4401	9789	2201	19578	4401	13.0	8.73	9.2	6.16	10.7	7.19	13	13	7
------	------	-------	------	------	------	-------	------	------	------	-----	------	------	------	----	----	---

Additional standard belt widths are available in steps of 76.4 mm (3.01 in). Additional non-standard belt widths are available in steps of 19.1 mm (0.75 in).

2980	117.3	30545	6867	15273	3433	30545	6867	20.3	13.62	14.3	9.61	16.7	11.22	20	20	10
------	-------	-------	------	-------	------	-------	------	------	-------	------	------	------	-------	----	----	----

General belt tolerance is +0/-0.4% at 23°C/73°F and 50% RH. For exact belt width contact Customer Service. Non standard belt width on request.

\*Max. Load per Drive Sprocket. Belt material: POM-LF 1250 N (281 lbf), PP 700 N (157 lbf), PA6 1250 N (281 lbf)

\*\*Max. Spacing between wear strips, Carry: 152.0 mm (6.00 in); Return: 304.0 mm (12.00 in)

= Single Link



NON STANDARD

STRAIGHT RUNNING

PITCH 19.1 MM/0.75 IN

## Accessories

### Rubber Top

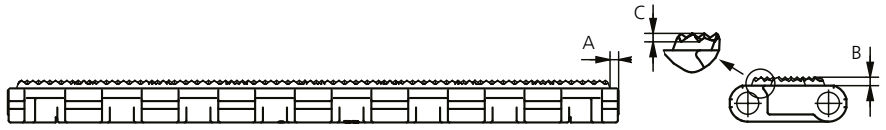

Type	Belt Material & color	Rubber Material & color	A		B		C		Link size	Width	
			mm	in	mm	in	mm	in		mm	in
NON STANDARD Flat	PP <b>K</b>	03 <b>K</b>	2.0	0.08	2.0	0.08	-	-	K300	76.0	2.99
STANDARD Rough							1.0	0.04		K450	114.0
							K600	150.5	5.93		

Indent 15.0 mm (0.59 in) is only available in size 228.6 mm (9.00 in) and wider.

## Accessories

### Flight

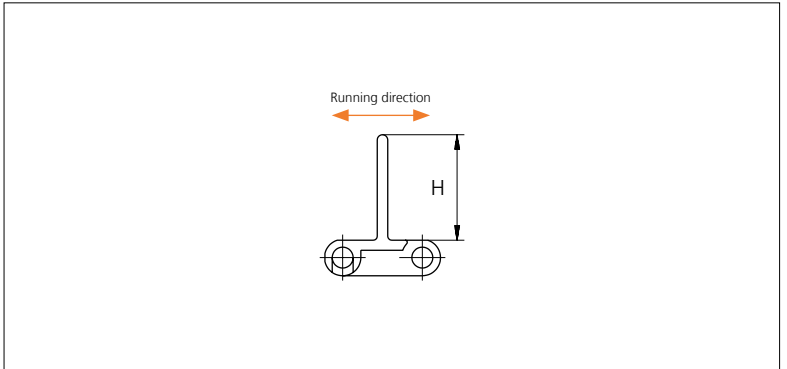
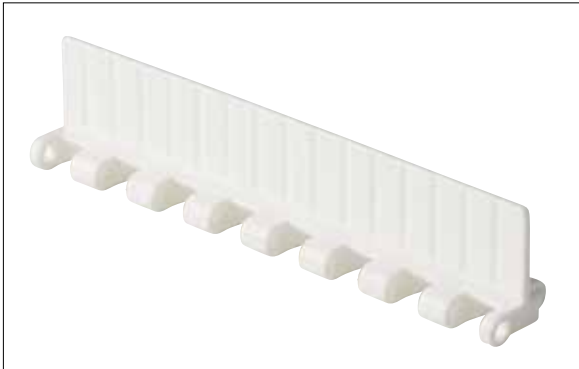

Type	Flight Material & color		H		Link size	Width		Indent	
			mm	in		mm	in	mm	in
Non Stick	PP-I	<b>W</b>	25.4	1.00	K300	76.4	3.01	0.0	0.00
	PP-I	<b>W</b> <b>G</b>							
	PA6	<b>K</b>			K600	152.8	6.02	0.0	0.00
04	<b>K</b>								
Non Stick	PP-I	<b>W</b> <b>G</b>	25.4	1.00	K600	152.8	6.02	15.0	0.59
Non Stick/Support Ribs	PP-I	<b>W</b>	25.4	1.00	K600	152.8	6.02	0.0	0.00
Non Stick/Support Ribs	PP-I	<b>W</b> <b>G</b>	50.8	2.00	K600	152.8	6.02	0.0	0.00
	PA6	<b>K</b>							
Non Stick/Support Ribs	PP-I	<b>G</b>	50.8	2.00	K600	152.8	6.02	15.0	0.59
	PA6	<b>K</b>							
Non Stick/Support Ribs	PP-I	<b>W</b> <b>G</b>	76.2	3.00	K600	152.8	6.02	0.0	0.00
Non Stick/Support Ribs	04	<b>K</b>	76.2	3.00	K600	152.8	6.02	15.0	0.59

Other Non Standard material and color: See uni Material and Color Overview.

## Accessories

### Side Guard

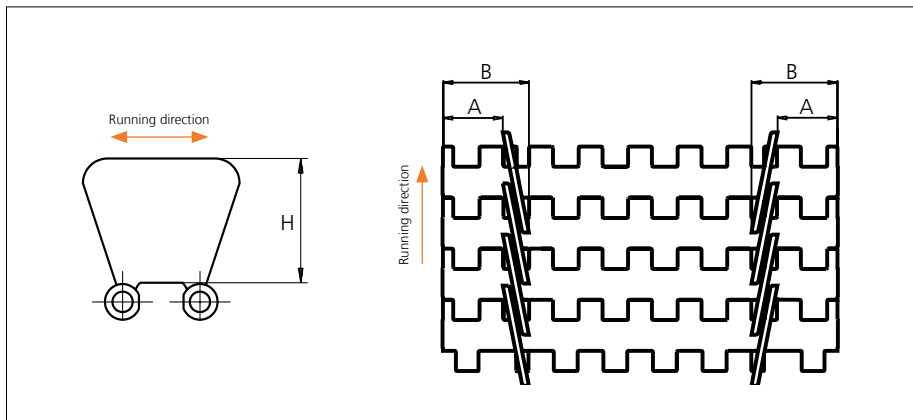

Type	Side Guard Material & color	H		A		B	
		mm	in	mm	in	mm	in
Closed	PP-I <b>W</b> <b>G</b>	31.4	1.24	15.0	0.59	25.0	0.98

Non Standard material and color: See uni Material and Color Overview.

## Accessories

### Tab

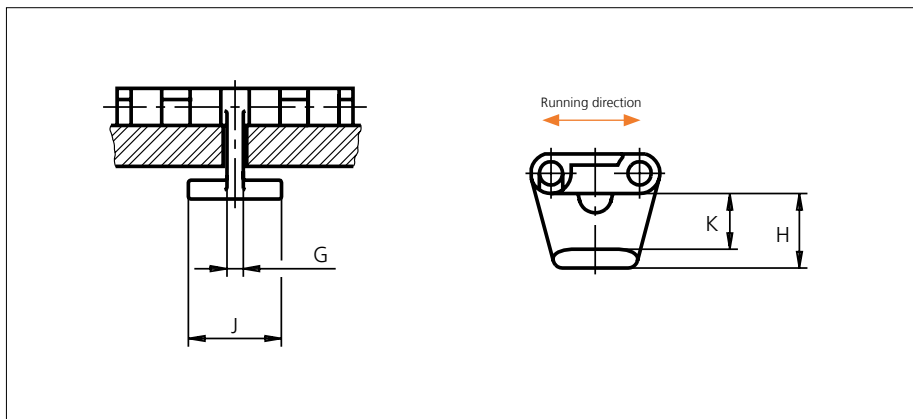

Type	Tab Material & color	G		J		K		H	
		mm	in	mm	in	mm	in	mm	in
Bottom Hold Down	POM-D <b>N</b>	3.5	0.14	20.0	0.79	11.7	0.46	15.9	0.63

Non Standard material and color: See uni Material and Color Overview.

## Sprocket

No. of teeth	Bore size													Overall diameter		Pitch-diameter		Hub-diameter		A-dimension		B-dimension		Single row/Two way	Double row/Two way	Molded PA6 LG	Machined PA6 N
	Pilot bore		0.75	0.78	0.98	1.00	1.18	1.25	1.50	1.57	2.36	2.50	3.54														
	mm	in	19.1	20.0	25.0	25.4	30.0	31.8	38.1	40.0	60.0	63.5	90.0	mm	in	mm	in	mm	in	mm	in	x	x	x	x		
Z07	x	●	●										42.6	1.68	43.9	1.73	30.0	1.18	15.4	0.61	26.3	1.04	x		x		
Z10	x				●	●							61.7	2.43	61.6	2.43	45.0	1.77	25.0	0.98	35.2	1.39	x		x		
Z17	x			●	●	●	●	■	■				105.0	4.13	103.7	4.08	65.0	2.56	46.6	1.83	56.2	2.21	x		x		
Z24	x				●	●	●	■	■	●			147.2	5.80	146.0	5.75	70.0	2.76	68.0	2.68	77.3	3.04	x		x		
Z25	x					●	●	●	●	■	■		153.3	6.04	152.0	5.98	70.0	2.76	71.0	2.80	80.3	3.16	x		x		

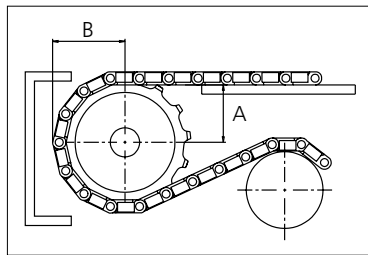
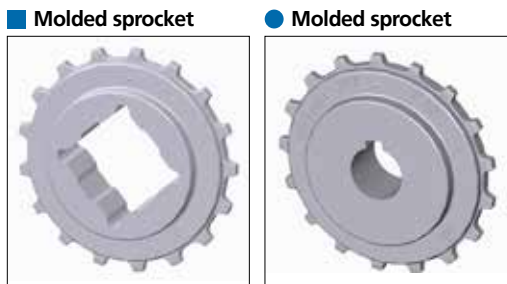

Other sprocket sizes are available upon request  
 Two-part sprocket are available upon request  
 Other bore sizes are available upon request  
 uni Retainer Rings: See uni Retainer Ring data sheet  
 Width of tooth = 4.8 mm (0.19 in)  
 Width of sprocket = 25.0 mm (0.98 in)

Max load per sprocket shown does not take bore size into account.  
 Please also ensure that sufficient size shaft is chosen for corresponding load.

For correct sprocket position: See uni Assembly Instructions for uni Light.  
 For more detailed sprocket information, contact Customer Service.

Non standard material and color: See uni Material and Color Overview.



Expert advice, quality solutions and local service for all your belting needs  
[www.ammeraalbeltech.com](http://www.ammeraalbeltech.com)

**Ammeraal Beltech Modular A/S**  
 Hjulmagervej 21  
 DK-7100 Vejle

T +45 7572 3100  
 F +45 7572 3348  
 admin@unichains.com  
 www.unichains.com

This information is subject to alteration due to continuous development. Ammeraal Beltech will not be held liable for the incorrect use of the above stated information. This information replaces previous information. All activities performed and services rendered by Ammeraal Beltech are subject to general terms and conditions of sale and delivery, as applied by its operating companies.





# Plastic Modular Belt

Series **uni Light** Type **10% SR**

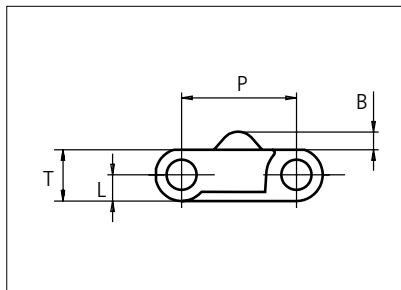

Straight running belt  
 Nominal pitch: 19.1 mm (0.75 in)  
 Surface type: Small Rib  
 Surface opening: Closed  
 Backflex radius: 25.0 mm (1.0 in)  
 Pin diameter: 5.0 mm (0.20 in)

<b>Recommended Belt material &amp; color</b>	POM-LF <b>BR</b>	<b>mm</b>	<b>in</b>	<b>mm</b>	<b>in</b>		
<b>Recommended Pin material &amp; color</b>	PA6.6 <b>N</b>	<b>P (Nominal)</b>	19.1	0.75	<b>T</b>	8.5	0.33
		<b>L</b>	4.3	0.17	<b>B</b>	3.0	0.12

Non standard material and color: See uni Material and Color Overview.

Alternative pin and lock materials: Pin: PE **W** PP **W** PA6.6 **N** **B** PBT **LG** SS304 PP **W** Lockpin: PBT **LG** PA6.6 **D** **N** PP **W** **B**

Belt width		Permissible tensile force (Belt/pin material)		Belt weight (Belt/pin material)		*Min. No. drive sprocket per shaft	Number of wear strips (Min. No.)	
		POM-SLF/PA6.6		POM-SLF/PA6.6			**Carry (pcs)	**Return (pcs)
mm	in	N	lbf	kg/m	lb/ft			
77	3.0	789	177	0.5	0.32	2	2	2
153	6.0	1572	353	1.0	0.64	2	2	2
230	9.0	2355	529	1.4	0.96	2	2	2
306	12.1	3138	705	1.9	1.28	3	3	2
383	15.1	3921	881	2.4	1.59	3	3	2
459	18.1	4704	1057	2.8	1.91	4	4	2
535	21.1	5486	1233	3.3	2.23	4	4	2
612	24.1	6269	1409	3.8	2.55	5	5	3
688	27.1	7052	1585	4.3	2.87	5	5	3
764	30.1	7835	1761	4.7	3.19	6	6	3
841	33.1	8618	1937	5.2	3.50	6	6	3
917	36.1	9401	2113	5.7	3.82	7	7	4
994	39.1	10184	2289	6.2	4.14	7	7	4

Additional standard belt widths are available in steps of 76.4 mm (3.01 in). Additional non-standard belt widths are available in steps of 19.1 mm (0.75 in).

1910	75.2	19578	4401	11.8	7.96	13	13	7
------	------	-------	------	------	------	----	----	---

Additional standard belt widths are available in steps of 76.4 mm (3.01 in). Additional non-standard belt widths are available in steps of 19.1 mm (0.75 in).

2980	117.3	30545	6867	18.5	12.42	20	20	10
------	-------	-------	------	------	-------	----	----	----

General belt tolerance is +0/-0.4% at 23°C/73°F and 50% RH. For exact belt width contact Customer Service. Non standard belt width on request.

\*Max. Load per Drive Sprocket. Belt material: POM-LF 1250 N

\*\*Max. Spacing between wear strips, Carry: 152.0 mm (6.00 in); Return: 304.0 mm (12.00 in)

= Single Link



NON STANDARD

STRAIGHT RUNNING

PITCH 19.1 MM/0.75 IN

## Accessories

### Rubber Top

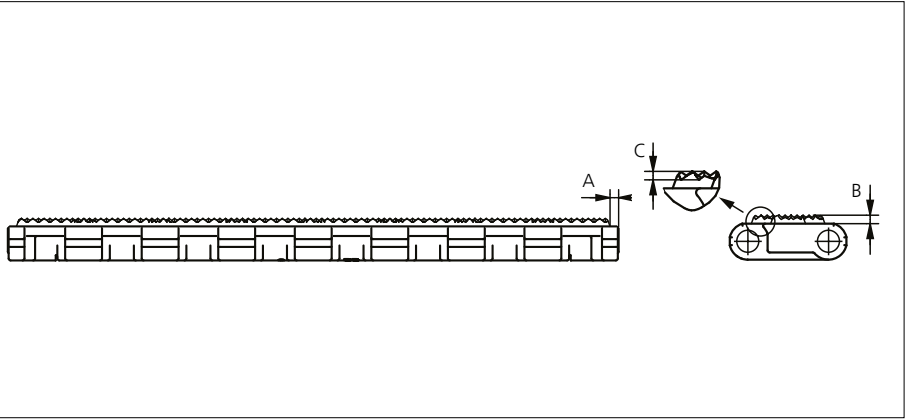

Type	Belt Material & color	Rubber Material & color	A		B		C		Link size	Width	
			mm	in	mm	in	mm	in		mm	in
NON STANDARD Flat	PP <b>K</b>	03 <b>K</b>	2.0	0.08	2.0	0.08	-	-	K300	76.0	2.99
STANDARD Rough							1.0	0.04		K450	114.0
							K600	150.5	5.93		

Indent 15.0 mm (0.59 in) is only available in size 228.6 mm (9.00 in) and wider.

## Accessories

### Flight

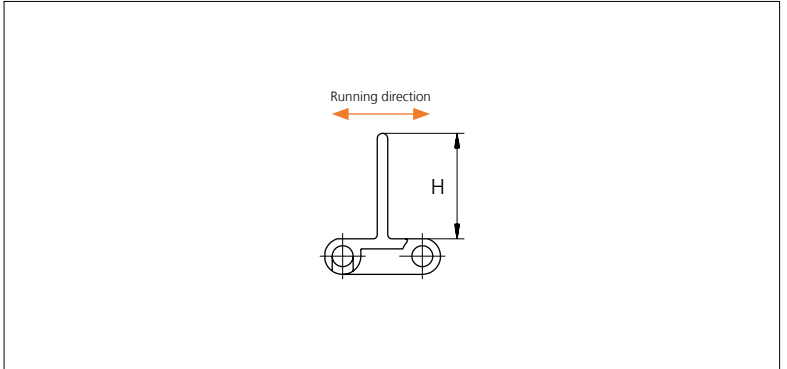
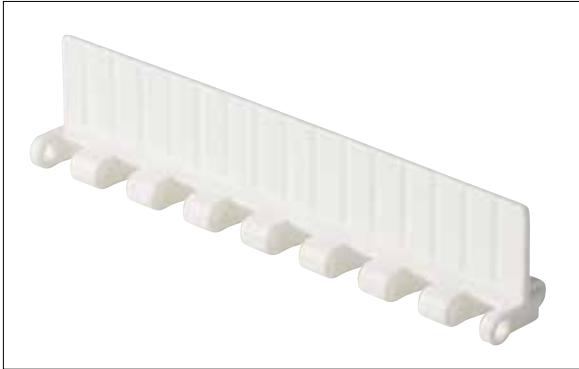

Type	Flight Material & color		H		Link size	Width		Indent	
			mm	in		mm	in	mm	in
Non Stick	PP-I	<b>W</b>	25.4	1.00	K300	76.4	3.01	0.0	0.00
	PP-I	<b>W</b> <b>G</b>							
Non Stick	PA6	<b>K</b>	25.4	1.00	K600	152.8	6.02	0.0	0.00
	04	<b>K</b>							
Non Stick	PP-I	<b>W</b> <b>G</b>	25.4	1.00	K600	152.8	6.02	15.0	0.59
Non Stick/Support Ribs	PP-I	<b>W</b>	25.4	1.00	K600	152.8	6.02	0.0	0.00
Non Stick/Support Ribs	PP-I	<b>W</b> <b>G</b>	50.8	2.00	K600	152.8	6.02	0.0	0.00
	PA6	<b>K</b>							
Non Stick/Support Ribs	PP-I	<b>G</b>	50.8	2.00	K600	152.8	6.02	15.0	0.59
	PA6	<b>K</b>							
Non Stick/Support Ribs	PP-I	<b>W</b> <b>G</b>	76.2	3.00	K600	152.8	6.02	0.0	0.00
Non Stick/Support Ribs	04	<b>K</b>	76.2	3.00	K600	152.8	6.02	0.0	0.00
Non Stick/Support Ribs	PP-I	<b>W</b> <b>G</b>	76.2	3.00	K600	152.8	6.02	15.0	0.59

Other Non Standard material and color: See uni Material and Color Overview.

## Accessories

### Side Guard

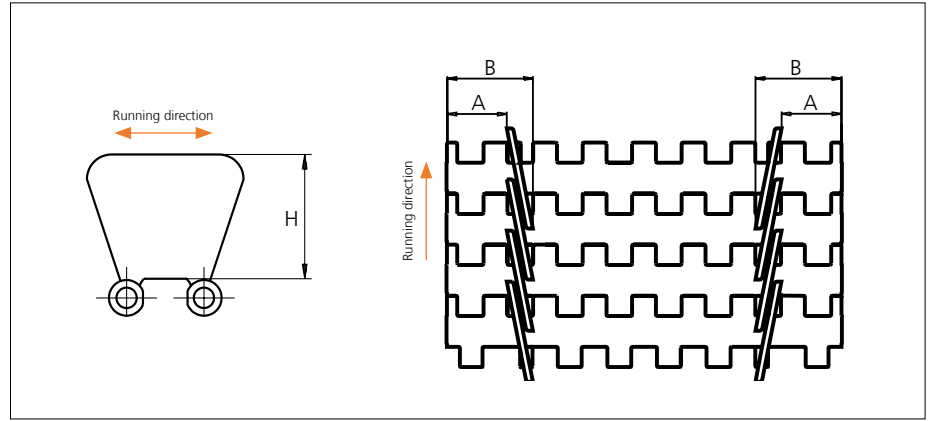

Type	Side Guard Material & color	H		A		B	
		mm	in	mm	in	mm	in
Closed	PP-I <b>W</b> <b>G</b>	31.4	1.24	15.0	0.59	25.0	0.98

Non Standard material and color: See uni Material and Color Overview.

## Accessories

### Tab

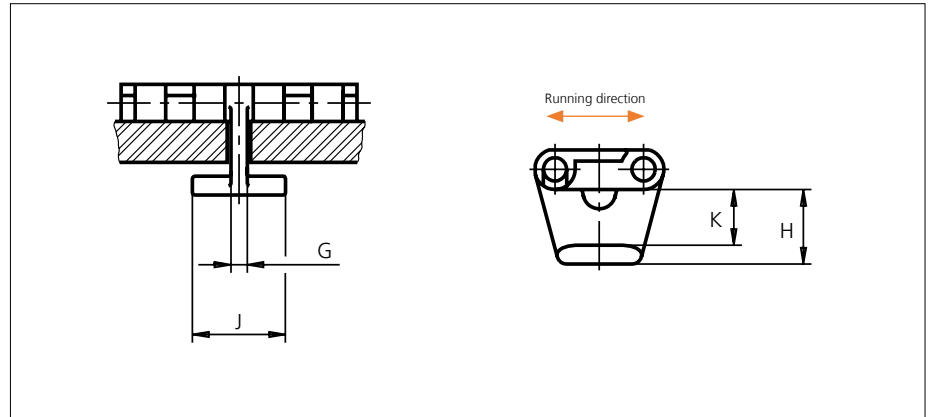

Type	Tab Material & color	G		J		K		H	
		mm	in	mm	in	mm	in	mm	in
Bottom Hold Down	POM-D <b>N</b>	3.5	0.14	20.0	0.79	11.7	0.46	15.9	0.63

Non Standard material and color: See uni Material and Color Overview.

## Sprocket

No of teeth	Bore size													Overall diameter		Pitch-diameter		Hub-diameter		A-dimension		B-dimension		Single row/Two way	Double row/Two way	Molded PA6 LG	Machined PA6 N
	Pilot bore	in	0.75	0.78	0.98	1.00	1.18	1.25	1.50	1.57	2.36	2.50	3.54														
	mm	19.1	20.0	25.0	25.4	30.0	31.8	38.1	40.0	60.0	63.5	90.0	mm	in	mm	in	mm	in	mm	in							
Z07	x	●	●										42.6	1.68	43.9	1.73	30.0	1.18	15.4	0.61	26.3	1.04	x		x		
Z10	x				●	●							61.7	2.43	61.6	2.43	45.0	1.77	25.0	0.98	35.2	1.39	x		x		
Z17	x			●	●	●	●	■	■				105.0	4.13	103.7	4.08	65.0	2.56	46.6	1.83	56.2	2.21	x		x		
Z24	x				●	●	●	■	■	●			147.2	5.80	146.0	5.75	70.0	2.76	68.0	2.68	77.3	3.04	x		x		
Z25	x					●	●	●	■	■			153.3	6.04	152.0	5.98	70.0	2.76	71.0	2.80	80.3	3.16	x		x		

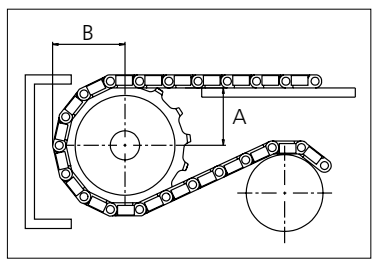
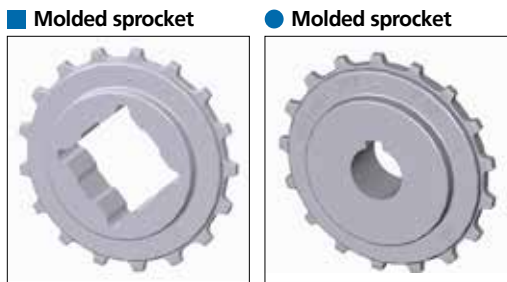

Other sprocket sizes are available upon request.  
 Two-part sprocket are available upon request.  
 Round bores are always delivered with keyway.  
 Other bore sizes are available upon request.  
 uni Retainer Rings: See uni Retainer Ring data sheet  
 Width of tooth = 4.8 mm (0.19 in)  
 Width of sprocket = 25.0 mm (0.98 in)

Max load per sprocket shown does not take bore size into account.  
 Please also ensure that sufficient size shaft is chosen for corresponding load.

For correct sprocket position: See uni Assembly Instructions for uni Light.  
 For more detailed sprocket information. contact Customer Service.

Non standard material and color: See uni Material and Color Overview.

uni Light 10% SR/180314



Expert advice, quality solutions and local service for all your belting needs  
[www.ammeraalbeltech.com](http://www.ammeraalbeltech.com)

**Ammeraal Beltech Modular A/S**  
 Hjulmagervej 21  
 DK-7100 Vejle

T +45 7572 3100  
 F +45 7572 3348  
 admin@unichains.com  
 www.unichains.com

This information is subject to alteration due to continuous development. Ammeraal Beltech will not be held liable for the incorrect use of the above stated information. This information replaces previous information. All activities performed and services rendered by Ammeraal Beltech are subject to general terms and conditions of sale and delivery, as applied by its operating companies.



# Plastic Modular Belt

Series **uni Light** Type **18%**

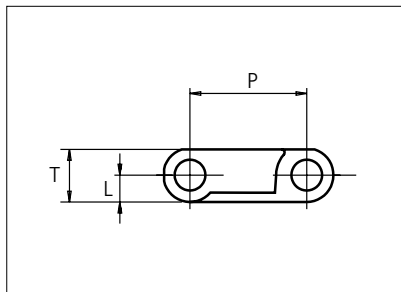

Straight running belt  
 Nominal pitch: 19.1 mm (0.75 in)  
 Surface type: Flat  
 Surface opening: 18%  
 Backflex radius: 25.0 mm (1.0 in)  
 Pin diameter: 5.0 mm (0.20 in)

Recommended Belt material & color	POM-D <b>W</b>	mm	in		mm	in	
		P (Nominal)	19.1	0.75	T	8.5	0.33
Recommended Pin material & color	PA6.6 <b>N</b>	L	4.3	0.17	-	-	-

Non standard material and color: See uni Material and Color Overview.

Alternative pin and lock materials: Pin: PE **W** PP **W** PA6.6 **N** **B** PBT **LG** SS304 PP **W** Lockpin: PBT **LG** PA6.6 **D** **N** PP **W** **B**

Belt width		Permissible tensile force (Belt/pin material)				Belt weight (Belt/pin material)				*Min. No. drive sprocket per shaft	Number of wear strips (Min. No.)	
		POM-LF/PA6.6		PP/PA6.6		POM-LF/PA6.6		PP/PA6.6			**Carry (pcs)	**Return (pcs)
mm	in	N	lbf	N	lbf	kg/m	lb/ft	kg/m	lb/ft			
77	3.0	789	177	395	89	0.4	0.29	0.3	0.21	2	2	2
115	4.5	1175	264	587	132	0.6	0.43	0.5	0.31	2	2	2
153	6.0	1572	353	786	177	0.9	0.58	0.6	0.41	2	2	2
230	9.0	2355	529	1177	265	1.3	0.86	0.9	0.62	2	2	2
306	12.1	3138	705	1569	353	1.7	1.15	1.2	0.82	3	3	2
383	15.1	3921	881	1960	441	2.1	1.44	1.5	1.03	3	3	2
459	18.1	4704	1057	2352	529	2.6	1.73	1.8	1.23	4	4	2
535	21.1	5486	1233	2743	617	3.0	2.01	2.1	1.44	4	4	2
612	24.1	6269	1409	3135	705	3.4	2.30	2.4	1.64	5	5	3
688	27.1	7052	1585	3526	793	3.9	2.59	2.8	1.85	5	5	3
764	30.1	7835	1761	3918	881	4.3	2.88	3.1	2.05	6	6	3
841	33.1	8618	1937	4309	969	4.7	3.16	3.4	2.26	6	6	3
917	36.1	9401	2113	4700	1057	5.1	3.45	3.7	2.47	7	7	4

Additional standard belt widths are available in steps of 76.4 mm (3.01 in). Additional non-standard belt widths are available in steps of 19.1 mm (0.75 in).

1910	75.2	19578	4401	9789	2201	10.7	7.19	7.6	5.13	13	13	7
------	------	-------	------	------	------	------	------	-----	------	----	----	---

Additional standard belt widths are available in steps of 76.4 mm (3.01 in). Additional non-standard belt widths are available in steps of 19.1 mm (0.75 in).

2980	117.3	30545	6867	15273	3433	16.7	11.22	11.9	8.01	20	20	10
------	-------	-------	------	-------	------	------	-------	------	------	----	----	----

General belt tolerance is +0/-0.4% at 23°C/73°F and 50% RH. For exact belt width contact Customer Service. Non standard belt width on request.

\*Max. Load per Drive Sprocket. Belt material: POM-LF 1250 N (281 lbf), PP 700 N (157 lbf)

\*\*Max. Spacing between wear strips, Carry: 152.0 mm (6.00 in); Return: 304.0 mm (12.00 in)

= Single Link



NON STANDARD

STRAIGHT RUNNING

PITCH 19.1 MM/0.75 IN

## Accessories

### Rubber Top

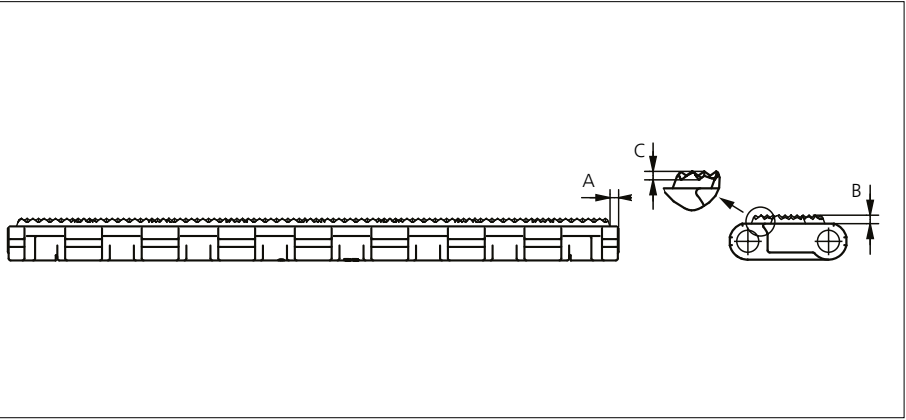

Type	Belt Material & color	Rubber Material & color	A		B		C		Link size	Width	
			mm	in	mm	in	mm	in		mm	in
NON STANDARD Flat	PP <b>K</b>	03 <b>K</b>	2.0	0.08	2.0	0.08	-	-	K300	76.0	2.99
STANDARD Rough							1.0	0.04		K600	114.0

Indent 15.0 mm (0.59 in) is only available in size 228.6 mm (9.00 in) and wider.

## Accessories

### Flight

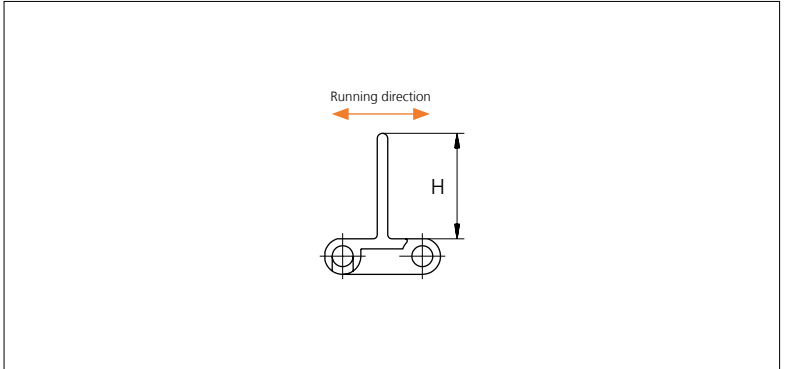
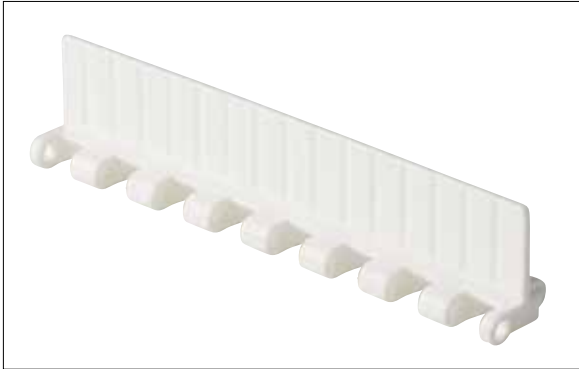

Type	Flight Material & color		H		Link size	Width		Indent	
			mm	in		mm	in	mm	in
Non Stick	PP-I	<b>W</b>	25.4	1.00	K300	76.4	3.01	0.0	0.00
	PP-I	<b>W</b> <b>G</b>							
Non Stick	PA6	<b>K</b>	25.4	1.00	K600	152.8	6.02	0.0	0.00
	04	<b>K</b>							
Non Stick	PP-I	<b>W</b> <b>G</b>	25.4	1.00	K600	152.8	6.02	15.0	0.59
Non Stick/Support Ribs	PP-I	<b>W</b>	25.4	1.00	K600	152.8	6.02	0.0	0.00
Non Stick/Support Ribs	PP-I	<b>W</b> <b>G</b>	50.8	2.00	K600	152.8	6.02	0.0	0.00
	PA6	<b>K</b>							
Non Stick/Support Ribs	PP-I	<b>G</b>	50.8	2.00	K600	152.8	6.02	15.0	0.59
	PA6	<b>K</b>							
Non Stick/Support Ribs	PP-I	<b>W</b> <b>G</b>	76.2	3.00	K600	152.8	6.02	0.0	0.00
Non Stick/Support Ribs	04	<b>K</b>	76.2	3.00	K600	152.8	6.02	0.0	0.00
Non Stick/Support Ribs	PP-I	<b>W</b> <b>G</b>	76.2	3.00	K600	152.8	6.02	15.0	0.59

Other Non Standard material and color: See uni Material and Color Overview.

## Accessories

### Side Guard

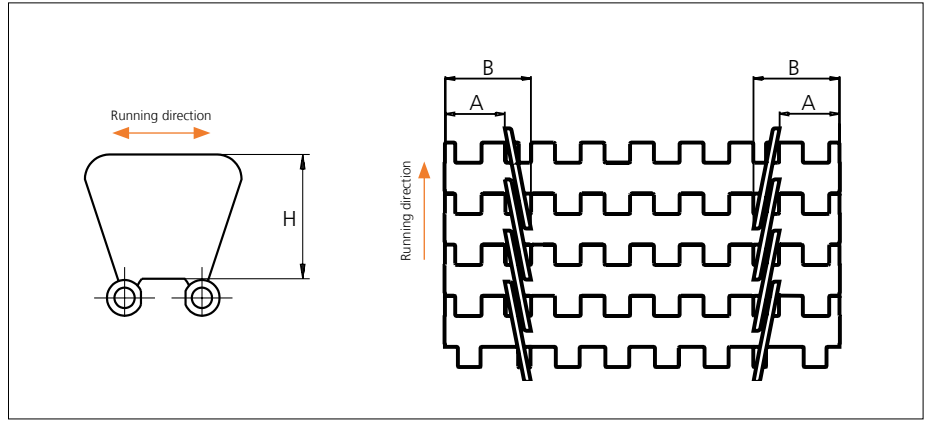

Type	Side Guard Material & color	H		A		B	
		mm	in	mm	in	mm	in
Closed	PP-I <b>W</b> <b>G</b>	31.4	1.24	15.0	0.59	25.0	0.98

Non Standard material and color: See uni Material and Color Overview.

## Accessories

### Tab

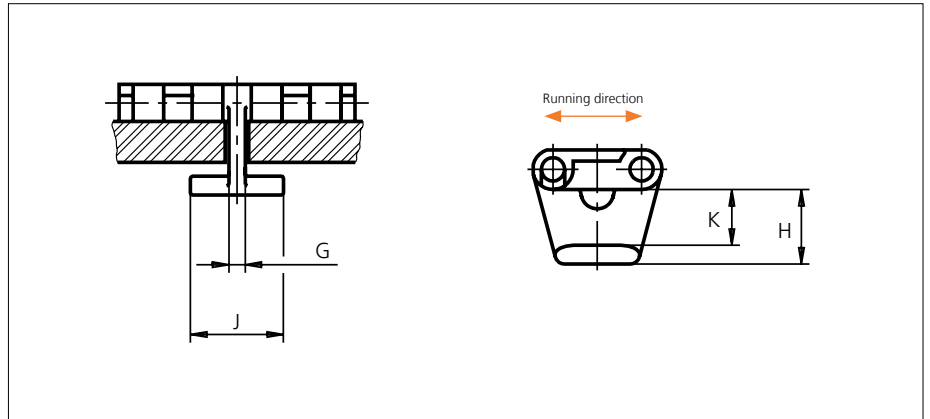

Type	Tab Material & color	G		J		K		H	
		mm	in	mm	in	mm	in	mm	in
Bottom Hold Down	POM-D <b>N</b>	3.5	0.14	20.0	0.79	11.7	0.46	15.9	0.63

Non Standard material and color: See uni Material and Color Overview.

## Sprocket

No of teeth	Bore size													Overall diameter		Pitch-diameter		Hub-diameter		A-dimension		B-dimension		Single row/Two way	Double row/Two way	Molded PA6 LG	Machined PA6 N
	Pilot bore	in	0.75	0.78	0.98	1.00	1.18	1.25	1.50	1.57	2.36	2.50	3.54														
	mm	19.1	20.0	25.0	25.4	30.0	31.8	38.1	40.0	60.0	63.5	90.0	mm	in	mm	in	mm	in	mm	in							
Z07	x	●	●										42.6	1.68	43.9	1.73	30.0	1.18	15.4	0.61	26.3	1.04	x		x		
Z10	x				●	●							61.7	2.43	61.6	2.43	45.0	1.77	25.0	0.98	35.2	1.39	x		x		
Z17	x			●	●	●	●	■	■				105.0	4.13	103.7	4.08	65.0	2.56	46.6	1.83	56.2	2.21	x		x		
Z24	x				●	●	●	■	■	●			147.2	5.80	146.0	5.75	70.0	2.76	68.0	2.68	77.3	3.04	x		x		
Z25	x					●	●	●	●	■	■		153.3	6.04	152.0	5.98	70.0	2.76	71.0	2.80	80.3	3.16	x		x		

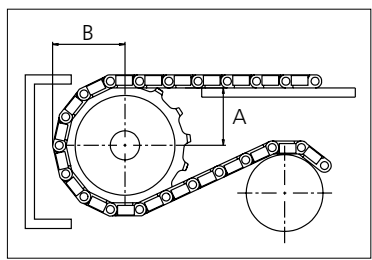
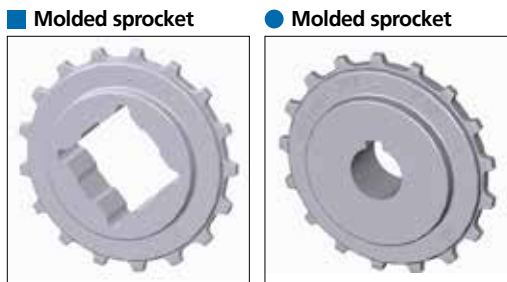

Other sprocket sizes are available upon request.  
 Two-part sprocket are available upon request.  
 Round bores are always delivered with keyway.  
 Other bore sizes are available upon request.  
 uni Retainer Rings: See uni Retainer Ring data sheet  
 Width of tooth = 4.8 mm (0.19 in)  
 Width of sprocket = 25.0 mm (0.98 in)

Max load per sprocket shown does not take bore size into account.  
 Please also ensure that sufficient size shaft is chosen for corresponding load.

For correct sprocket position: See uni Assembly Instructions for uni Light.  
 For more detailed sprocket information. contact Customer Service.

Non standard material and color: See uni Material and Color Overview.



Expert advice, quality solutions and local service for all your belting needs  
[www.ammeraalbeltech.com](http://www.ammeraalbeltech.com)

**Ammeraal Beltech Modular A/S**  
 Hjulmagervej 21  
 DK-7100 Vejle

T +45 7572 3100  
 F +45 7572 3348  
 admin@unichains.com  
 www.unichains.com

This information is subject to alteration due to continuous development. Ammeraal Beltech will not be held liable for the incorrect use of the above stated information. This information replaces previous information. All activities performed and services rendered by Ammeraal Beltech are subject to general terms and conditions of sale and delivery, as applied by its operating companies.





# Plastic Modular Belt

Series **uni Light** Type **Rib**

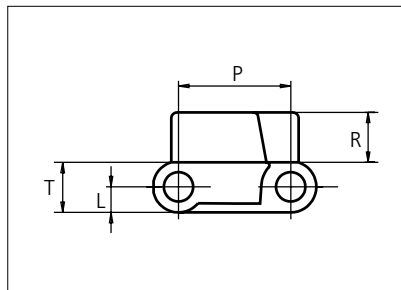

Straight running belt  
 Nominal pitch: 19.1 mm (0.75 in)  
 Surface type: Rib Top  
 Surface opening: Closed  
 Backflex radius: 50.0 mm (2.0 in)  
 Pin diameter:  $\varnothing$ 5.0 mm (0.20 in)

<b>Recommended Belt material &amp; color</b>	POM-LF <b>BR</b>		<b>mm</b>	<b>in</b>		<b>mm</b>	<b>in</b>	
<b>Recommended Pin material &amp; color</b>	PA6.6 <b>N</b>		<b>P (Nominal)</b>	19.1	0.75	<b>T</b>	8.5	0.33
			<b>L</b>	4.3	0.17	<b>R</b>	7.3	0.29

Non standard material and color: See uni Material and Color Overview.

Alternative pin and lock materials: Pin: PE **W** PP **W** PA6.6 **N** **B** PBT **LG** SS304 PP **W** Lockpin: PBT **LG** PA6.6 **D** **N** PP **W** **B**

Belt width		Permissible tensile force (Belt/pin material)						Belt weight (Belt/pin material)						*Min. No. drive sprocket per shaft	Number of wear strips (Min. No.)	
		POM-LF/PA6.6		PP/PA6.6		PA6/PBT-GR		POM-LF/PA6.6		PP/PA6.6		PA6/PBT-GR			**Carry (pcs)	**Return (pcs)
mm	in	N	lbf	N	lbf	N	lbf	kg/m	lb/ft	kg/m	lb/ft	kg/m	lb/ft			
77	3.0	789	177	395	89	789	177	0.5	0.35	0.4	0.25	0.4	0.29	2	2	2
153	6.0	1572	353	786	177	1572	353	1.0	0.70	0.7	0.49	0.9	0.58	2	2	2
230	9.0	2355	529	1177	265	2355	529	1.6	1.05	1.1	0.74	1.3	0.86	2	2	2
306	12.1	3138	705	1569	353	3138	705	2.1	1.40	1.5	0.99	1.7	1.15	3	3	2
383	15.1	3921	881	1960	441	3921	881	2.6	1.75	1.8	1.23	2.1	1.44	3	3	2
459	18.1	4704	1057	2352	529	4704	1057	3.1	2.10	2.2	1.48	2.6	1.73	4	4	2
535	21.1	5486	1233	2743	617	5486	1233	3.6	2.45	2.6	1.73	3.0	2.01	4	4	2
612	24.1	6269	1409	3135	705	6269	1409	4.2	2.80	2.9	1.97	3.4	2.30	5	5	3
688	27.1	7052	1585	3526	793	7052	1585	4.7	3.14	3.3	2.22	3.9	2.59	5	5	3
764	30.1	7835	1761	3918	881	7835	1761	5.2	3.49	3.7	2.47	4.3	2.88	6	6	3
841	33.1	8618	1937	4309	969	8618	1937	5.7	3.84	4.0	2.71	4.7	3.16	6	6	3
917	36.1	9401	2113	4700	1057	9401	2113	6.2	4.19	4.4	2.96	5.1	3.45	7	7	4
994	39.1	10184	2289	5092	1145	10184	2289	6.8	4.54	4.8	3.20	5.6	3.74	7	7	4

Additional standard belt widths are available in steps of 76.4 mm (3.01 in.) Additional non-standard belt widths are available in steps of 19.1 mm (0.75 in.)

1910	75.2	19578	4401	9789	2201	19578	4401	13.0	8.73	9.2	6.16	10.7	7.19	13	13	7
------	------	-------	------	------	------	-------	------	------	------	-----	------	------	------	----	----	---

Additional standard belt widths are available in steps of 76.4 mm (3.01 in.) Additional non-standard belt widths are available in steps of 19.1 mm (0.75 in.)

2980	117.3	30545	6867	15273	3433	30545	6867	20.3	13.62	14.3	9.61	16.7	11.22	20	20	10
------	-------	-------	------	-------	------	-------	------	------	-------	------	------	------	-------	----	----	----

General belt tolerance is +0/-0.4% at 23°C/73°F and 50% RH. For exact belt width contact Customer Service. Non standard belt width on request.

\*Max. Load per Drive Sprocket. Belt material: POM-LF 1250 N (281 lbf), PP 700 N (157 lbf), PA6 1250 N (281 lbf)

\*\*Max. Spacing between wear strips, Carry: 152 mm (6 in.); Return: 304 mm (12 in.)

= Single Link



NON STANDARD

STRAIGHT RUNNING

PITCH 19.1 MM/0.75 IN

## Accessories

### Finger plates

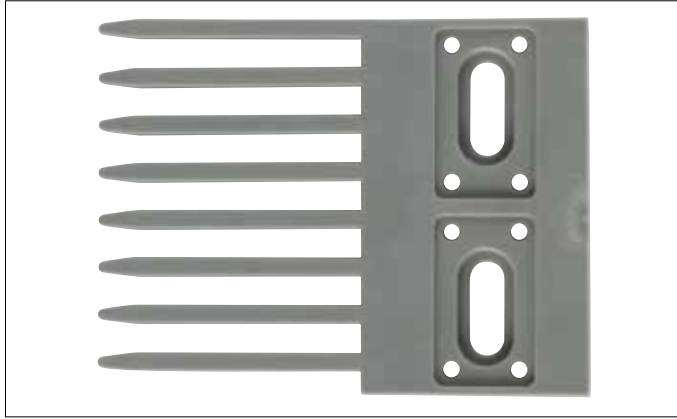

Single Sided

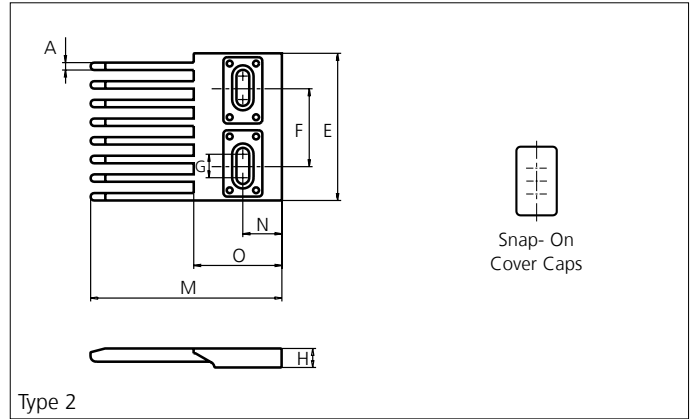

Type 2

Single Sided

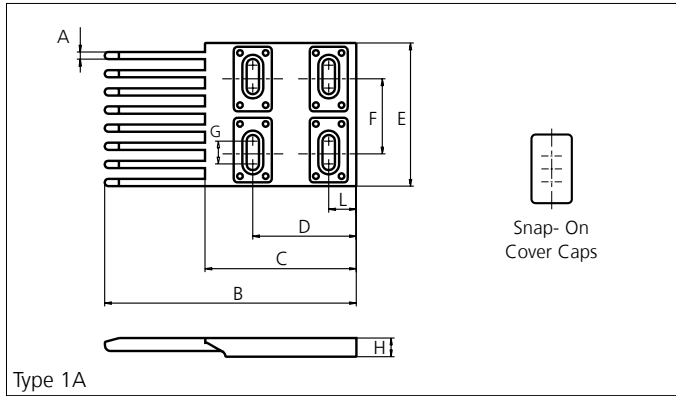

Type 1A

Double Sided

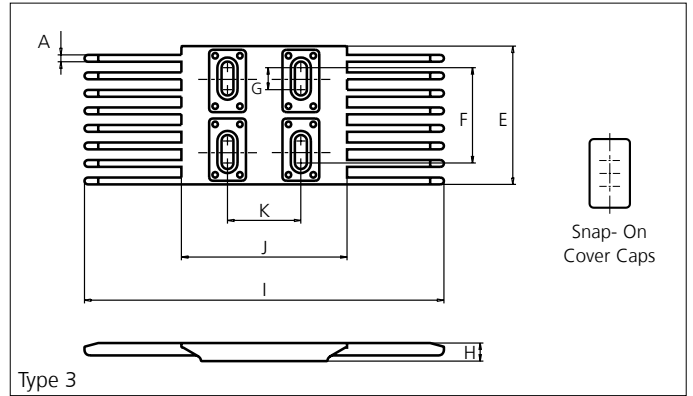

Type 3

Type	Material & color	A		B		C		D		E		F	
		mm	in	mm	in	mm	in	mm	in	mm	in	mm	in
Single Sided	POM-LF <b>BR</b>	3.8	0.15	132.9	5.23	80.0	3.15	14.9	0.59	75.4	2.97	40.0	1.57
Single Sided	POM-DI <b>G</b>												
Double Sided	POM-EC <b>K</b>												

G		H		I		J		K		L		M		N		O	
mm	in	mm	in	mm	in	mm	in	mm	in	mm	in	mm	in	mm	in	mm	in
12.0	0.47	10.0	0.39	197.1	7.76	90.3	3.56	40.0	1.57	54.5	2.15	98.9	3.89	20.0	0.79	45.2	1.78

All uni-chains belt systems are available in a raised rib version that can be supplied with matching finger plates, also called combs.

The finger plates are supplied with cover caps which can be attached when the finger plate has been installed. The cover caps can be removed by using a screwdriver that can be inserted between the cover and finger plate. In order to adjust to belt width variations caused by temperature fluctuations, a slider facilitates the sideways movement of the finger plates.

Non Standard material and color: See uni Material and Color Overview.

## Sprocket

No of teeth	Pilot bore	Bore size												Overall diameter		Pitch diameter		Hub diameter		A-dimension		B-dimension		Single row/Two way	Double row/Two way	Material	
		in	0.75	0.78	0.98	1.00	1.18	1.25	1.50	1.57	2.36	2.50	3.54													PA6	LG
		mm	19.1	20.0	25.0	25.4	30.0	31.8	38.1	40.0	60.0	63.5	90.0	mm	in	mm	in	mm	in	mm	in	Molded	Machined				
Z07	x		●	●									42.6	1.68	43.9	1.73	30.0	1.18	15.4	0.61	26.3	1.04	x		x		
Z10	x					●	●						61.7	2.43	61.6	2.43	45.0	1.77	25.0	0.98	35.2	1.39	x		x		
Z17	x				●	●	●	●	■	■			105.0	4.13	103.7	4.08	65.0	2.56	46.6	1.83	56.2	2.21	x		x		
Z24	x					●	●	●	■	■	●		147.2	5.80	146.0	5.75	70.0	2.76	68.0	2.68	77.3	3.04	x		x		
Z25	x						●	●	■	■	●		153.3	6.04	152.0	5.98	70.0	2.76	71.0	2.80	80.3	3.16	x		x		

■ Molded sprocket

● Molded sprocket

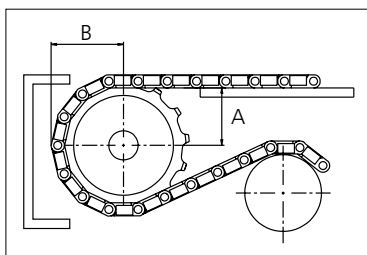
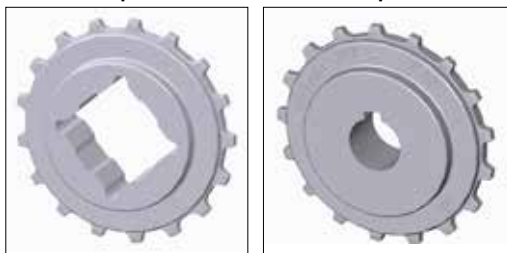

Other sprocket sizes are available upon request.  
 Two-part sprocket are available upon request.  
 Round bores are always delivered with keyway.  
 Other bore sizes are available upon request.  
 uni Retainer Rings: See uni Retainer Ring data sheet  
 Width of tooth = 4.8 mm (0.19 in)  
 Width of sprocket = 25.0 mm (0.98 in)

Max load per sprocket shown does not take bore size into account.  
 Please also ensure that sufficient size shaft is chosen for corresponding load.

For correct sprocket position: See uni Assembly Instructions for uni Light.  
 For more detailed sprocket information, contact Customer Service.

Non standard material and color: See uni Material and Color Overview.



Conveyor



Seamless



Modular



Timing



Transmission



Fabrication & service

*Solid advice*  
*For all your belting needs*  
*Local stock & service*  
[www.ammeraalbeltech.com](http://www.ammeraalbeltech.com)

**Ammeraal Beltech Modular A/S**  
Hjulmagervej 21  
DK-7100 Vejle

T +45 7572 3100  
F +45 7572 3348  
admin@unichains.com  
www.unichains.com

This information is subject to alteration due to continuous development. Ammeraal Beltech will not be held liable for the incorrect use of the above stated information. This information replaces previous information. All activities performed and services rendered by Ammeraal Beltech are subject to general terms and conditions of sale and delivery, as applied by its operating companies.



# Plastic Modular Belt

Series **uni Light** Type **Vacuum**

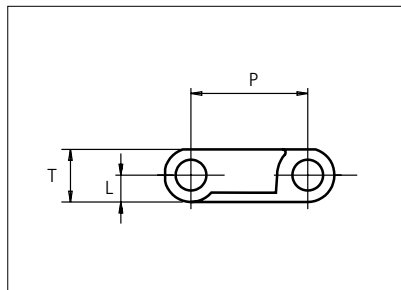
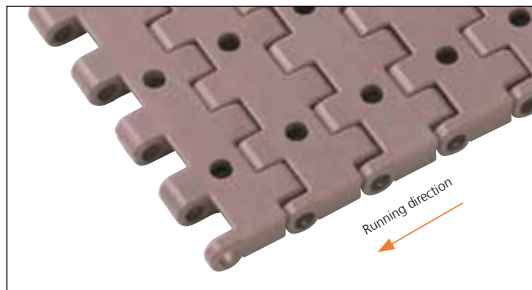

Straight running belt  
 Nominal pitch: 19.1 mm (0.75 in)  
 Surface type: Flat  
 Surface opening: Closed  
 Backflex radius: 25.0 mm (1.00 in)  
 Pin diameter: 5.0 mm (0.20 in)  
**Vacuum holes:** ø3.2 mm (0.13 in)  
 ø4.0 mm (0.16 in)  
 ø5.2 mm (0.20 in)  
 ø5.6 mm (0.22 in)

<b>Recommended Belt material &amp; color</b>	POM-LF <b>BR</b>	<b>mm</b>	<b>in</b>		<b>mm</b>	<b>in</b>	
<b>Recommended Pin material &amp; color</b>	PA6.6 <b>N</b>	<b>P (Nominal)</b>	19.1	0.75	<b>T</b>	8.5	0.33
		<b>L</b>	4.3	0.17	-	-	-

Non standard material and color: See uni Material and Color Overview.

Alternative pin and lock materials: Pin: PE **W** PP **W** PA6.6 **N** **B** PBT **LG** SS304 PP **W** Lockpin: PBT **LG** PA6.6 **D** **N** PP **W** **B**

Belt width		Permissible tensile force (Belt/pin material)						Belt weight (Belt/pin material)						*Min. No. drive sprocket per shaft	Number of wear strips (Min. No.)	
		POM-LF/PA6.6		PP/PA6.6		PA6/PBT-GR		POM-LF/PA6.6		PP/PA6.6		PA6/PBT-GR			**Carry (pcs)	**Return (pcs)
mm	in	N	lbf	N	lbf	N	lbf	kg/m	lb/ft	kg/m	lb/ft	kg/m	lb/ft			
77	3.0	789	177	395	89	789	177	0.5	0.35	0.4	0.25	0.4	0.29	2	2	2
153	6.0	1572	353	786	177	1572	353	1.0	0.70	0.7	0.49	0.9	0.58	2	2	2
230	9.0	2355	529	1177	265	2355	529	1.6	1.05	1.1	0.74	1.3	0.86	2	2	2
306	12.1	3138	705	1569	353	3138	705	2.1	1.40	1.5	0.99	1.7	1.15	3	3	2
383	15.1	3921	881	1960	441	3921	881	2.6	1.75	1.8	1.23	2.1	1.44	3	3	2
459	18.1	4704	1057	2352	529	4704	1057	3.1	2.10	2.2	1.48	2.6	1.73	4	4	2
535	21.1	5486	1233	2743	617	5486	1233	3.6	2.45	2.6	1.73	3.0	2.01	4	4	2
612	24.1	6269	1409	3135	705	6269	1409	4.2	2.80	2.9	1.97	3.4	2.30	5	5	3
688	27.1	7052	1585	3526	793	7052	1585	4.7	3.14	3.3	2.22	3.9	2.59	5	5	3
764	30.1	7835	1761	3918	881	7835	1761	5.2	3.49	3.7	2.47	4.3	2.88	6	6	3
841	33.1	8618	1937	4309	969	8618	1937	5.7	3.84	4.0	2.71	4.7	3.16	6	6	3
917	36.1	9401	2113	4700	1057	9401	2113	6.2	4.19	4.4	2.96	5.1	3.45	7	7	4
994	39.1	10184	2289	5092	1145	10184	2289	6.8	4.54	4.8	3.20	5.6	3.74	7	7	4

Additional standard belt widths are available in steps of 76.4 mm (3.01 in.) Additional non-standard belt widths are available in steps of 19.1 mm (0.75 in.)

1910	75.2	19578	4401	9789	2201	19578	4401	13.0	8.73	9.2	6.16	10.7	7.19	13	13	7
------	------	-------	------	------	------	-------	------	------	------	-----	------	------	------	----	----	---

Additional standard belt widths are available in steps of 76.4 mm (3.01 in.) Additional non-standard belt widths are available in steps of 19.1 mm (0.75 in.)

2980	117.3	30545	6867	15273	3433	30545	6867	20.3	13.62	14.3	9.61	16.7	11.22	20	20	10
------	-------	-------	------	-------	------	-------	------	------	-------	------	------	------	-------	----	----	----

General belt tolerance is +/-0.4% at 23°C/73°F and 50% RH. For exact belt width contact Customer Service. Non standard belt width on request.

\*Max. Load per Drive Sprocket. Belt material: POM-LF 1250 N (281 lbf), PP 700 N (157 lbf), PA6 1250 N (281 lbf)

\*\*Max. Spacing between wear strips, Carry: 152 mm (6 in); Return: 304 mm (12 in)

= Single Link



NON STANDARD

STRAIGHT RUNNING

PITCH 19.1 MM/0.75 IN

## Sprocket

No of teeth	Bore size													Overall diameter		Pitch-diameter		Hub-diameter		A-dimension		B-dimension		Single row/Two way	Double row/Two way	Molded PA6 LG	Machined PA6 N
	Pilot bore	in	0.75	0.78	0.98	1.00	1.18	1.25	1.50	1.57	2.36	2.50	3.54														
	mm	19.1	20.0	25.0	25.4	30.0	31.8	38.1	40.0	60.0	63.5	90.0	mm	in	mm	in	mm	in	mm	in							
Z07	x	●	●										42.6	1.68	43.9	1.73	30.0	1.18	15.4	0.61	26.3	1.04	x		x		
Z10	x				●	●							61.7	2.43	61.6	2.43	45.0	1.77	25.0	0.98	35.2	1.39	x		x		
Z17	x			●	●	●	●	■	■				105.0	4.13	103.7	4.08	65.0	2.56	46.6	1.83	56.2	2.21	x		x		
Z24	x				●	●	●	■	■	●			147.2	5.80	146.0	5.75	70.0	2.76	68.0	2.68	77.3	3.04	x		x		
Z25	x					●	●	●	●	■	■		153.3	6.04	152.0	5.98	70.0	2.76	71.0	2.80	80.3	3.16	x		x		

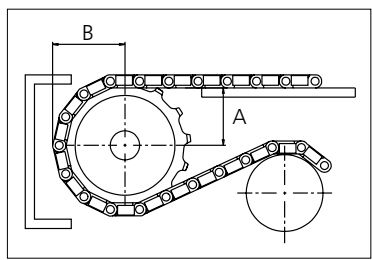
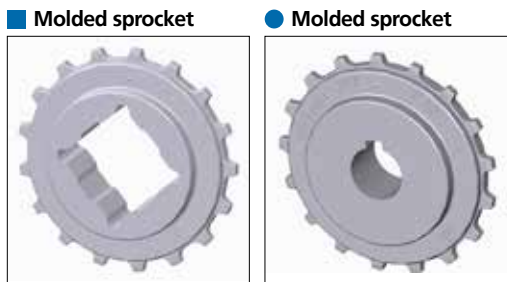

Other sprocket sizes are available upon request.  
 Two-part sprocket are available upon request.  
 Round bores are always delivered with keyway.  
 Other bore sizes are available upon request.  
 uni Retainer Rings: See uni Retainer Ring data sheet  
 Width of tooth = 4.8 mm (0.19 in)  
 Width of sprocket = 25.0 mm (0.98 in)

Max load per sprocket shown does not take bore size into account.  
 Please also ensure that sufficient size shaft is chosen for corresponding load.

For correct sprocket position: See uni Assembly Instructions for uni Light.  
 For more detailed sprocket information. contact Customer Service.

Non standard material and color: See uni Material and Color Overview.



Expert advice, quality solutions and local service for all your belting needs  
[www.ammeraalbeltech.com](http://www.ammeraalbeltech.com)

**Ammeraal Beltech Modular A/S**  
 Hjulmagervej 21  
 DK-7100 Vejle

T +45 7572 3100  
 F +45 7572 3348  
 admin@unichains.com  
 www.unichains.com

This information is subject to alteration due to continuous development. Ammeraal Beltech will not be held liable for the incorrect use of the above stated information. This information replaces previous information. All activities performed and services rendered by Ammeraal Beltech are subject to general terms and conditions of sale and delivery, as applied by its operating companies.



# Plastic Modular Belt

Serie **uni Light EP** Type **C**

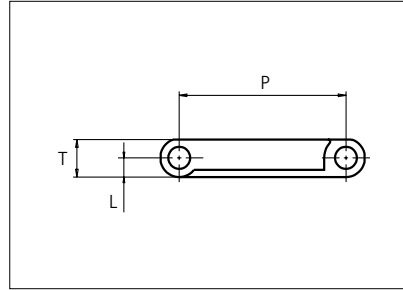

Straight running belt  
 Nominal pitch: 38.1 mm (1.50 in)  
 Surface type: Flat  
 Surface opening: Closed  
 Backflex radius: 75.0 mm (3.0 in)  
 Pin diameter: 5.0 mm (0.20 in)

<b>Recommended Belt material &amp; color</b>	POM-D	<b>mm</b>	<b>in</b>		<b>mm</b>	<b>in</b>	
<b>Recommended Pin and lock material &amp; color</b>	PP	<b>P (Nominal)</b>	38.1	1.50	<b>T</b>	8.5	0.33
		<b>L</b>	4.3	0.17	-	-	-

Non standard material and color: See uni Material and Color Overview.

Alternative materials: Belt: PP and PE Pin: PP PA6.6 PE PBT and SS304 PP PP

Lockpin: PBT PA6.6

Belt width		Permissible tensile force (Belt/pin material)						Belt weight (Belt/pin material)						*Min. No. drive sprocket per shaft	Number of wear strips (Min. No.)	
		POM-D/PP		PP/PP		PE/PP		POM-D/PP		PP/PP		PE/PP			**Carry (pcs)	**Return (pcs)
mm	in	N	lbf	N	lbf	N	lbf	kg/m	lb/ft	kg/m	lb/ft	kg/m	lb/ft			
64	2.5	653	147	326	73	196	44	0.4	0.24	0.2	0.16	0.3	0.17	2	2	2
83	3.3	848	191	424	95	255	57	0.5	0.32	0.3	0.21	0.3	0.22	2	2	2
102	4.0	1046	235	523	118	314	71	0.6	0.39	0.4	0.25	0.4	0.27	2	2	2
115	4.5	1175	264	587	132	352	79	0.7	0.44	0.4	0.28	0.5	0.31	2	2	2
153	6.0	1568	353	784	176	470	106	0.9	0.59	0.6	0.38	0.6	0.41	2	2	2
191	7.5	1958	440	979	220	587	132	1.1	0.73	0.7	0.47	0.8	0.51	2	2	2
204	8.0	2091	470	1046	235	627	141	1.2	0.78	0.8	0.51	0.8	0.55	2	2	2
255	10.0	2614	588	1307	294	784	176	1.5	0.98	0.9	0.63	1.0	0.69	2	2	2
306	12.0	3137	705	1568	353	941	212	1.7	1.17	1.1	0.76	1.2	0.82	3	3	2
357	14.1	3659	823	1830	411	1098	247	2.0	1.37	1.3	0.89	1.4	0.96	3	3	2
408	16.1	4182	940	2091	470	1255	282	2.3	1.56	1.5	1.01	1.6	1.10	3	3	2
459	18.1	4705	1058	2352	529	1411	317	2.6	1.76	1.7	1.14	1.8	1.23	4	4	2
510	20.1	5228	1175	2614	588	1568	353	2.9	1.95	1.9	1.27	2.0	1.37	4	4	2

Additional standard belt widths are available in steps of 50.9 mm (2.00 in). Additional non-standard belt widths are available in steps of 12.7 mm (0.50 in).

1987	78.2	20367	4578	10183	2289	6110	1374	11.3	7.61	7.4	4.94	7.9	5.34	14	14	7
------	------	-------	------	-------	------	------	------	------	------	-----	------	-----	------	----	----	---

Additional standard belt widths are available in steps of 50.9 mm (2.00 in). Additional non-standard belt widths are available in steps of 12.7 mm (0.50 in).

2955	116.3	30289	6809	15144	3404	9087	2043	16.8	11.32	10.9	7.35	11.8	7.94	20	20	10
------	-------	-------	------	-------	------	------	------	------	-------	------	------	------	------	----	----	----

General belt tolerance is +0/-0.4% at 23°C/73°F and 50% RH. For exact belt width contact Customer Service. Non standard belt width on request.

\*Max. Load per Drive Sprocket. Belt material: POM-D 1000 N (225 lbf). PP 600 N (135 lbf). PE 600 N (135 lbf)

\*\*Max. Spacing between wear strips. Carry: 152.0 mm (6.00 in); Return: 304.0 mm (12.00 in)

= Single Link



NON STANDARD

STRAIGHT RUNNING

PITCH 38.1 MM/1.50 IN

## Accessories

### Flight

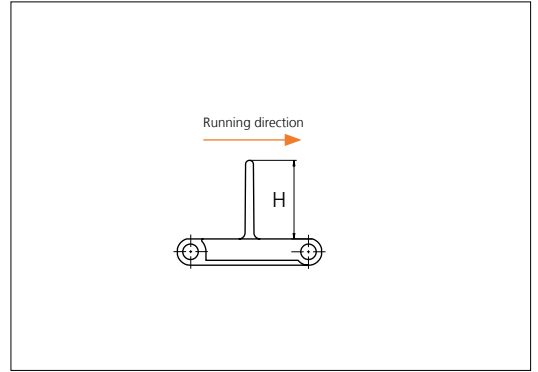
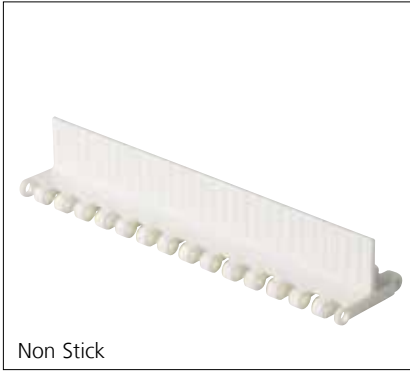

Type	Recommended Material & color	H		Link size	Width		Indent left/right	
		mm	in		mm	in	mm	in
Non Stick	POM-D <b>W</b>	25.4	1.00	K750	191.0	7.52	0.0	0.00
		50.8	2.00				17.5	0.69
Non Stick/ Support Ribs	POM-D <b>W</b>	25.4	1.00	K400	101.6	4.00	0.0	0.00
				K600	152.8	6.02	0.0	0.00
		50.8	2.00	K400	101.6	4.00	0.0	0.00
				K600	152.8	6.02	0.0	0.00
76.2	3.00	K600	152.8	6.02	0.0	0.00		

Minimum bricklaid indent for uni Light EP flights is 38.1 mm (1.50 in). increment: 12.7 mm (0.50 in).

Alternative materials: PP-I, PE.

Non Standard material and color: See uni Material and Color Overview.

## Accessories

### Side Guard

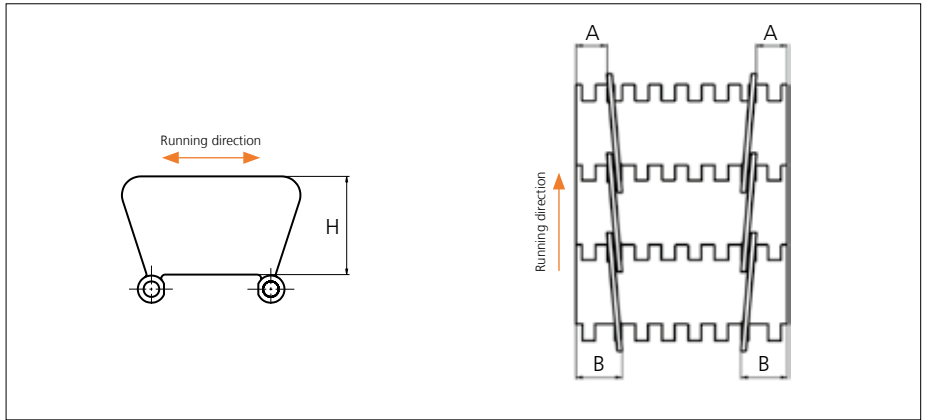

Type	Recommended Material & color	H		A		B	
		mm	in	mm	in	mm	in
Closed	POM-D <b>W</b>	31.7	1.25	15.0	0.59	23.0	0.91

Other Non Standard material and color: See uni Material and Color Overview.



## Accessories

### Tab

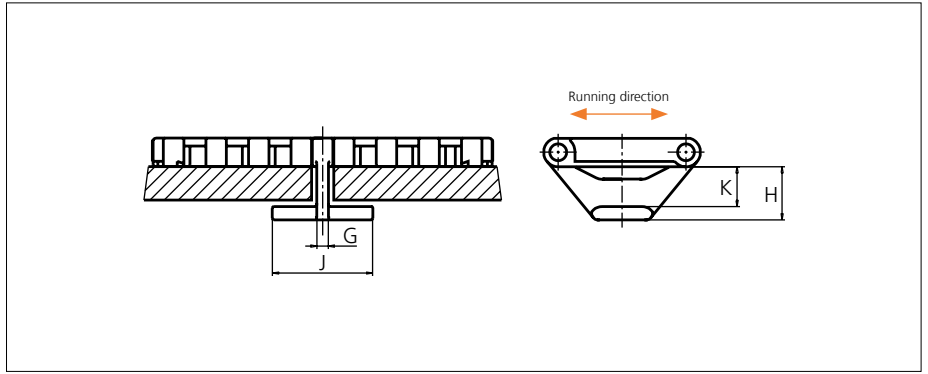

Type	Recommended Material & color	G		J		K		H	
		mm	in	mm	in	mm	in	mm	in
Bottom Hold Down	POM-D 	3.5	0.14	26.0	1.02	12.4	0.49	16.4	0.65

Other Non Standard material and color: See uni Material and Color Overview.

## Accessories

### Non Standard uni AmFlight

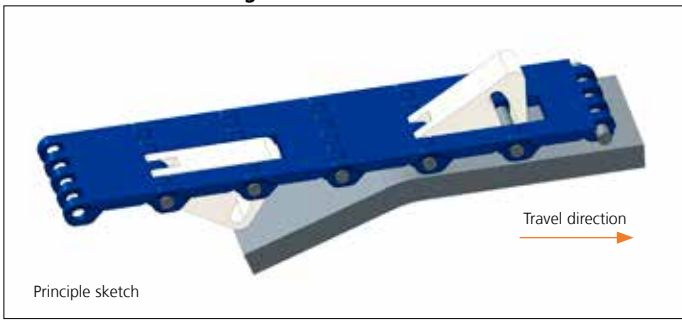

Other Non Standard option: See uni AmFlight Overview.

## Sprocket

No. of teeth	Bore size						Overall diameter		Pitch-diameter		Hub-diameter		Dimension A		Dimension B		Single row/Two way	Molded	LG
	Pilot bore	in	1.00	1.18	1.25	1.50													
	mm	25.4	30.0	31.8	38.1	40.0	mm	in	mm	in	mm	in	mm	in	mm	in			
Z07		●	●	●			87.8	3.46	86.0	3.39	65.0	2.56	35.2	1.39	48.3	1.90	✓	✓	
Z09		●	●	●	■	●	111.4	4.39	110.6	4.35	90.0	3.54	48.0	1.89	60.0	2.36	✓	✓	
Z10		●	●	●	■	■	123.3	4.85	122.7	4.83	100.0	3.94	54.3	2.14	66.0	2.60	✓	✓	
Z11		●	●	●	■	■	135.2	5.32	135.0	5.31	110.0	4.33	60.5	2.38	72.0	2.83	✓	✓	
Z12			●	●	■	■	147.2	5.80	147.1	5.79	120.0	4.72	66.7	2.63	78.0	3.07	✓	✓	
Z15			●	●	■	■	183.2	7.21	183.5	7.22	120.0	4.72	85.3	3.36	96.0	3.78	✓	✓	

■ Molded sprocket ● Molded sprocket

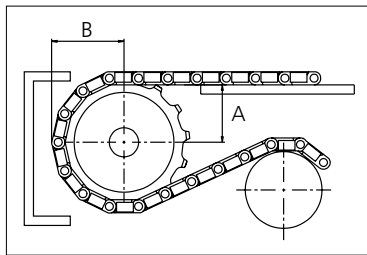
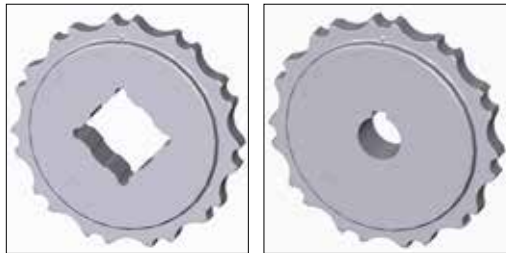

Non standard material and color: See uni Material and Color Overview.

Other sprocket sizes are available upon request.  
 Two-part sprocket are available upon request.  
 Other bore sizes are available upon request  
 uni Retainer Rings: See uni Retainer Ring data sheet  
 Width of tooth = 11.8 mm (0.47 in)  
 Width of sprocket = 23.2 mm (0.91 in)

Max load per sprocket shown does not take bore size into account.  
 Please also ensure that sufficient size shaft is chosen for corresponding load.

For correct sprocket position: See uni Assembly Instructions for uni Light EP.  
 For more detailed sprocket information. contact Customer Service.

uni Light EP C/2019.05.29



Solid advice  
 For all your belting needs  
 Local stock & service  
[www.ammeraalbeltech.com](http://www.ammeraalbeltech.com)

**Ammeraal Beltech Modular A/S**  
 Hjulmagervej 21  
 DK-7100 Vejle

T +45 7572 3100  
 F +45 7572 3348  
 admin@unichains.com  
 www.unichains.com

This information is subject to alteration due to continuous development. Ammeraal Beltech will not be held liable for the incorrect use of the above stated information. This information replaces previous information. All activities performed and services rendered by Ammeraal Beltech are subject to general terms and conditions of sale and delivery, as applied by its operating companies.



# Plastic Modular Belt

Serie **uni Light EP** Type **22% Fine-meshed**

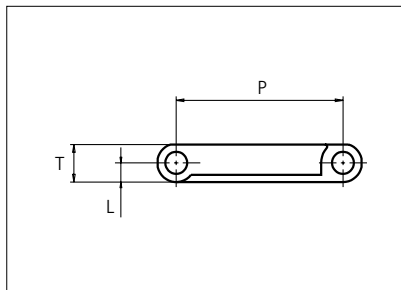

Straight running belt  
 Nominal pitch: 38.1 mm (1.50 in)  
 Surface type: Flat  
 Surface opening: 22%  
 Backflex radius: 75.0 mm (3.0 in)  
 Pin diameter: 5.0 mm (0.20 in)

Belt material & color	PP-HW <b>W</b>	PP-HW <b>B</b>	mm	in	mm	in		
	Pin and lock material & color	PP-HW <b>W</b> PP-HW <b>W</b>	PP-HW <b>B</b> PP-HW <b>B</b>	<b>P (Nominal)</b>	38.1	1.50	<b>T</b>	8.5
			<b>L</b>	4.3	0.17	-	-	-

Non standard material and color: See uni Material and Color Overview.

Alternative pin and lock materials: Pin: PE **W** PP-HW **W** **B** SS304 Lockpin: PBT **LG** PA6.6 **N** **D**

Belt width		Permissible tensile force (Belt/pin material)		Belt weight (Belt/pin material)		*Min. No. drive sprocket per shaft	Number of wear strips (Min. No.)	
		PP-HW		PP-HW			**Carry (pcs)	**Return (pcs)
mm	in	N	lbf	kg/m	lb/ft			
64	2.5	325	73	0.2	0.15	2	2	2
102	4.0	523	118	0.3	0.23	2	2	2
153	6.0	784	176	0.5	0.35	2	2	2
191	7.5	979	220	0.6	0.44	2	2	2
204	8.0	1046	235	0.7	0.47	2	2	2
255	10.0	1307	294	0.9	0.58	2	2	2
306	12.0	1568	353	1.0	0.70	3	3	2
357	14.1	1830	411	1.2	0.82	3	3	2
408	16.1	2091	470	1.4	0.93	3	3	2
459	18.1	2352	529	1.6	1.05	4	4	2
510	20.1	2614	588	1.7	1.17	4	4	2
561	22.1	2875	646	1.9	1.28	4	4	2
612	24.1	3137	705	2.1	1.40	5	5	3

Additional standard belt widths are available in steps of 50.9 mm (2.00 in). Additional non-standard belt widths are available in steps of 12.7 mm (0.50 in).

1987	78.2	10183	2289	6.8	4.54	14	14	7
------	------	-------	------	-----	------	----	----	---

Additional standard belt widths are available in steps of 50.9 mm (2.00 in). Additional non-standard belt widths are available in steps of 12.7 mm (0.50 in).

2955	116.3	15144	3404	10.0	6.75	20	20	10
------	-------	-------	------	------	------	----	----	----

General belt tolerance is +0/-0.4% at 23°C/73°F and 50% RH. For exact belt width contact Customer Service. Non standard belt width on request.

\*Max. Load per Drive Sprocket. Belt material: PP-HW 600 N (135 lbf)

\*\*Max. Spacing between wear strips. Carry: 152.0 mm (6.00 in); Return: 304.0 mm (12.00 in)

= Single Link



STANDARD

STRAIGHT RUNNING

PITCH 38.1 MM/1.50 IN

## Accessories

### Flight/NON STANDARD

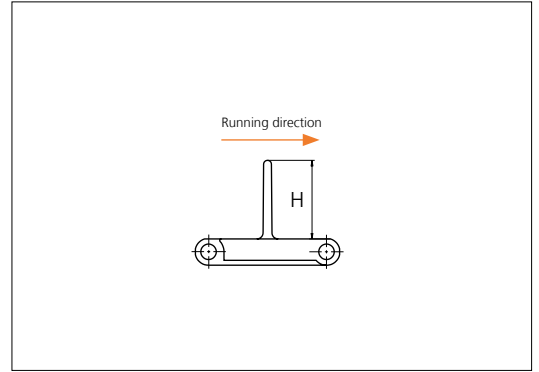
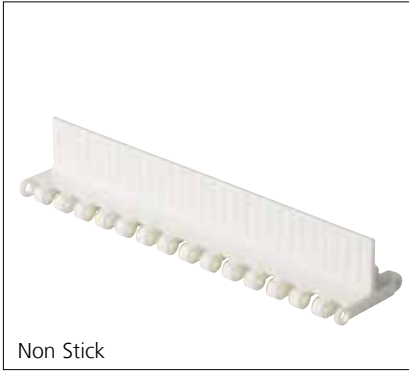

Type	Recommended Material & color	H		Link size	Width		Indent left/right	
		mm	in		mm	in	mm	in
Non Stick	POM-D <b>W</b>	25.4	1.00	K750	191.0	7.52	0.0	0.00
		50.8	2.00				17.5	0.69
Non Stick/ Support Ribs	POM-D <b>W</b>	25.4	1.00	K400	101.6	4.00	0.0	0.00
				K600	152.8	6.02	0.0	0.00
		50.8	2.00	K400	101.6	4.00	0.0	0.00
				K600	152.8	6.02	0.0	0.00
76.2	3.00	K600	152.8	6.02	0.0	0.00		

Minimum bricklaid indent for uni Light EP flights is 38.1 mm (1.50 in), increment: 12.7 mm (0.50 in).

Alternative materials: PP-I, PE.

Non Standard material and color: See uni Material and Color Overview.

## Accessories

### Side Guard/NON STANDARD

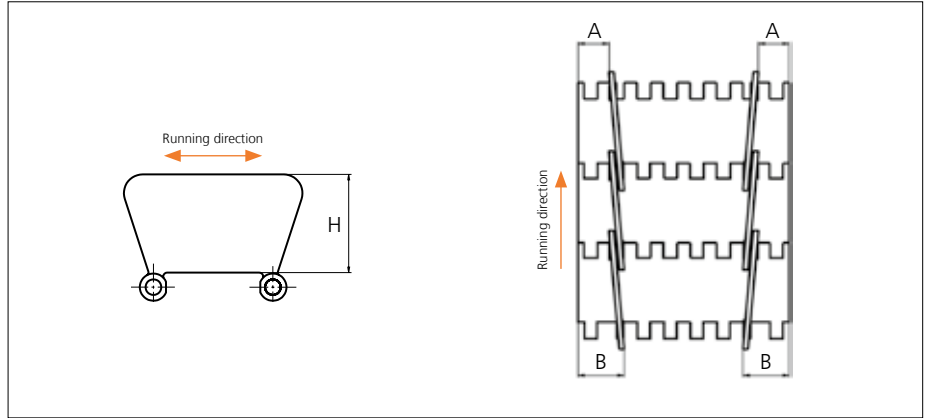

Type	Recommended Material & color	H		A		B	
		mm	in	mm	in	mm	in
Closed	POM-D <b>W</b>	31.7	1.25	15.0	0.59	23.0	0.91

Other Non Standard material and color: See uni Material and Color Overview.

## Accessories

### Tab/NON STANDARD

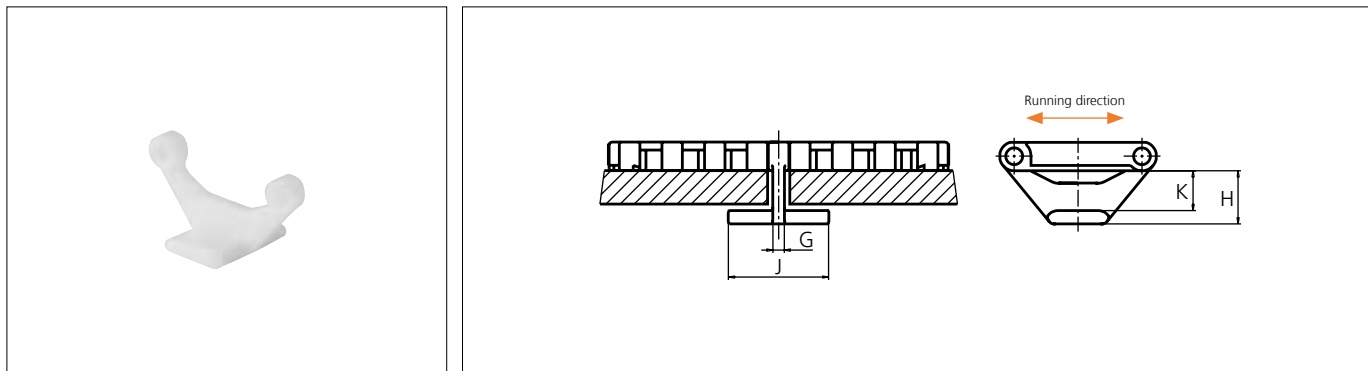

Type	Reccomeded Material & color	G		J		K		H	
		mm	in	mm	in	mm	in	mm	in
Bottom Hold Down	POM-D	3.5	0.14	26.0	1.02	12.4	0.49	16.4	0.65

Other Non Standard material and color: See uni Material and Color Overview.

## Accessories

### Reinforcement Link



The use of uni-chains belts with the SS reinforcement /pitch control links in blanchers, cookers and other high temperature applications will reduce belt elongation due to temperature by more than 90%. This will simplify the belt take-up system and reduce maintenance. uni-chains recommends one reinforcement link per K600 module. Note: Reinforcement links require the use of SS pins.

Type	Material & color	N/row	Lbf/row
Steel Link	SS316	1000	225

Non Standard material and color: See uni Material and Color Overview.

## Accessories

### Non Standard uni AmFlight

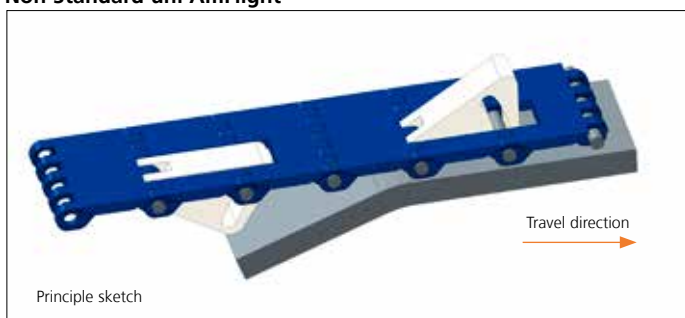

Other Non Standard option: See uni AmFlight Overview.

## Sprocket

No. of teeth	Bore size						Overall diameter		Pitch-diameter		Hub-diameter		Dimension A		Dimension B		Single row/Two way	Molded	PA6 LG
	Pilot bore	in	1.00	1.18	1.25	1.50													
	mm	25.4	30.0	31.8	38.1	40.0	mm	in	mm	in	mm	in	mm	in	mm	in			
Z07	x	●	●	●			87.8	3.46	86.0	3.39	65.0	2.56	35.2	1.39	48.3	1.90	✓	✓	
Z09	x	●	●	●	■	●	111.4	4.39	110.6	4.35	90.0	3.54	48.0	1.89	60.0	2.36	✓	✓	
Z10	x	●	●	●	■	●	123.3	4.85	122.7	4.83	100.0	3.94	54.3	2.14	66.0	2.60	✓	✓	
Z11	x	●	●	●	■	●	135.2	5.32	135.0	5.31	110.0	4.33	60.5	2.38	72.0	2.83	✓	✓	
Z12	x		●	●	●	●	147.2	5.80	147.1	5.79	120.0	4.72	66.7	2.63	78.0	3.07	✓	✓	
Z15	x		●	●	●	●	183.2	7.21	183.5	7.22	120.0	4.72	85.3	3.36	96.0	3.78	✓	✓	

■ Molded sprocket ● Molded sprocket

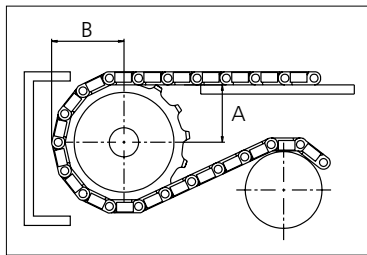
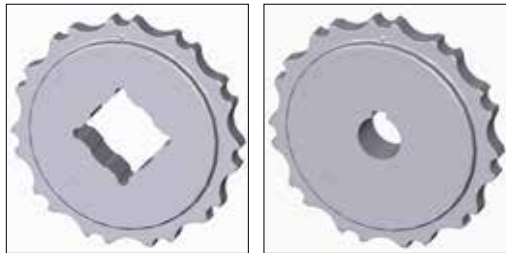

Non standard material and color: See uni Material and Color Overview.

Other sprocket sizes are available upon request.  
 Two-part sprocket are available upon request.  
 Other bore sizes are available upon request.  
 uni Retainer Rings: See uni Retainer Ring data sheet  
 Width of tooth = 11.8 mm (0.47 in)  
 Width of sprocket = 23.2 mm (0.91 in)

Max load per sprocket shown does not take bore size into account.  
 Please also ensure that sufficient size shaft is chosen for corresponding load.

For correct sprocket position: See uni Assembly Instructions for uni Light EP.  
 For more detailed sprocket information. contact Customer Service.

uni Light EP 22%/2019.05.29



Expert advice, quality solutions and local service for all your belting needs  
[www.ammeraalbeltech.com](http://www.ammeraalbeltech.com)

**Ammeraal Beltech Modular A/S**  
 Hjulmagervej 21  
 DK-7100 Vejle

T +45 7572 3100  
 F +45 7572 3348  
 admin@unichains.com  
 www.unichains.com

This information is subject to alteration due to continuous development. Ammeraal Beltech will not be held liable for the incorrect use of the above stated information. This information replaces previous information. All activities performed and services rendered by Ammeraal Beltech are subject to general terms and conditions of sale and delivery, as applied by its operating companies.



# Plastic Modular Belt

Serie **uni Light EP** Type **Rib**

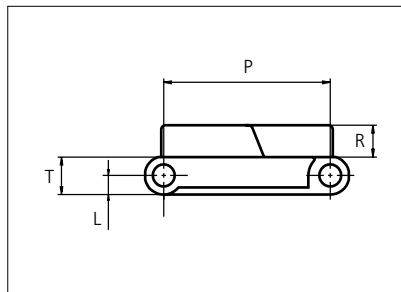
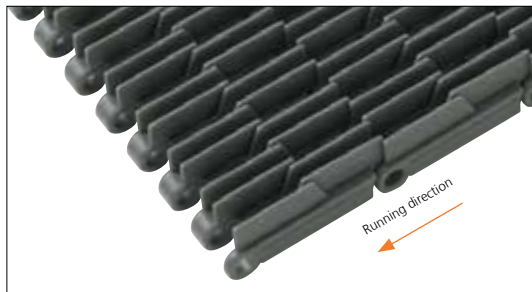

Straight running belt  
 Nominal pitch: 38.1 mm (1.50 in)  
 Surface type: Rib Top  
 Surface opening: Closed  
 Backflex radius: 150.0 mm (5.9 in)  
 Pin diameter: 5.0 mm (0.20 in)

<b>Recommended Belt material &amp; color</b>	POM-LF <b>G</b>	<b>mm</b>	<b>in</b>	<b>mm</b>	<b>in</b>		
<b>Recommended Pin and lock material &amp; color</b>	PP <b>W</b>	<b>P (Nominal)</b>	38.1	1.50	<b>T</b>	8.5	0.33
		<b>L</b>	4.3	0.17	<b>R</b>	7.3	0.29

Non standard material and color: See uni Material and Color Overview.

Alternative materials: Belt: PP and PE Pin: PP **W** PA6.6 **B** PE **W** PBT **LG** and SS304 PP **W** **B** **G** Lockpin: PBT **LG** PA6.6 **N** **D**

Belt width		Permissible tensile force (Belt/pin material)						Belt weight (Belt/pin material)						*Min. No. drive sprocket per shaft	Number of wear strips (Min. No.)	
		POM-D/PP		PP/PP		PE/PP		POM-D/PP		PP/PP		PE/PP			**Carry (pcs)	**Return (pcs)
mm	in	N	lbf	N	lbf	N	lbf	kg/m	lb/ft	kg/m	lb/ft	kg/m	lb/ft			
102	4.0	1046	235	523	118	314	71	0.7	0.49	0.5	0.32	0.5	0.34	2	2	2
153	6.0	1568	353	784	176	470	106	1.1	0.73	0.7	0.47	0.8	0.51	2	2	2
204	8.0	2091	470	1046	235	627	141	1.4	0.97	0.9	0.63	1.0	0.69	2	2	2
255	10.0	2614	588	1307	294	784	176	1.8	1.22	1.2	0.79	1.3	0.86	2	2	2
306	12.0	3137	705	1568	353	941	212	2.2	1.46	1.4	0.95	1.5	1.03	3	3	2
357	14.1	3659	823	1830	411	1098	247	2.5	1.70	1.6	1.10	1.8	1.20	3	3	2
408	16.1	4182	940	2091	470	1255	282	2.9	1.95	1.9	1.26	2.0	1.37	3	3	2
459	18.1	4705	1058	2352	529	1411	317	3.3	2.19	2.1	1.42	2.3	1.54	4	4	2
510	20.1	5228	1175	2614	588	1568	353	3.6	2.43	2.3	1.58	2.6	1.71	4	4	2
561	22.1	5750	1293	2875	646	1725	388	4.0	2.68	2.6	1.73	2.8	1.89	4	4	2
612	24.1	6273	1410	3137	705	1882	423	4.3	2.92	2.8	1.89	3.1	2.06	5	5	3
663	26.1	6796	1528	3398	764	2039	458	4.7	3.16	3.0	2.05	3.3	2.23	5	5	3
714	28.1	7319	1645	3659	823	2196	494	5.1	3.41	3.3	2.21	3.6	2.40	5	5	3

Additional standard belt widths are available in steps of 50.9 mm (2.00 in). Additional non-standard belt widths are available in steps of 12.7 mm (0.50 in).

1987	78.2	20367	4578	10183	2289	6110	1374	14.1	9.48	9.1	6.14	9.9	6.68	14	14	7
------	------	-------	------	-------	------	------	------	------	------	-----	------	-----	------	----	----	---

Additional standard belt widths are available in steps of 50.9 mm (2.00 in). Additional non-standard belt widths are available in steps of 12.7 mm (0.50 in).

2955	116.3	30289	6809	15144	3404	9087	2043	21.0	14.10	13.6	9.14	14.8	9.93	20	20	10
------	-------	-------	------	-------	------	------	------	------	-------	------	------	------	------	----	----	----

General belt tolerance is +0/-0.4% at 23°C/73°F and 50% RH. For exact belt width contact Customer Service. Non standard belt width on request.

\*Max. Load per Drive Sprocket. Belt material: POM-D 1000 N (225 lbf). PP 600 N (135 lbf). PE 600 N (135 lbf).

\*\*Max. Spacing between wear strips. Carry: 152.0 mm (6.00 in); Return: 304.0 mm (12.00 in).

= Single Link



NON STANDARD

STRAIGHT RUNNING

PITCH 38.1 MM/1.50 IN

## Accessories

### Tab

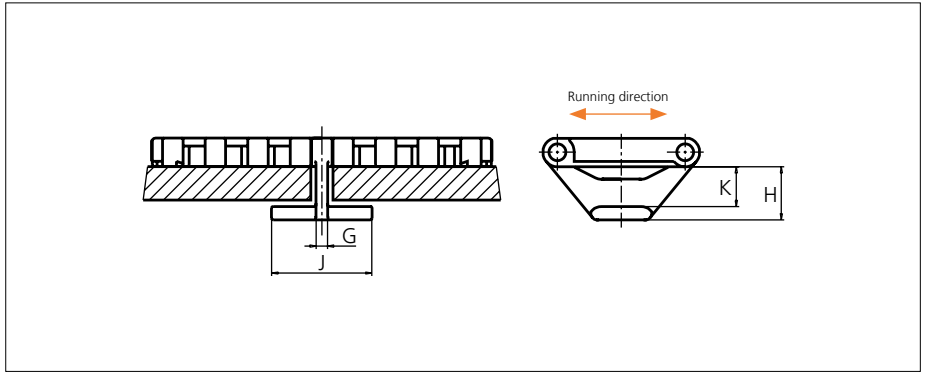

Type	Recommended Material & color	G		J		K		H	
		mm	in	mm	in	mm	in	mm	in
Bottom Hold Down	POM-D	3.5	0.14	26.0	1.02	12.4	0.49	16.4	0.65

Other Non Standard material and color: See uni Material and Color Overview.

## Accessories

### Finger Plates

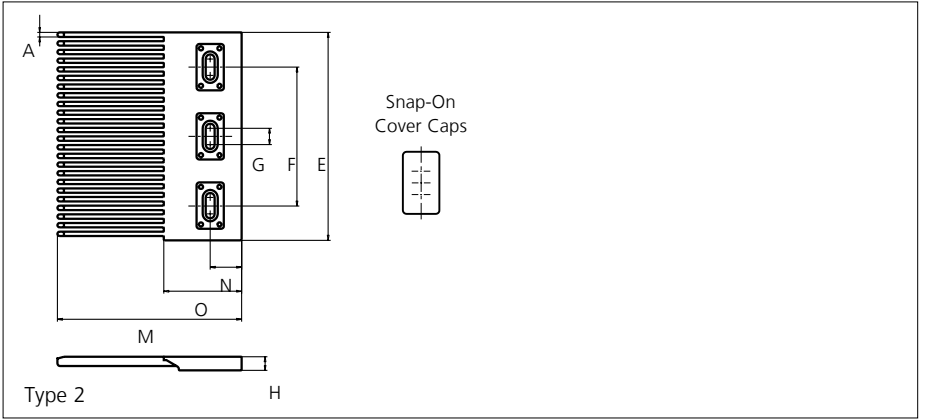
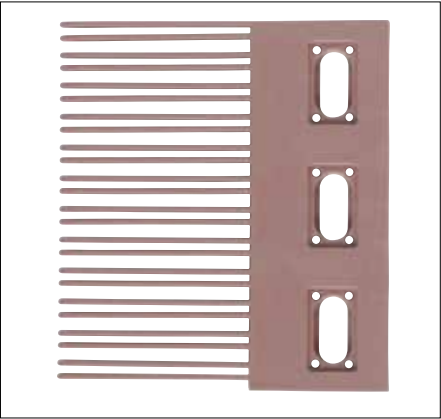

Type	Recommended Material & color	A		E		F		G		H		M		N		O	
		mm	in	mm	in	mm	in	mm	in	mm	in	mm	in	mm	in	mm	in
Single Sided	POM-LF	3.3	0.13	152.4	6.00	101.6	4.00	12.0	0.47	10.3	0.41	135.0	5.31	23.0	0.91	57.0	2.24

All uni-chains belt systems are available in a raised rib version that can be supplied with matching finger plates, also called combs.

The finger plates are supplied with cover caps which can be attached when the finger plate has been installed. The cover caps can be removed by using a screwdriver that can be inserted between the cover and finger plate.

Non Standard material and color: See uni Material and Color Overview.



## Sprocket

No of teeth	Bore size						Overall diameter		Pitch-diameter		Hub-diameter		Dimension A		Dimension B		Single row/Two way	Molded	PA6 LG
	Pilot bore	1.00	1.18	1.25	1.50	1.57													
	mm	25.4	30.0	31.8	38.1	40.0	mm	in	mm	in	mm	in	mm	in	mm	in			
Z07		●	●	●			87.8	3.46	86.0	3.39	65.0	2.56	35.2	1.39	48.3	1.90	✓	✓	
Z09		●	●	●	■	●	111.4	4.39	110.6	4.35	90.0	3.54	48.0	1.89	60.0	2.36	✓	✓	
Z10		●	●	●	■	●	123.3	4.85	122.7	4.83	100.0	3.94	54.3	2.14	66.0	2.60	✓	✓	
Z11		●	●	●	■	●	135.2	5.32	135.0	5.31	110.0	4.33	60.5	2.38	72.0	2.83	✓	✓	
Z12			●	●	●	●	147.2	5.80	147.1	5.79	120.0	4.72	66.7	2.63	78.0	3.07	✓	✓	
Z15			●	●	●	●	183.2	7.21	183.5	7.22	120.0	4.72	85.3	3.36	96.0	3.78	✓	✓	

■ Molded sprocket

● Molded sprocket

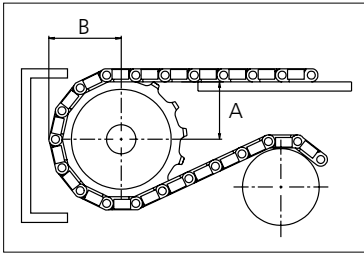
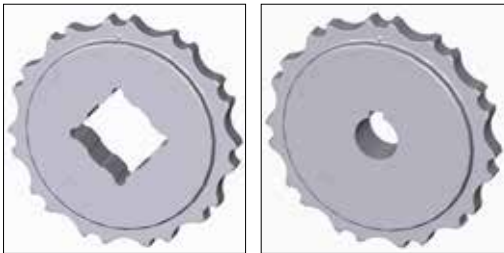

Other sprocket sizes are available upon request.

Two-part sprocket are available upon request.

Other bore sizes are available upon request.

uni Retainer Rings: See uni Retainer Ring data sheet

Width of tooth = 11.8 mm (0.47 in)

Width of sprocket = 23.2 mm (0.91 in)

Max load per sprocket shown does not take bore size into account.

Please also ensure that sufficient size shaft is chosen for corresponding load.

For correct sprocket position: See uni Assembly Instructions for uni Light EP.

For more detailed sprocket information, contact Customer Service.

Non standard material and color: See uni Material and Color Overview.



Conveyor Belts



Seamless Belts

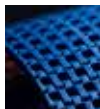

Modular Belts



Timing Belts

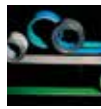

Transmission Belts



Fabrication & service

Solid advice  
For all your belting needs  
Local stock & service  
[www.ammeraalbeltech.com](http://www.ammeraalbeltech.com)

**Ammeraal Beltech Modular A/S**  
Hjulmagervej 21  
DK-7100 Vejle

T +45 7572 3100  
F +45 7572 3348  
admin@unichains.com  
www.unichains.com

This information is subject to alteration due to continuous development. Ammeraal Beltech will not be held liable for the incorrect use of the above stated information. This information replaces previous information. All activities performed and services rendered by Ammeraal Beltech are subject to general terms and conditions of sale and delivery, as applied by its operating companies.



# Plastic Modular Belt

Serie **uni Light EP** Type **8.5%**

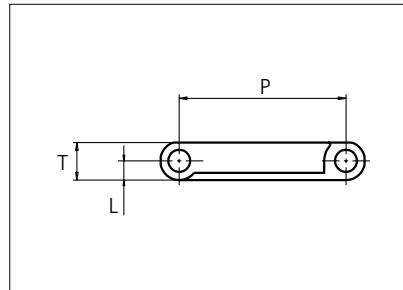

Straight running belt  
 Nominal pitch: 38.1 mm (1.50 in)  
 Surface type: Flat  
 Surface opening: 8.5%  
 Backflex radius: 75.0 mm (3.0 in)  
 Pin diameter: 5.0 mm (0.20 in)

<b>Recommended Belt material &amp; color</b>	POM-D		<b>mm</b>	<b>in</b>		<b>mm</b>	<b>in</b>	
<b>Recommended Pin and lock material &amp; color</b>	PP		<b>P (Nominal)</b>	38.1	1.50	<b>T</b>	8.5	0.33
			<b>L</b>	4.3	0.17	-	-	-

Non standard material and color: See uni Material and Color Overview.

Alternative materials: Belt: PP and PE Pin: PP PA6.6 PE PBT and SS304 PP PP

Lockpin: PBT PA6.6

Belt width		Permissible tensile force (Belt/pin material)						Belt weight (Belt/pin material)						*Min. No. drive sprocket per shaft	Number of wear strips (Min. No.)	
		POM-D/PP		PP/PP		PE/PP		POM-D/PP		PP/PP		PE/PP			**Carry (pcs)	**Return (pcs)
mm	in	N	lbf	N	lbf	N	lbf	kg/m	lb/ft	kg/m	lb/ft	kg/m	lb/ft			
102	4.0	1046	235	523	118	314	71	0.6	0.39	0.4	0.25	0.4	0.27	2	2	2
153	6.0	1568	353	784	176	470	106	0.9	0.59	0.6	0.38	0.6	0.41	2	2	2
204	8.0	2091	470	1046	235	627	141	1.2	0.78	0.8	0.51	0.8	0.55	2	2	2
255	10.0	2614	588	1307	294	784	176	1.5	0.98	0.9	0.63	1.0	0.69	2	2	2
306	12.0	3137	705	1568	353	941	212	1.7	1.17	1.1	0.76	1.2	0.82	3	3	2
357	14.1	3659	823	1830	411	1098	247	2.0	1.37	1.3	0.89	1.4	0.96	3	3	2
408	16.1	4182	940	2091	470	1255	282	2.3	1.56	1.5	1.01	1.6	1.10	3	3	2
459	18.1	4705	1058	2352	529	1411	317	2.6	1.76	1.7	1.14	1.8	1.23	4	4	2
510	20.1	5228	1175	2614	588	1568	353	2.9	1.95	1.9	1.27	2.0	1.37	4	4	2
561	22.1	5750	1293	2875	646	1725	388	3.2	2.15	2.1	1.39	2.2	1.51	4	4	2
612	24.1	6273	1410	3137	705	1882	423	3.5	2.34	2.3	1.52	2.4	1.65	5	5	3
663	26.1	6796	1528	3398	764	2039	458	3.8	2.54	2.5	1.65	2.7	1.78	5	5	3
714	28.1	7319	1645	3659	823	2196	494	4.1	2.74	2.6	1.78	2.9	1.92	5	5	3

Additional standard belt widths are available in steps of 50.9 mm (2.00 in). Additional non-standard belt widths are available in steps of 12.7 mm (0.50 in).

1987	78.2	20367	4578	10183	2289	6110	1374	11.3	7.61	7.4	4.94	7.9	5.34	14	14	7
------	------	-------	------	-------	------	------	------	------	------	-----	------	-----	------	----	----	---

Additional standard belt widths are available in steps of 50.9 mm (2.00 in). Additional non-standard belt widths are available in steps of 12.7 mm (0.50 in).

2955	116.3	30289	6809	15144	3404	9087	2043	16.8	11.32	10.9	7.35	11.8	7.94	20	20	10
------	-------	-------	------	-------	------	------	------	------	-------	------	------	------	------	----	----	----

General belt tolerance is +0/-0.4% at 23°C/73°F and 50% RH. For exact belt width contact Customer Service. Non standard belt width on request.

\*Max. Load per Drive Sprocket. Belt material: POM-D 1000 N (225 lbf). PP 600 N (135 lbf). PE 600 N (135 lbf)

\*\*Max. Spacing between wear strips. Carry: 152.0 mm (6.00 in); Return: 304.0 mm (12.00 in)

= Single Link



NON STANDARD

STRAIGHT RUNNING

PITCH 38.1 MM/1.50 IN

## Accessories

### Flight

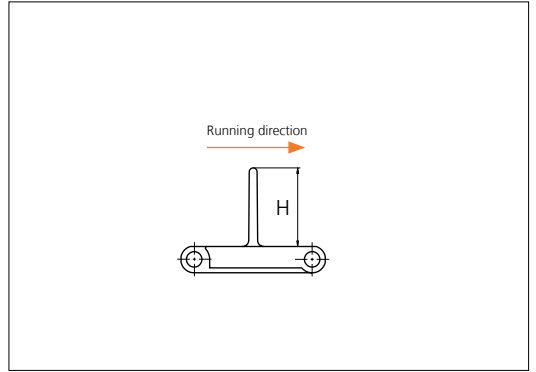

Type	Recommended Material & color	H		Link size	Width		Indent left/right	
		mm	in		mm	in	mm	in
Non Stick	POM-D <b>W</b>	25.4	1.00	K750	191.0	7.52	0.0	0.00
		50.8	2.00				17.5	0.69
Non Stick/ Support Ribs	POM-D <b>W</b>	25.4	1.00	K400	101.6	4.00	0.0	0.00
				K600	152.8	6.02	0.0	0.00
		50.8	2.00	K400	101.6	4.00	0.0	0.00
				K600	152.8	6.02	0.0	0.00
76.2	3.00	K600	152.8	6.02	0.0	0.00		

Minimum bricklaid indent for uni Light EP flights is 38.1 mm (1.50 in), increment: 12.7 mm (0.50 in).

Alternative materials: PP-I, PE

Non Standard material and color: See uni Material and Color Overview.

## Accessories

### Side Guard

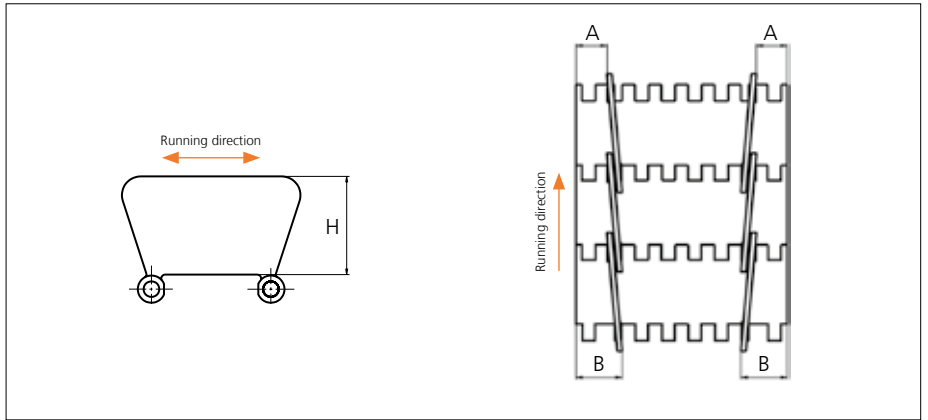



Type	Recommended Material & color	H		A		B	
		mm	in	mm	in	mm	in
Closed	POM-D <b>W</b>	31.7	1.25	15.0	0.59	23.0	0.91

Other Non Standard material and color: See uni Material and Color Overview.

## Accessories

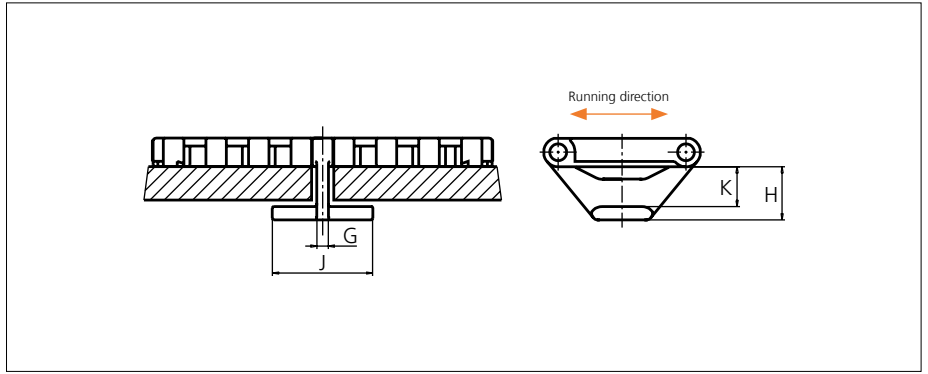
### Tab



Type	Recommended Material & color	G		J		K		H	
		mm	in	mm	in	mm	in	mm	in
Bottom Hold Down	POM-D 	3.5	0.14	26.0	1.02	12.4	0.49	16.4	0.65

Other Non Standard material and color: See uni Material and Color Overview.

## Accessories

### Non Standard uni AmFlight

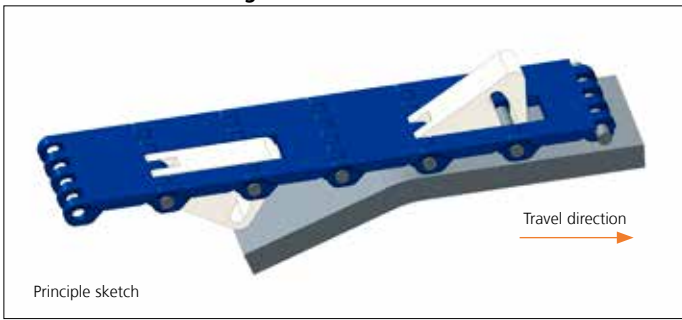

Other Non Standard option: See uni AmFlight Overview.

## Sprocket

No of teeth	Bore size						Overall diameter		Pitch-diameter		Hub-diameter		Dimension A		Dimension B		Single row/Two way	Molded	LG
	Pilot bore	in	1.00	1.18	1.25	1.50													
	mm	25.4	30.0	31.8	38.1	40.0	mm	in	mm	in	mm	in	mm	in	mm	in			
Z07		●	●	●			87.8	3.46	86.0	3.39	65.0	2.56	35.2	1.39	48.3	1.90	✓	✓	
Z09		●	●	●	■	●	111.4	4.39	110.6	4.35	90.0	3.54	48.0	1.89	60.0	2.36	✓	✓	
Z10		●	●	●	■	●	123.3	4.85	122.7	4.83	100.0	3.94	54.3	2.14	66.0	2.60	✓	✓	
Z11		●	●	●	■	●	135.2	5.32	135.0	5.31	110.0	4.33	60.5	2.38	72.0	2.83	✓	✓	
Z12			●	●	●	●	147.2	5.80	147.1	5.79	120.0	4.72	66.7	2.63	78.0	3.07	✓	✓	
Z15			●	●	●	●	183.2	7.21	183.5	7.22	120.0	4.72	85.3	3.36	96.0	3.78	✓	✓	

■ Molded sprocket ● Molded sprocket

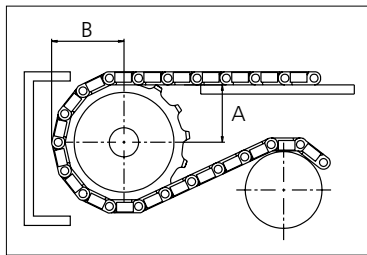
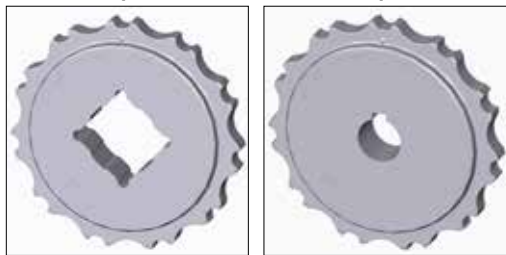

Other sprocket sizes are available upon request.  
 Two-part sprocket are available upon request.  
 Other bore sizes are available upon request.  
 uni Retainer Rings: See uni Retainer Ring data sheet  
 Width of tooth = 11.8 mm (0.47 in)  
 Width of sprocket = 23.2 mm (0.91 in)

Max load per sprocket shown does not take bore size into account.  
 Please also ensure that sufficient size shaft is chosen for corresponding load.

For correct sprocket position: See uni Assembly Instructions for uni Light EP.  
 For more detailed sprocket information. contact Customer Service.

Non standard material and color: See uni Material and Color Overview.

uni Light EP 8.5%/2019.05.29



*Solid advice*  
 For all your belting needs  
 Local stock & service  
[www.ammeraalbeltech.com](http://www.ammeraalbeltech.com)

**Ammeraal Beltech Modular A/S**  
 Hjulmagervej 21  
 DK-7100 Vejle

T +45 7572 3100  
 F +45 7572 3348  
 admin@unichains.com  
 www.unichains.com

This information is subject to alteration due to continuous development. Ammeraal Beltech will not be held liable for the incorrect use of the above stated information. This information replaces previous information. All activities performed and services rendered by Ammeraal Beltech are subject to general terms and conditions of sale and delivery, as applied by its operating companies.



# Plastic Modular Belt

Serie **uni Light EP** Type **18%**

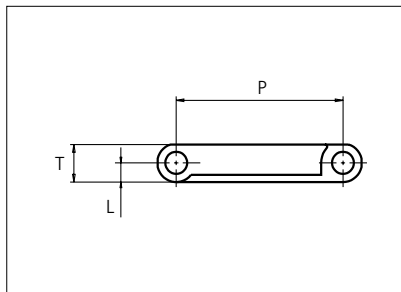

Straight running belt  
 Nominal pitch: 38.1 mm (1.50 in)  
 Surface type: Flat  
 Surface opening: 18%  
 Backflex radius: 75.0 mm (3.0 in)  
 Pin diameter: 5.0 mm (0.20 in)

<b>Recommended Belt material &amp; color</b>	POM-D	<b>mm</b>	<b>in</b>		<b>mm</b>	<b>in</b>	
<b>Recommended Pin and lock material &amp; color</b>	PP	<b>P (Nominal)</b>	38.1	1.50	<b>T</b>	8.5	0.33
		<b>L</b>	4.3	0.17	-	-	-

Non standard material and color: See uni Material and Color Overview.

Alternative materials: Belt: PP and PE Pin: PP PA6.6 PE PBT and SS304 PP PP

Lockpin: PBT PA6.6

Belt width		Permissible tensile force (Belt/pin material)						Belt weight (Belt/pin material)						*Min. No. drive sprocket per shaft	Number of wear strips (Min. No.)	
		POM-D/PP		PP/PP		PE/PP		POM-D/PP		PP/PP		PE/PP			**Carry (pcs)	**Return (pcs)
mm	in	N	lbf	N	lbf	N	lbf	kg/m	lb/ft	kg/m	lb/ft	kg/m	lb/ft			
102	4.0	1046	235	523	118	314	71	0.5	0.33	0.3	0.23	0.4	0.25	2	2	2
153	6.0	1568	353	784	176	470	106	0.7	0.49	0.5	0.35	0.6	0.37	2	2	2
204	8.0	2091	470	1046	235	627	141	1.0	0.66	0.7	0.47	0.7	0.49	2	2	2
255	10.0	2614	588	1307	294	784	176	1.2	0.82	0.9	0.58	0.9	0.62	2	2	2
306	12.0	3137	705	1568	353	941	212	1.5	0.99	1.0	0.70	1.1	0.74	3	3	2
357	14.1	3659	823	1830	411	1098	247	1.7	1.15	1.2	0.82	1.3	0.86	3	3	2
408	16.1	4182	940	2091	470	1255	282	2.0	1.32	1.4	0.93	1.5	0.99	3	3	2
459	18.1	4705	1058	2352	529	1411	317	2.2	1.48	1.6	1.05	1.7	1.11	4	4	2
510	20.1	5228	1175	2614	588	1568	353	2.4	1.65	1.7	1.17	1.8	1.23	4	4	2
561	22.1	5750	1293	2875	646	1725	388	2.7	1.81	1.9	1.28	2.0	1.36	4	4	2
612	24.1	6273	1410	3137	705	1882	423	2.9	1.97	2.1	1.40	2.2	1.48	5	5	3
663	26.1	6796	1528	3398	764	2039	458	3.2	2.14	2.3	1.51	2.4	1.60	5	5	3
714	28.1	7319	1645	3659	823	2196	494	3.4	2.30	2.4	1.63	2.6	1.73	5	5	3

Additional standard belt widths are available in steps of 50.9 mm (2.00 in). Additional non-standard belt widths are available in steps of 12.7 mm (0.50 in).

1987	78.2	20367	4578	10183	2289	6110	1374	9.5	6.41	6.8	4.54	7.2	4.81	14	14	7
------	------	-------	------	-------	------	------	------	-----	------	-----	------	-----	------	----	----	---

Additional standard belt widths are available in steps of 50.9 mm (2.00 in). Additional non-standard belt widths are available in steps of 12.7 mm (0.50 in).

2955	116.3	30289	6809	15144	3404	9087	2043	14.2	9.53	10.0	6.75	10.6	7.15	20	20	10
------	-------	-------	------	-------	------	------	------	------	------	------	------	------	------	----	----	----

General belt tolerance is +0/-0.4% at 23°C/73°F and 50% RH. For exact belt width contact Customer Service. Non standard belt width on request.

\*Max. Load per Drive Sprocket. Belt material: POM-D 1000 N (225 lbf). PP 600 N (135 lbf). PE 600 N (135 lbf)

\*\*Max. Spacing between wear strips. Carry: 152.0 mm (6.00 in); Return: 304.0 mm (12.00 in)

= Single Link



NON STANDARD

STRAIGHT RUNNING

PITCH 38.1 MM/1.50 IN

## Accessories

### Flight

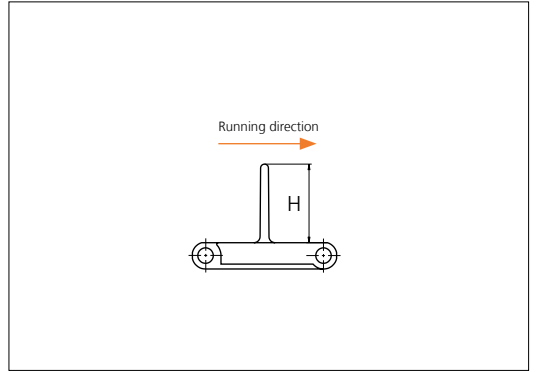
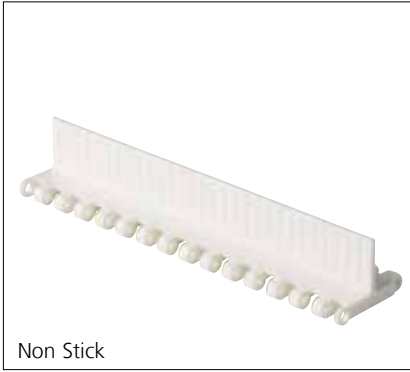

Type	Recommended Material & color	H		Link size	Width		Indent left/right	
		mm	in		mm	in	mm	in
Non Stick	POM-D <b>W</b>	25.4	1.00	K750	191.0	7.52	0.0	0.00
		50.8	2.00				17.5	0.69
Non Stick/ Support Ribs	POM-D <b>W</b>	25.4	1.00	K400	101.6	4.00	0.0	0.00
				K600	152.8	6.02	0.0	0.00
		50.8	2.00	K400	101.6	4.00	0.0	0.00
				K600	152.8	6.02	0.0	0.00
76.2	3.00	K600	152.8	6.02	0.0	0.00		

Minimum bricklaid indent for uni Light EP flights is 38.1 mm (1.50 in), increment: 12.7 mm (0.50 in).

Alternative materials: PP-I, PE.

Non Standard material and color: See uni Material and Color Overview.

## Accessories

### Side Guard

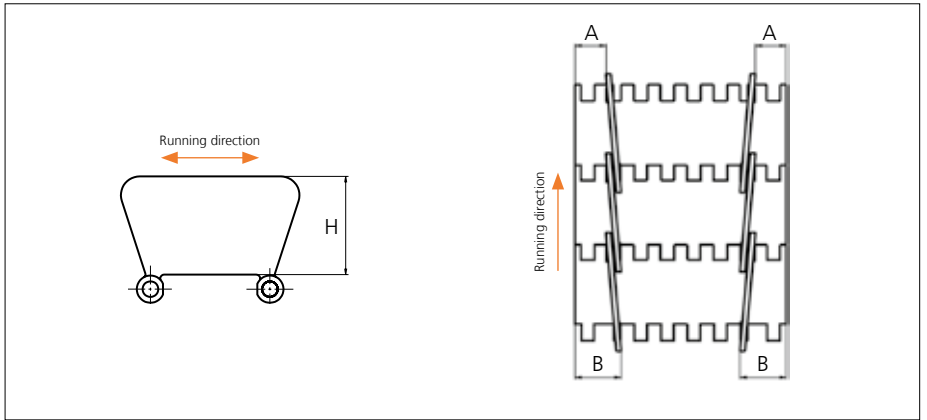

Type	Recommended Material & color	H		A		B	
		mm	in	mm	in	mm	in
Closed	POM-D <b>W</b>	31.7	1.25	15.0	0.59	23.0	0.91

Other Non Standard material and color: See uni Material and Color Overview.



## Accessories

### Tab

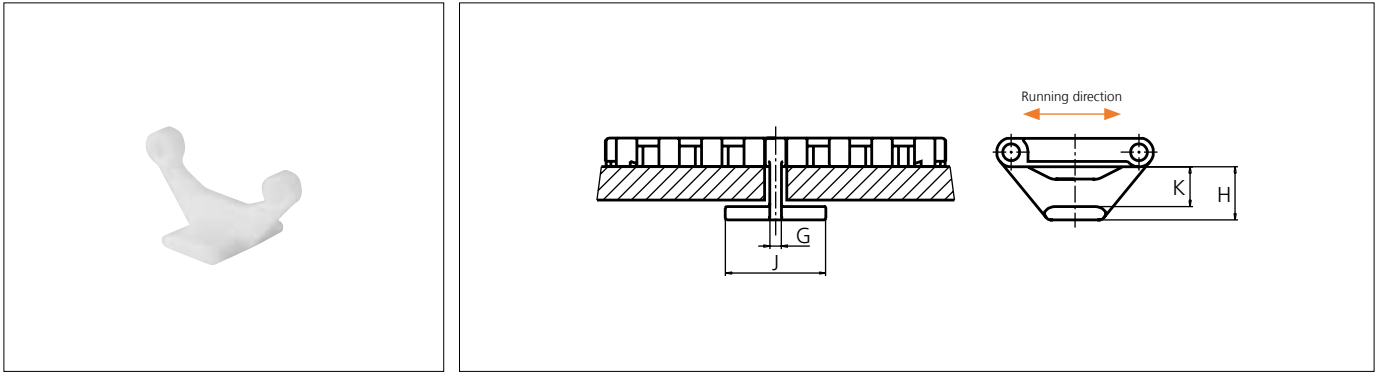

Type	Recommended Material & color	G		J		K		H	
		mm	in	mm	in	mm	in	mm	in
Bottom Hold Down	POM-D 	3.5	0.14	26.0	1.02	12.4	0.49	16.4	0.65

Other Non Standard material and color: See uni Material and Color Overview.

## Accessories

### Non Standard uni AmFlight

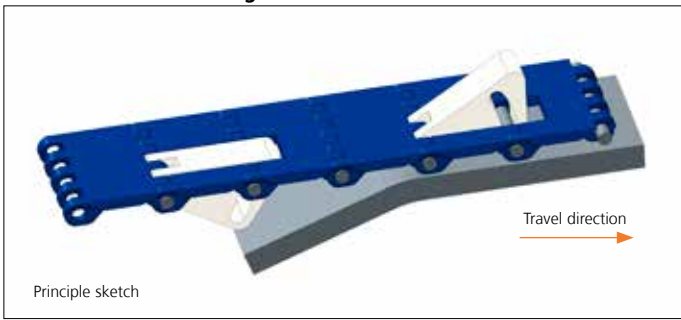

Other Non Standard option: See uni AmFlight Overview.

## Sprocket

No of teeth	Bore size						Overall diameter		Pitch-diameter		Hub-diameter		Dimension A		Dimension B		Single row/Two way	Molded	PA6 LG
	Pilot bore	in	1.00	1.18	1.25	1.50													
	mm	25.4	30.0	31.8	38.1	40.0	mm	in	mm	in	mm	in	mm	in	mm	in			
Z07			●	●	●			87.8	3.46	86.0	3.39	65.0	2.56	35.2	1.39	48.3	1.90	✓	✓
Z09			●	●	●	■	●	111.4	4.39	110.6	4.35	90.0	3.54	48.0	1.89	60.0	2.36	✓	✓
Z10			●	●	●	■	■	123.3	4.85	122.7	4.83	100.0	3.94	54.3	2.14	66.0	2.60	✓	✓
Z11			●	●	●	■	■	135.2	5.32	135.0	5.31	110.0	4.33	60.5	2.38	72.0	2.83	✓	✓
Z12				●	●	●	●	147.2	5.80	147.1	5.79	120.0	4.72	66.7	2.63	78.0	3.07	✓	✓
Z15				●	●	●	●	183.2	7.21	183.5	7.22	120.0	4.72	85.3	3.36	96.0	3.78	✓	✓

■ Molded sprocket ● Molded sprocket

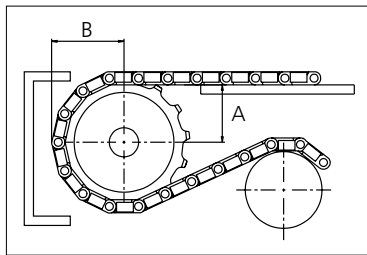
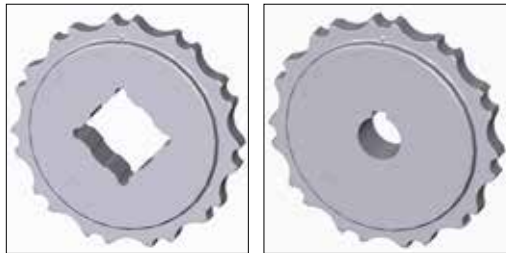

Other sprocket sizes are available upon request.  
 Two-part sprocket are available upon request.  
 Other bore sizes are available upon request.  
 uni Retainer Rings: See uni Retainer Ring data sheet  
 Width of tooth = 11.8 mm (0.47 in)  
 Width of sprocket = 23.2 mm (0.91 in)

Max load per sprocket shown does not take bore size into account.  
 Please also ensure that sufficient size shaft is chosen for corresponding load.

For correct sprocket position: See uni Assembly Instructions for uni Light EP.  
 For more detailed sprocket information. contact Customer Service.

Non standard material and color: See uni Material and Color Overview.

uni Light EP 18%/2019.05.29



*Solid advice*  
 For all your belting needs  
 Local stock & service  
[www.ammeraalbeltech.com](http://www.ammeraalbeltech.com)

**Ammeraal Beltech Modular A/S**  
 Hjulmagervej 21  
 DK-7100 Vejle

T +45 7572 3100  
 F +45 7572 3348  
 admin@unichains.com  
 www.unichains.com

This information is subject to alteration due to continuous development. Ammeraal Beltech will not be held liable for the incorrect use of the above stated information. This information replaces previous information. All activities performed and services rendered by Ammeraal Beltech are subject to general terms and conditions of sale and delivery, as applied by its operating companies.



# Plastic Modular Belt

Serie **uni Light EP** Type **22%**

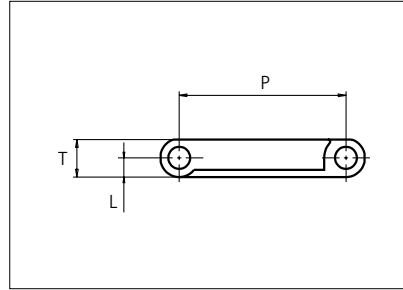
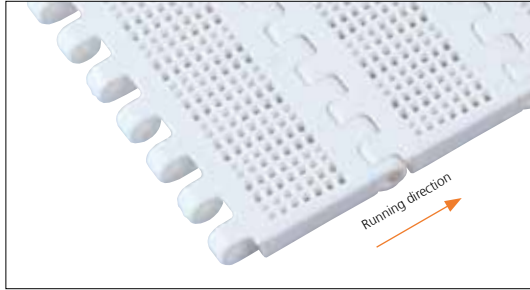

Straight running belt  
 Nominal pitch: 38.1 mm (1.50 in)  
 Surface type: Flat  
 Surface opening: 22%  
 Backflex radius: 75.0 mm (3.0 in)  
 Pin diameter: 5.0 mm (0.20 in)

<b>Recommended Belt material &amp; color</b>	POM-D	<b>mm</b>	<b>in</b>		<b>mm</b>	<b>in</b>	
<b>Recommended Pin and lock material &amp; color</b>	PP	<b>P (Nominal)</b>	38.1	1.50	<b>T</b>	8.5	0.33
		<b>L</b>	4.3	0.17	-	-	-

Non standard material and color: See uni Material and Color Overview.

Alternative materials: Belt: PP and PE Pin: PP PA6.6 PE PBT and SS304 PP PP

Lockpin: PBT PA6.6

Belt width		Permissible tensile force (Belt/pin material)						Belt weight (Belt/pin material)						*Min. No. drive sprocket per shaft	Number of wear strips (Min. No.)	
		POM-D/PP		PP/PP		PE/PP		POM-D/PP		PP/PP		PE/PP			**Carry (pcs)	**Return (pcs)
mm	in	N	lbf	N	lbf	N	lbf	kg/m	lb/ft	kg/m	lb/ft	kg/m	lb/ft			
102	4.0	1046	235	523	118	314	71	0.5	0.33	0.3	0.23	0.4	0.25	2	2	2
153	6.0	1568	353	784	176	470	106	0.7	0.49	0.5	0.35	0.6	0.37	2	2	2
204	8.0	2091	470	1046	235	627	141	1.0	0.66	0.7	0.47	0.7	0.49	2	2	2
255	10.0	2614	588	1307	294	784	176	1.2	0.82	0.9	0.58	0.9	0.62	2	2	2
306	12.0	3137	705	1568	353	941	212	1.5	0.99	1.0	0.70	1.1	0.74	3	3	2
357	14.1	3659	823	1830	411	1098	247	1.7	1.15	1.2	0.82	1.3	0.86	3	3	2
408	16.1	4182	940	2091	470	1255	282	2.0	1.32	1.4	0.93	1.5	0.99	3	3	2
459	18.1	4705	1058	2352	529	1411	317	2.2	1.48	1.6	1.05	1.7	1.11	4	4	2
510	20.1	5228	1175	2614	588	1568	353	2.4	1.65	1.7	1.17	1.8	1.23	4	4	2
561	22.1	5750	1293	2875	646	1725	388	2.7	1.81	1.9	1.28	2.0	1.36	4	4	2
612	24.1	6273	1410	3137	705	1882	423	2.9	1.97	2.1	1.40	2.2	1.48	5	5	3
663	26.1	6796	1528	3398	764	2039	458	3.2	2.14	2.3	1.51	2.4	1.60	5	5	3
714	28.1	7319	1645	3659	823	2196	494	3.4	2.30	2.4	1.63	2.6	1.73	5	5	3

Additional standard belt widths are available in steps of 50.9 mm (2.00 in). Additional non-standard belt widths are available in steps of 12.7 mm (0.50 in).

1987	78.2	20367	4578	10183	2289	6110	1374	9.5	6.41	6.8	4.54	7.2	4.81	14	14	7
------	------	-------	------	-------	------	------	------	-----	------	-----	------	-----	------	----	----	---

Additional standard belt widths are available in steps of 50.9 mm (2.00 in). Additional non-standard belt widths are available in steps of 12.7 mm (0.50 in).

2955	116.3	30289	6809	15144	3404	9087	2043	14.2	9.53	10.0	6.75	10.6	7.15	20	20	10
------	-------	-------	------	-------	------	------	------	------	------	------	------	------	------	----	----	----

General belt tolerance is +/-0.4% at 23°C/73°F and 50% RH. For exact belt width contact Customer Service. Non standard belt width on request.

\*Max. Load per Drive Sprocket. Belt material: POM-D 1000 N (225 lbf). PP 600 N (135 lbf). PE 600 N (135 lbf)

\*\*Max. Spacing between wear strips. Carry: 152.0 mm (6.00 in); Return: 304.0 mm (12.00 in).

= Single Link



NON STANDARD

STRAIGHT RUNNING

PITCH 38.1 MM/1.50 IN

## Accessories

### Flight

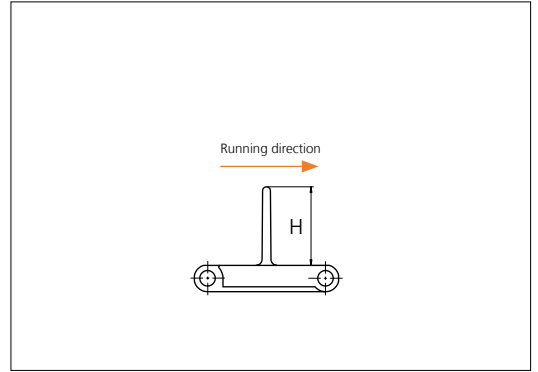

Type	Recommended Material & color	H		Link size	Width		Indent left/right	
		mm	in		mm	in	mm	in
Non Stick	POM-D <b>W</b>	25.4	1.00	K750	191.0	7.52	0.0	0.00
		50.8	2.00				17.5	0.69
Non Stick/ Support Ribs	POM-D <b>W</b>	25.4	1.00	K400	101.6	4.00	0.0	0.00
				K600	152.8	6.02	0.0	0.00
		50.8	2.00	K400	101.6	4.00	0.0	0.00
				K600	152.8	6.02	0.0	0.00

Minimum bricklaid indent for uni Light EP flights is 38.1 mm (1.50 in), increment: 12.7 mm (0.50 in).

Alternative materials: PP-I, PE

Non Standard material and color: See uni Material and Color Overview.

## Accessories

### Side Guard

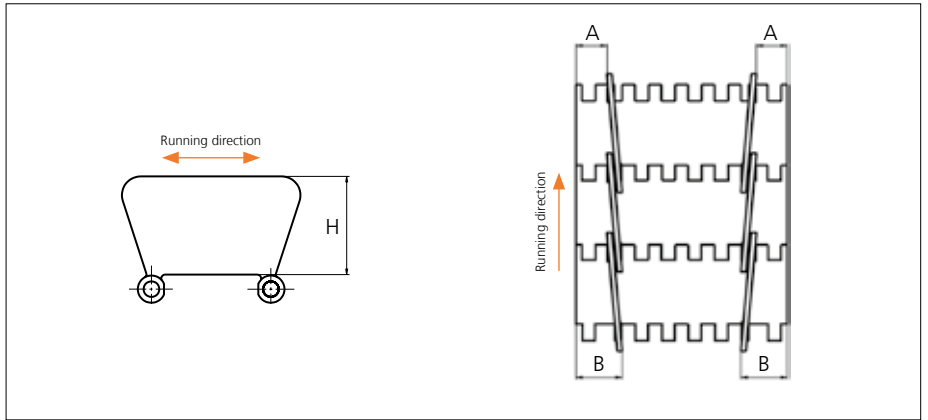



Type	Recommended Material & color	H		A		B	
		mm	in	mm	in	mm	in
Closed	POM-D <b>W</b>	31.7	1.25	15.0	0.59	23.0	0.91

Other Non Standard material and color: See uni Material and Color Overview.

## Accessories

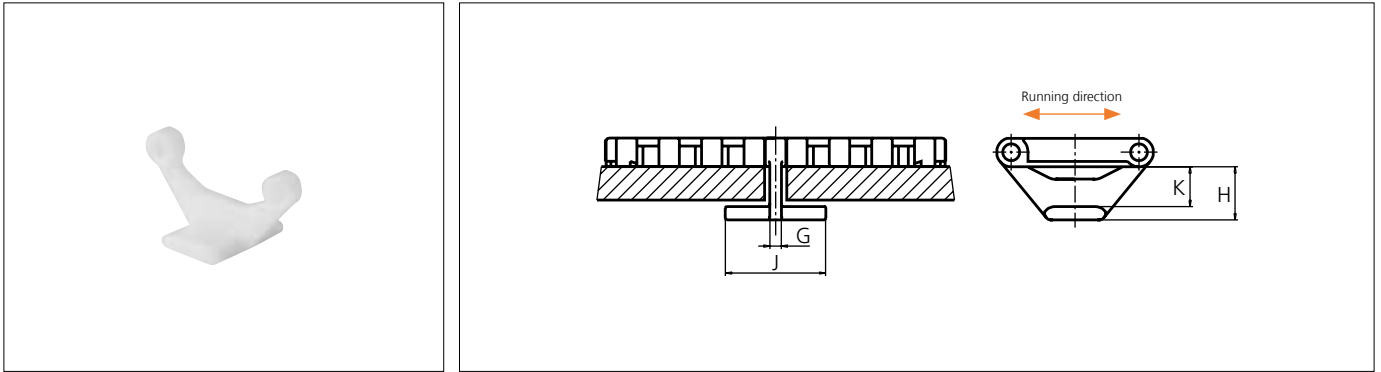
### Tab



Type	Recommended Material & color	G		J		K		H	
		mm	in	mm	in	mm	in	mm	in
Bottom Hold Down	POM-D 	3.5	0.14	26.0	1.02	12.4	0.49	16.4	0.65

Other Non Standard material and color: See uni Material and Color Overview.

## Accessories

### Non Standard uni AmFlight

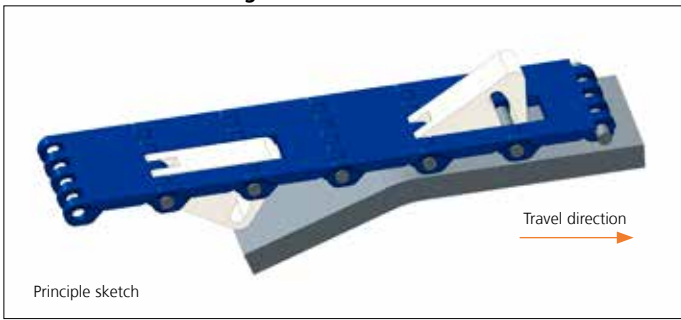

Other Non Standard option: See uni AmFlight Overview.

## Sprocket

No of teeth	Bore size						Overall diameter		Pitch-diameter		Hub-diameter		Dimension A		Dimension B		Single row/Two way	Molded	PA6 LG
	Pilot bore	in	1.00	1.18	1.25	1.50													
	mm	25.4	30.0	31.8	38.1	40.0	mm	in	mm	in	mm	in	mm	in	mm	in			
Z07			●	●	●			87.8	3.46	86.0	3.39	65.0	2.56	35.2	1.39	48.3	1.90	✓	✓
Z09			●	●	●	■	●	111.4	4.39	110.6	4.35	90.0	3.54	48.0	1.89	60.0	2.36	✓	✓
Z10			●	●	●	■	●	123.3	4.85	122.7	4.83	100.0	3.94	54.3	2.14	66.0	2.60	✓	✓
Z11			●	●	●	■	●	135.2	5.32	135.0	5.31	110.0	4.33	60.5	2.38	72.0	2.83	✓	✓
Z12				●	●	●	●	147.2	5.80	147.1	5.79	120.0	4.72	66.7	2.63	78.0	3.07	✓	✓
Z15				●	●	●	●	183.2	7.21	183.5	7.22	120.0	4.72	85.3	3.36	96.0	3.78	✓	✓

■ Molded sprocket ● Molded sprocket

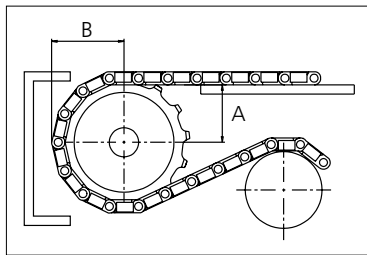
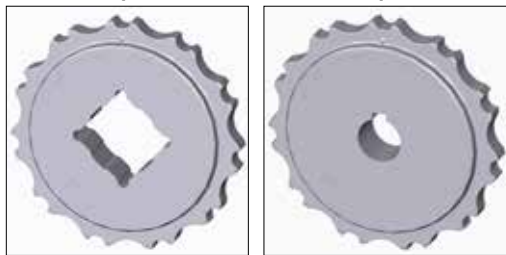

Non standard material and color: See uni Material and Color Overview.

Other sprocket sizes are available upon request.  
 Two-part sprocket are available upon request.  
 Other bore sizes are available upon request.  
 uni Retainer Rings: See uni Retainer Ring data sheet  
 Width of tooth = 11.8 mm (0.47 in)  
 Width of sprocket = 23.2 mm (0.91 in)

Max load per sprocket shown does not take bore size into account.  
 Please also ensure that sufficient size shaft is chosen for corresponding load.

For correct sprocket position: See uni Assembly Instructions for uni Light EP.  
 For more detailed sprocket information. contact Customer Service.

uni Light EP 22%/2019.05.29



Solid advice  
 For all your belting needs  
 Local stock & service  
[www.ammeraalbeltech.com](http://www.ammeraalbeltech.com)

**Ammeraal Beltech Modular A/S**  
 Hjulmagervej 21  
 DK-7100 Vejle

T +45 7572 3100  
 F +45 7572 3348  
 admin@unichains.com  
 www.unichains.com

This information is subject to alteration due to continuous development. Ammeraal Beltech will not be held liable for the incorrect use of the above stated information. This information replaces previous information. All activities performed and services rendered by Ammeraal Beltech are subject to general terms and conditions of sale and delivery, as applied by its operating companies.



# Plastic Modular Belt

Serie **uni Light EP** Type **28%**

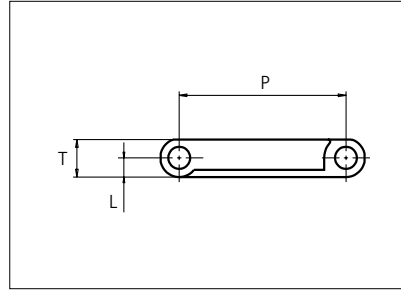

Straight running belt  
 Nominal pitch: 38.1 mm (1.50 in)  
 Surface type: Flat  
 Surface opening: 28%  
 Backflex radius: 75.0 mm (3.0 in)  
 Pin diameter: 5.0 mm (0.20 in)

<b>Recommended Belt material &amp; color</b>	POM-D	<b>mm</b>	<b>in</b>		<b>mm</b>	<b>in</b>	
<b>Recommended Pin and lock material &amp; color</b>	PP	<b>P (Nominal)</b>	38.1	1.50	<b>T</b>	8.5	0.33
		<b>L</b>	4.3	0.17	-	-	-

Non standard material and color: See uni Material and Color Overview.

Alternative materials: Belt: PP and PE Pin: PP PA6.6 PE PBT and SS304 PP PP

Lockpin: PBT PA6.6

Belt width		Permissible tensile force (Belt/pin material)						Belt weight (Belt/pin material)						*Min. No. drive sprocket per shaft	Number of wear strips (Min. No.)	
		POM-D/PP		PP/PP		PE/PP		POM-D/PP		PP/PP		PE/PP			**Carry (pcs)	**Return (pcs)
mm	in	N	lbf	N	lbf	N	lbf	kg/m	lb/ft	kg/m	lb/ft	kg/m	lb/ft			
102	4.0	1046	235	523	118	314	71	0.5	0.33	0.3	0.23	0.4	0.25	2	2	2
153	6.0	1568	353	784	176	470	106	0.7	0.49	0.5	0.35	0.6	0.37	2	2	2
191	7.5	1958	440	979	220	587	132	0.9	0.62	0.6	0.44	0.7	0.46	2	2	2
204	8.0	2091	470	1046	235	627	141	1.0	0.66	0.7	0.47	0.7	0.49	2	2	2
255	10.0	2614	588	1307	294	784	176	1.2	0.82	0.9	0.58	0.9	0.62	2	2	2
306	12.0	3137	705	1568	353	941	212	1.5	0.99	1.0	0.70	1.1	0.74	3	3	2
357	14.1	3659	823	1830	411	1098	247	1.7	1.15	1.2	0.82	1.3	0.86	3	3	2
408	16.1	4182	940	2091	470	1255	282	2.0	1.32	1.4	0.93	1.5	0.99	3	3	2
459	18.1	4705	1058	2352	529	1411	317	2.2	1.48	1.6	1.05	1.7	1.11	4	4	2
510	20.1	5228	1175	2614	588	1568	353	2.4	1.65	1.7	1.17	1.8	1.23	4	4	2
561	22.1	5750	1293	2875	646	1725	388	2.7	1.81	1.9	1.28	2.0	1.36	4	4	2
612	24.1	6273	1410	3137	705	1882	423	2.9	1.97	2.1	1.40	2.2	1.48	5	5	3
663	26.1	6796	1528	3398	764	2039	458	3.2	2.14	2.3	1.51	2.4	1.60	5	5	3

Additional standard belt widths are available in steps of 50.9 mm (2.00 in). Additional non-standard belt widths are available in steps of 12.7 mm (0.50 in).

1987	78.2	20367	4578	10183	2289	6110	1374	9.5	6.41	6.8	4.54	7.2	4.81	14	14	7
------	------	-------	------	-------	------	------	------	-----	------	-----	------	-----	------	----	----	---

Additional standard belt widths are available in steps of 50.9 mm (2.00 in). Additional non-standard belt widths are available in steps of 12.7 mm (0.50 in).

2955	116.3	30289	6809	15144	3404	9087	2043	14.2	9.53	10.0	6.75	10.6	7.15	20	20	10
------	-------	-------	------	-------	------	------	------	------	------	------	------	------	------	----	----	----

General belt tolerance is +0/-0.4% at 23°C/73°F and 50% RH. For exact belt width contact Customer Service. Non standard belt width on request.

\*Max. Load per Drive Sprocket. Belt material: POM-D 1000 N (225 lbf). PP 600 N (135 lbf). PE 600 N (135 lbf)

\*\*Max. Spacing between wear strips. Carry: 152.0 mm (6.00 in); Return: 304.0 mm (12.00 in)

= Single Link



NON STANDARD

STRAIGHT RUNNING

PITCH 38.1 MM/1.50 IN

## Accessories

### Flight

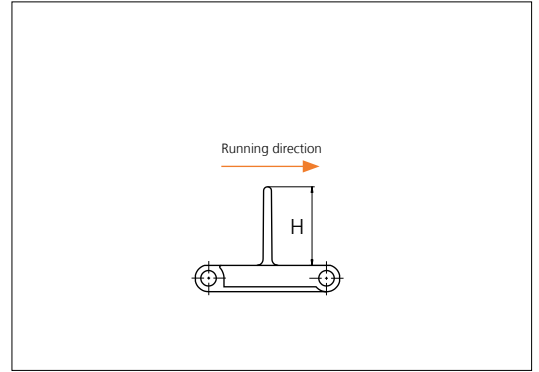

Type	Recommended Material & color	H		Link size	Width		Indent left/right	
		mm	in		mm	in	mm	in
Non Stick	POM-D <b>W</b>	25.4	1.00	K750	191.0	7.52	0.0	0.00
		50.8	2.00				17.5	0.69
Non Stick/ Support Ribs	POM-D <b>W</b>	25.4	1.00	K400	101.6	4.00	0.0	0.00
				K600	152.8	6.02	0.0	0.00
		50.8	2.00	K400	101.6	4.00	0.0	0.00
				K600	152.8	6.02	0.0	0.00
76.2	3.00	K600	152.8	6.02	0.0	0.00		

Minimum bricklaid indent for uni Light EP flights is 38.1 mm (1.50 in), increment: 12.7 mm (0.50 in).

Alternative materials: PP-I, PE.

Non Standard material and color: See uni Material and Color Overview.

## Accessories

### Side Guard

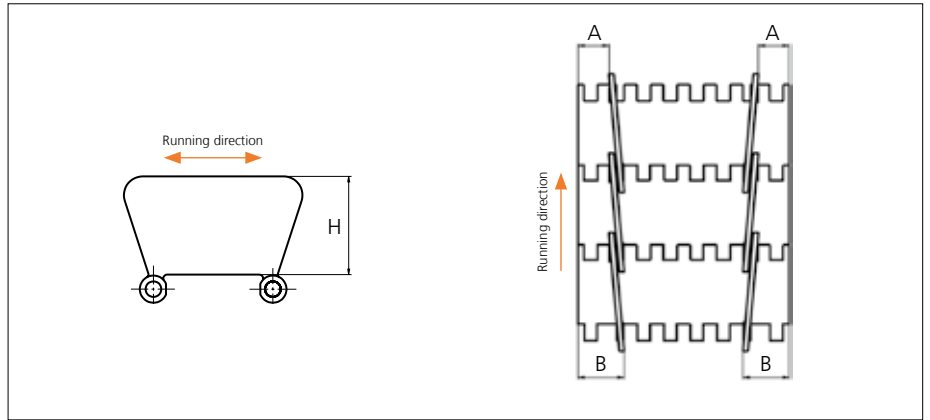

Type	Recommended Material & color	H		A		B	
		mm	in	mm	in	mm	in
Closed	POM-D <b>W</b>	31.7	1.25	15.0	0.59	23.0	0.91

Other Non Standard material and color: See uni Material and Color Overview.



## Accessories

### Tab

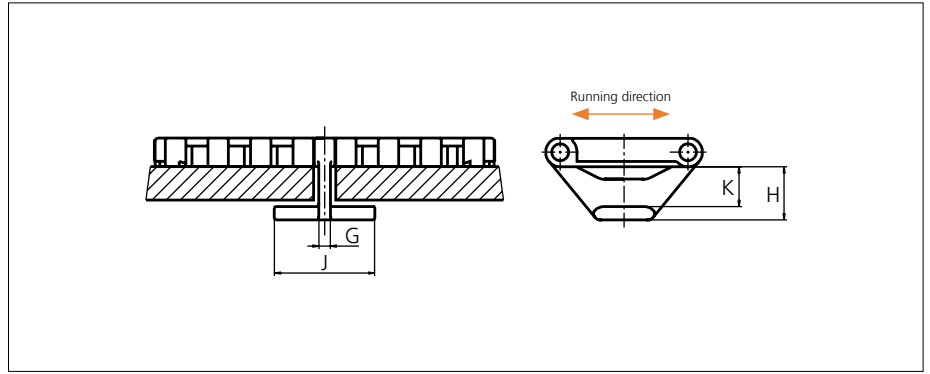

Type	Recommended Material & color	G		J		K		H	
		mm	in	mm	in	mm	in	mm	in
Bottom Hold Down	POM-D	3.5	0.14	26.0	1.02	12.4	0.49	16.4	0.65

Other Non Standard material and color: See uni Material and Color Overview.

## Accessories

### Non Standard uni AmFlight

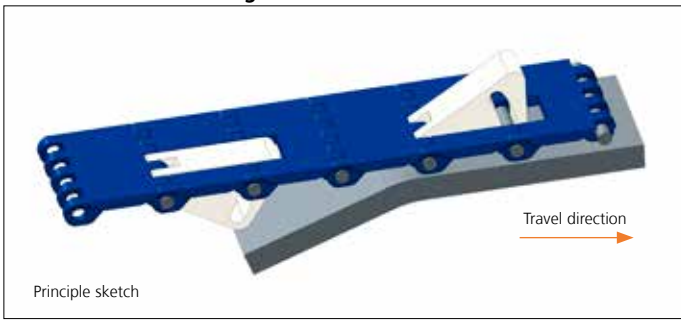

Other Non Standard option: See uni AmFlight Overview.

## Sprocket

No. of teeth	Bore size						Overall diameter		Pitch-diameter		Hub-diameter		Dimension A		Dimension B		Single row/Two way	Molded	PA6 LG
	Pilot bore	in	1.00	1.18	1.25	1.50													
	mm	25.4	30.0	31.8	38.1	40.0	mm	in	mm	in	mm	in	mm	in	mm	in			
Z07		●	●	●			87.8	3.46	86.0	3.39	65.0	2.56	35.2	1.39	48.3	1.90	x	x	
Z09		●	●	●	■	●	111.4	4.39	110.6	4.35	90.0	3.54	48.0	1.89	60.0	2.36	x	x	
Z10		●	●	●	■	●	123.3	4.85	122.7	4.83	100.0	3.94	54.3	2.14	66.0	2.60	x	x	
Z11		●	●	●	■	●	135.2	5.32	135.0	5.31	110.0	4.33	60.5	2.38	72.0	2.83	x	x	
Z12			●	●	●	●	147.2	5.80	147.1	5.79	120.0	4.72	66.7	2.63	78.0	3.07	x	x	
Z15			●	●	●	●	183.2	7.21	183.5	7.22	120.0	4.72	85.3	3.36	96.0	3.78	x	x	

■ Molded sprocket

● Molded sprocket

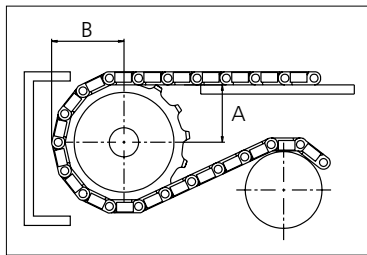
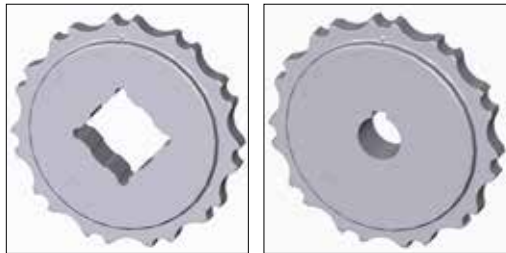

Other sprocket sizes are available upon request.  
 Two-part sprocket are available upon request.  
 Other bore sizes are available upon request.  
 uni Retainer Rings: See uni Retainer Ring data sheet  
 Width of tooth = 11.8 mm (0.47 in)  
 Width of sprocket = 23.2 mm (0.91 in)

Max load per sprocket shown does not take bore size into account.  
 Please also ensure that sufficient size shaft is chosen for corresponding load.

For correct sprocket position: See uni Assembly Instructions for uni Light EP.  
 For more detailed sprocket information, contact Customer Service.

Non standard material and color: See uni Material and Color Overview.

uni Light EP 28%/2019.05.29



Conveyor Belts



Seamless Belts

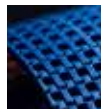

Modular Belts



Timing Belts



Transmission Belts



Fabrication & service

Solid advice  
 For all your belting needs  
 Local stock & service  
[www.ammeraalbeltech.com](http://www.ammeraalbeltech.com)

**Ammeraal Beltech Modular A/S**  
 Hjulmagervej 21  
 DK-7100 Vejle

T +45 7572 3100  
 F +45 7572 3348  
 admin@unichains.com  
 www.unichains.com

This information is subject to alteration due to continuous development. Ammeraal Beltech will not be held liable for the incorrect use of the above stated information. This information replaces previous information. All activities performed and services rendered by Ammeraal Beltech are subject to general terms and conditions of sale and delivery, as applied by its operating companies.



# Plastic Modular Belt

Serie **uni Light EP** Type **33%**

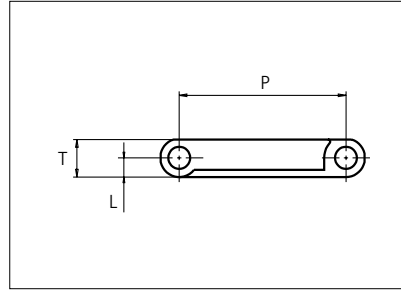
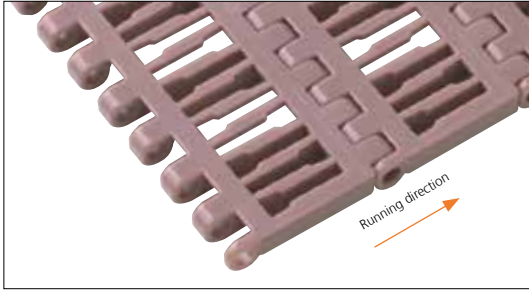

Straight running belt  
 Nominal pitch: 38.1 mm (1.50 in)  
 Surface type: Flat  
 Surface opening: 33%  
 Backflex radius: 75.0 mm (3.0 in)  
 Pin diameter: 5.0 mm (0.20 in)

<b>Recommended Belt material &amp; color</b>	POM-LF <b>BR</b>	<b>mm</b>	<b>in</b>	<b>mm</b>	<b>in</b>		
<b>Recommended Pin and lock material &amp; color</b>	PP <b>W</b>	<b>P (Nominal)</b>	38.1	1.50	<b>T</b>	8.5	0.33
		<b>L</b>	4.3	0.17	-	-	-

Non standard material and color: See uni Material and Color Overview.

Alternative materials: Belt: PP and PE Pin: PP **W** PA6.6 **B** PE **W** PBT **LG** and SS304 PP **W** **B** **G** Lockpin: PBT **LG** PA6.6 **N** **D**

Belt width		Permissible tensile force (Belt/pin material)						Belt weight (Belt/pin material)						*Min. No. drive sprocket per shaft	Number of wear strips (Min. No.)	
		POM-D/PP		PP/PP		PE/PP		POM-D/PP		PP/PP		PE/PP			**Carry (pcs)	**Return (pcs)
mm	in	N	lbf	N	lbf	N	lbf	kg/m	lb/ft	kg/m	lb/ft	kg/m	lb/ft			
102	4.0	1046	235	523	118	314	71	0.4	0.30	0.3	0.21	0.3	0.23	2	2	2
153	6.0	1568	353	784	176	470	106	0.7	0.45	0.5	0.32	0.5	0.34	2	2	2
191	7.5	1958	440	979	220	587	132	0.8	0.56	0.6	0.40	0.6	0.42	2	2	2
204	8.0	2091	470	1046	235	627	141	0.9	0.60	0.6	0.43	0.7	0.45	2	2	2
255	10.0	2614	588	1307	294	784	176	1.1	0.75	0.8	0.53	0.8	0.57	2	2	2
306	12.0	3137	705	1568	353	941	212	1.3	0.90	0.9	0.64	1.0	0.68	3	3	2
357	14.1	3659	823	1830	411	1098	247	1.6	1.06	1.1	0.74	1.2	0.79	3	3	2
408	16.1	4182	940	2091	470	1255	282	1.8	1.21	1.3	0.85	1.3	0.90	3	3	2
459	18.1	4705	1058	2352	529	1411	317	2.0	1.36	1.4	0.96	1.5	1.02	4	4	2
510	20.1	5228	1175	2614	588	1568	353	2.2	1.51	1.6	1.06	1.7	1.13	4	4	2
561	22.1	5750	1293	2875	646	1725	388	2.5	1.66	1.7	1.17	1.9	1.24	4	4	2
612	24.1	6273	1410	3137	705	1882	423	2.7	1.81	1.9	1.28	2.0	1.36	5	5	3
663	26.1	6796	1528	3398	764	2039	458	2.9	1.96	2.1	1.38	2.2	1.47	5	5	3

Additional standard belt widths are available in steps of 50.9 mm (2.00 in). Additional non-standard belt widths are available in steps of 12.7 mm (0.50 in).

1987	78.2	20367	4578	10183	2289	6110	1374	8.7	5.88	6.2	4.14	6.6	4.41	14	14	7
------	------	-------	------	-------	------	------	------	-----	------	-----	------	-----	------	----	----	---

Additional standard belt widths are available in steps of 50.9 mm (2.00 in). Additional non-standard belt widths are available in steps of 12.7 mm (0.50 in).

2955	116.3	30289	6809	15144	3404	9087	2043	13.0	8.74	9.2	6.16	9.8	6.55	20	20	10
------	-------	-------	------	-------	------	------	------	------	------	-----	------	-----	------	----	----	----

General belt tolerance is +/-0.4% at 23°C/73°F and 50% RH. For exact belt width contact Customer Service. Non standard belt width on request.

\*Max. Load per Drive Sprocket. Belt material: POM-D 1000 N (225 lbf). PP 600 N (135 lbf). PE 600 N (135 lbf)

\*\*Max. Spacing between wear strips. Carry: 152.0 mm (6.00 in); Return: 304.0 mm (12.00 in)

= Single Link



NON STANDARD

STRAIGHT RUNNING

PITCH 38.1 MM/1.50 IN

## Accessories

### Flight

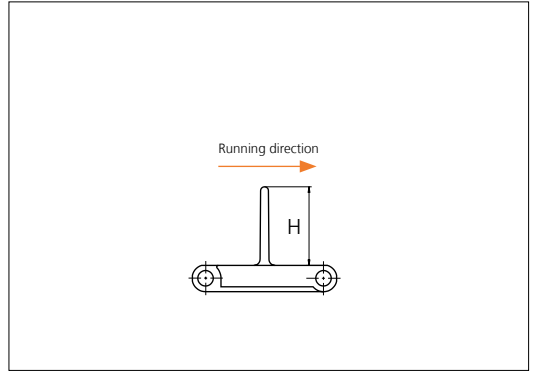
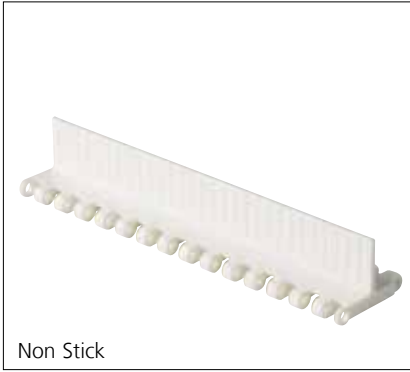

Type	Recommended Material & color	H		Link size	Width		Indent left/right	
		mm	in		mm	in	mm	in
Non Stick	POM-D <b>W</b>	25.4	1.00	K750	191.0	7.52	0.0	0.00
		50.8	2.00				17.5	0.69
Non Stick/ Support Ribs	POM-D <b>W</b>	25.4	1.00	K400	101.6	4.00	0.0	0.00
				K600	152.8	6.02	0.0	0.00
		50.8	2.00	K400	101.6	4.00	0.0	0.00
				K600	152.8	6.02	0.0	0.00
76.2	3.00	K600	152.8	6.02	0.0	0.00		

Minimum bricklaid indent for uni Light EP flights is 38.1 mm (1.50 in), increment: 12.7 mm (0.50 in).

Alternative materials: PP-I, PE.

## Accessories

### Side Guard

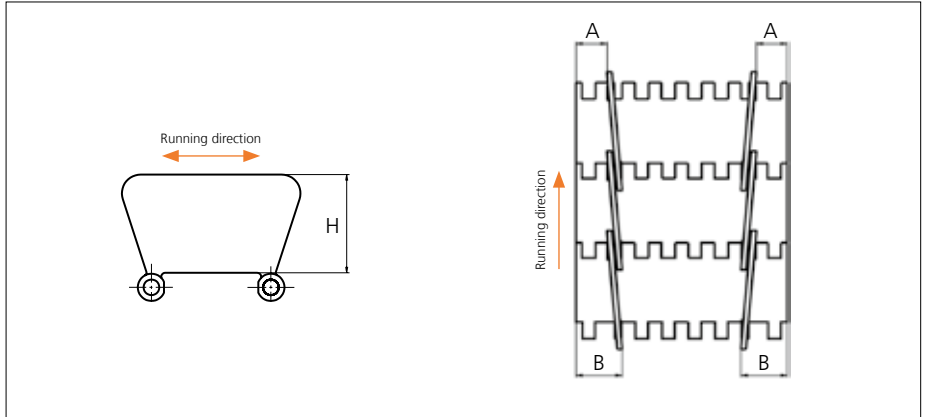



Type	Recommended Material & color	H		A		B	
		mm	in	mm	in	mm	in
Closed	POM-D <b>W</b>	31.7	1.25	15.0	0.59	23.0	0.91

Other Non Standard material and color: See uni Material and Color Overview.

## Accessories

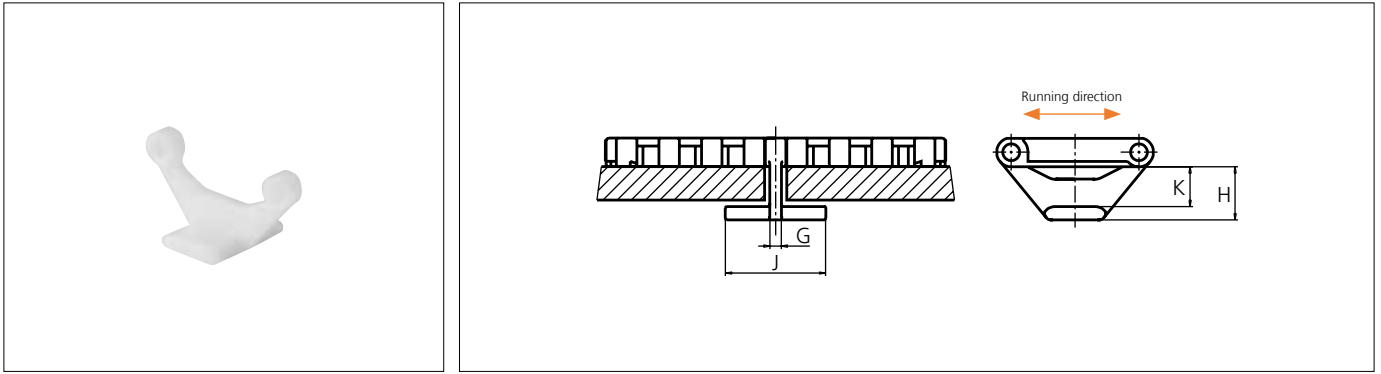
### Tab



Type	Recommended Material & color	G		J		K		H	
		mm	in	mm	in	mm	in	mm	in
Bottom Hold Down	POM-D 	3.5	0.14	26.0	1.02	12.4	0.49	16.4	0.65

Other Non Standard material and color: See uni Material and Color Overview.

## Accessories

### Non Standard uni AmFlight

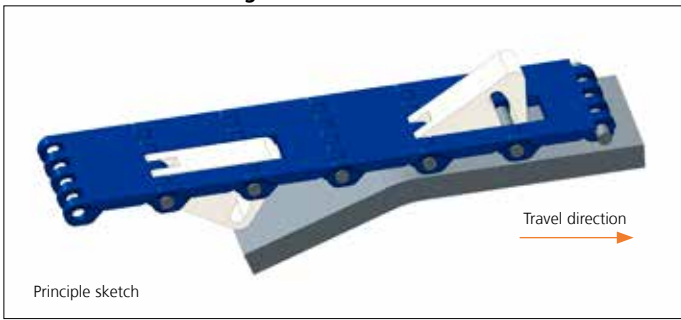

Other Non Standard option: See uni AmFlight Overview.

## Sprocket

No of teeth	Bore size						Overall diameter		Pitch-diameter		Hub-diameter		Dimension A		Dimension B		Single row/Two way	Molded	PA6 LG
	Pilot bore	in	1.00	1.18	1.25	1.50													
	mm	25.4	30.0	31.8	38.1	40.0	mm	in	mm	in	mm	in	mm	in	mm	in			
Z07			●	●	●			87.8	3.46	86.0	3.39	65.0	2.56	35.2	1.39	48.3	1.90	✓	✓
Z09			●	●	●	■	●	111.4	4.39	110.6	4.35	90.0	3.54	48.0	1.89	60.0	2.36	✓	✓
Z10			●	●	●	■	●	123.3	4.85	122.7	4.83	100.0	3.94	54.3	2.14	66.0	2.60	✓	✓
Z11			●	●	●	■	●	135.2	5.32	135.0	5.31	110.0	4.33	60.5	2.38	72.0	2.83	✓	✓
Z12				●	●	■	●	147.2	5.80	147.1	5.79	120.0	4.72	66.7	2.63	78.0	3.07	✓	✓
Z15				●	●	■	●	183.2	7.21	183.5	7.22	120.0	4.72	85.3	3.36	96.0	3.78	✓	✓

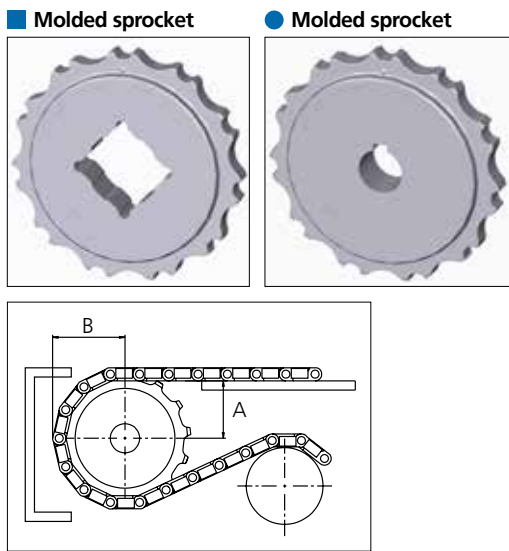

Non standard material and color: See uni Material and Color Overview.

Other sprocket sizes are available upon request.  
 Two-part sprocket are available upon request.  
 Other bore sizes are available upon request.  
 uni Retainer Rings: See uni Retainer Ring data sheet  
 Width of tooth = 11.8 mm (0.47 in)  
 Width of sprocket = 23.2 mm (0.91 in)

Max load per sprocket shown does not take bore size into account.  
 Please also ensure that sufficient size shaft is chosen for corresponding load.

For correct sprocket position: See uni Assembly Instructions for uni Light EP.  
 For more detailed sprocket information, contact Customer Service.

uni Light EP 33%/2019.05.29



Solid advice  
 For all your belting needs  
 Local stock & service  
[www.ammeraalbeltech.com](http://www.ammeraalbeltech.com)

**Ammeraal Beltech Modular A/S**  
 Hjulmagervej 21  
 DK-7100 Vejle

T +45 7572 3100  
 F +45 7572 3348  
 admin@unichains.com  
 www.unichains.com

This information is subject to alteration due to continuous development. Ammeraal Beltech will not be held liable for the incorrect use of the above stated information. This information replaces previous information. All activities performed and services rendered by Ammeraal Beltech are subject to general terms and conditions of sale and delivery, as applied by its operating companies.



# Plastic Modular Belt

Serie **uni Light EP** Type **33% Rib**

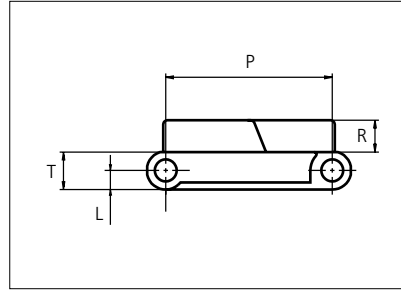
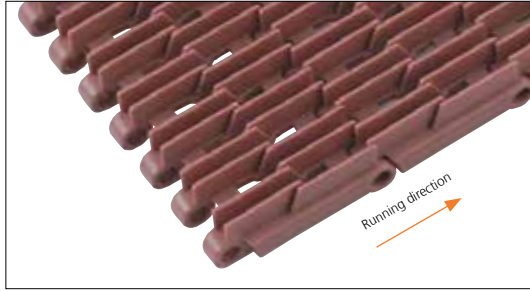

Straight running belt  
 Nominal pitch: 38.1 mm (1.50 in)  
 Surface type: Rib Top  
 Surface opening: 33%  
 Backflex radius: 150.0 mm (5.9 in)  
 Pin diameter: 5.0 mm (0.20 in)

<b>Recommended Belt material &amp; color</b>	POM-LF <b>BR</b>	<b>mm</b>	<b>in</b>	<b>mm</b>	<b>in</b>		
<b>Recommended Pin and lock material &amp; color</b>	PP <b>W</b>	<b>P (Nominal)</b>	38.1	1.50	<b>T</b>	8.5	0.33
		<b>L</b>	4.3	0.17	<b>R</b>	7.3	0.29

Non standard material and color: See uni Material and Color Overview.

Alternative materials: Belt: PP and PE Pin: PP **W** PA6.6 **B** PE **W** PBT **LG** and SS304 PP **W** **B** **G** Lockpin: PBT **LG** PA6.6 **N** **D**

Belt width		Permissible tensile force (Belt/pin material)						Belt weight (Belt/pin material)						*Min. No. drive sprocket per shaft	Number of wear strips (Min. No.)	
		POM-D/PP		PP/PP		PE/PP		POM-D/PP		PP/PP		PE/PP			**Carry (pcs)	**Return (pcs)
mm	in	N	lbf	N	lbf	N	lbf	kg/m	lb/ft	kg/m	lb/ft	kg/m	lb/ft			
102	4.0	1046	235	523	118	314	71	0.6	0.40	0.4	0.27	0.4	0.29	2	2	2
153	6.0	1568	353	784	176	470	106	0.9	0.60	0.6	0.41	0.7	0.44	2	2	2
204	8.0	2091	470	1046	235	627	141	1.2	0.80	0.8	0.55	0.9	0.59	2	2	2
255	10.0	2614	588	1307	294	784	176	1.5	0.99	1.0	0.69	1.1	0.74	2	2	2
306	12.0	3137	705	1568	353	941	212	1.8	1.19	1.2	0.82	1.3	0.88	3	3	2
357	14.1	3659	823	1830	411	1098	247	2.1	1.39	1.4	0.96	1.5	1.03	3	3	2
408	16.1	4182	940	2091	470	1255	282	2.4	1.59	1.6	1.10	1.8	1.18	3	3	2
459	18.1	4705	1058	2352	529	1411	317	2.7	1.79	1.8	1.23	2.0	1.33	4	4	2
510	20.1	5228	1175	2614	588	1568	353	3.0	1.99	2.0	1.37	2.2	1.47	4	4	2
561	22.1	5750	1293	2875	646	1725	388	3.3	2.19	2.2	1.51	2.4	1.62	4	4	2
612	24.1	6273	1410	3137	705	1882	423	3.5	2.39	2.4	1.65	2.6	1.77	5	5	3
663	26.1	6796	1528	3398	764	2039	458	3.8	2.58	2.7	1.78	2.9	1.92	5	5	3
714	28.1	7319	1645	3659	823	2196	494	4.1	2.78	2.9	1.92	3.1	2.06	5	5	3

Additional standard belt widths are available in steps of 50.9 mm (2.00 in). Additional non-standard belt widths are available in steps of 12.7 mm (0.50 in).

1987	78.2	20367	4578	10183	2289	6110	1374	11.5	7.75	7.9	5.34	8.5	5.74	14	14	7
------	------	-------	------	-------	------	------	------	------	------	-----	------	-----	------	----	----	---

Additional standard belt widths are available in steps of 50.9 mm (2.00 in). Additional non-standard belt widths are available in steps of 12.7 mm (0.50 in).

2955	116.3	30289	6809	15144	3404	9087	2043	17.1	11.52	11.8	7.94	12.7	8.54	20	20	10
------	-------	-------	------	-------	------	------	------	------	-------	------	------	------	------	----	----	----

General belt tolerance is +0/-0.4% at 23°C/73°F and 50% RH. For exact belt width contact Customer Service. Non standard belt width on request.

\*Max. Load per Drive Sprocket. Belt material: POM-D 1000 N (225 lbf). PP 600 N (135 lbf). PE 600 N (135 lbf).

\*\*Max. Spacing between wear strips. Carry: 152.0 mm (6.00 in); Return: 304.0 mm (12.00 in).

= Single Link



NON STANDARD

STRAIGHT RUNNING

PITCH 38.1 MM/1.50 IN

## Accessories

### Tab

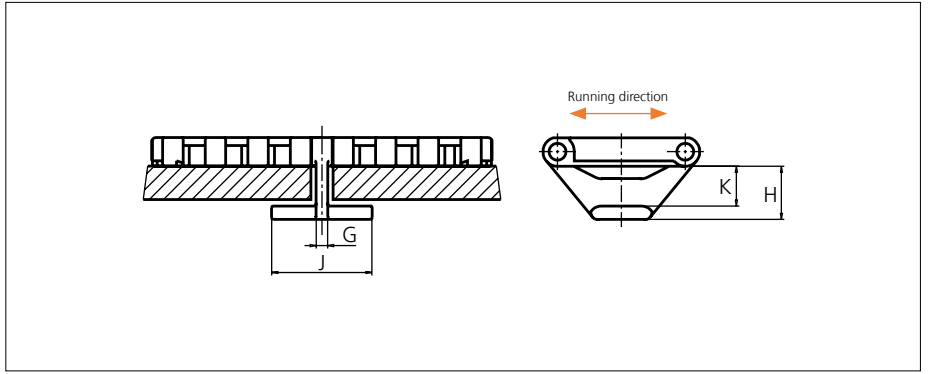

Type	Recommended Material & color	G		J		K		H	
		mm	in	mm	in	mm	in	mm	in
Bottom Hold Down	POM-D	3.5	0.14	26.0	1.02	12.4	0.49	16.4	0.65

Other Non Standard material and color: See uni Material and Color Overview.

## Accessories

### Finger Plates

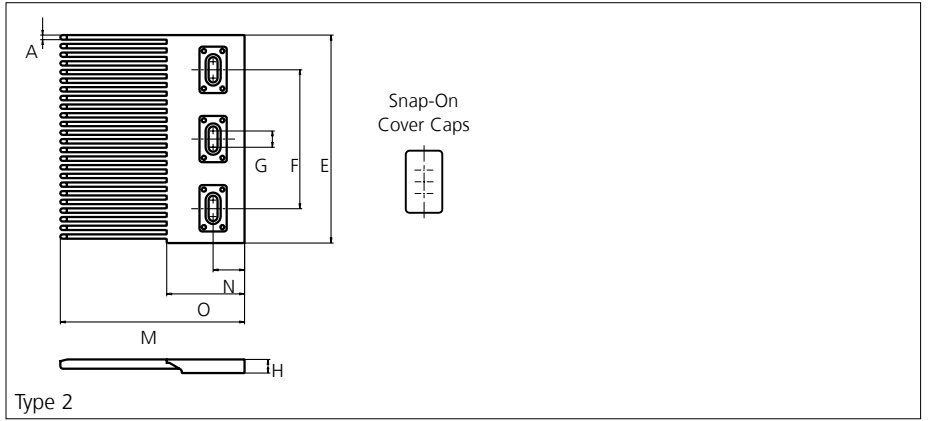
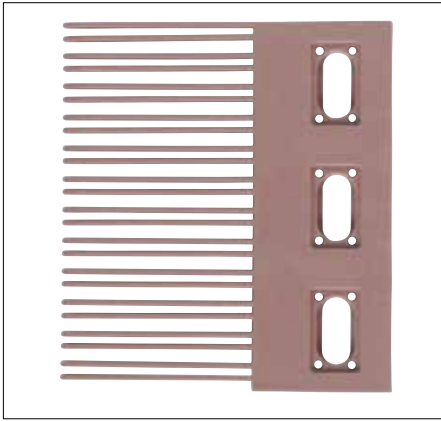

Type	Recommended Material & color	A		E		F		G		H		M		N		O	
		mm	in	mm	in	mm	in	mm	in	mm	in	mm	in	mm	in		
Single Sided	POM-LF	3.3	0.13	152.4	6.00	101.6	4.00	12.0	0.47	10.3	0.41	135.0	5.31	23.0	0.91	57.0	2.24

All uni-chains belt systems are available in a raised rib version that can be supplied with matching finger plates, also called combs.

The finger plates are supplied with cover caps which can be attached when the finger plate has been installed. The cover caps can be removed by using a screwdriver that can be inserted between the cover and finger plate.

Non Standard material and color: See uni Material and Color Overview.



## Sprocket

No of teeth	Bore size						Overall diameter		Pitch-diameter		Hub-diameter		Dimension A		Dimension B		Single row/Two way	Molded PA6 LG	
	Pilot bore	in	1.00	1.18	1.25	1.50													1.57
	mm	25.4	30.0	31.8	38.1	40.0	mm	in	mm	in	mm	in	mm	in	mm	in			
Z07			●	●	●													✓	✓
Z09			●	●	●	■	●											✓	✓
Z10			●	●	●	■	■	●										✓	✓
Z11			●	●	●	■	■	■										✓	✓
Z12				●	●	■	■	■	●									✓	✓
Z15				●	●	■	■	■	■									✓	✓

■ Molded sprocket

● Molded sprocket

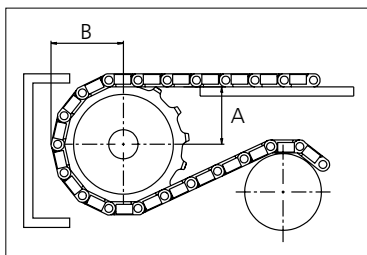
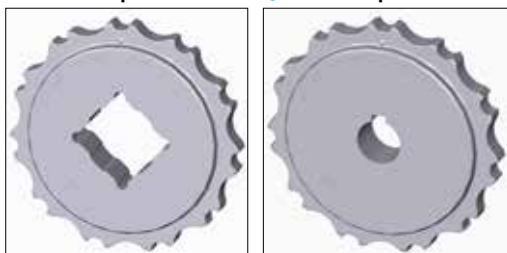

Other sprocket sizes are available upon request.

Two-part sprocket are available upon request.

Other bore sizes are available upon request.

uni Retainer Rings: See uni Retainer Ring data sheet

Width of tooth = 11.8 mm (0.47 in)

Width of sprocket = 23.2 mm (0.91 in)

Max load per sprocket shown does not take bore size into account.

Please also ensure that sufficient size shaft is chosen for corresponding load.

For correct sprocket position: See uni Assembly Instructions for uni Light EP.

For more detailed sprocket information, contact Customer Service.

Non standard material and color: See uni Material and Color Overview.



Conveyor Belts



Seamless Belts

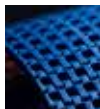

Modular Belts



Timing Belts

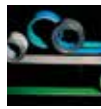

Transmission Belts



Fabrication & service

Solid advice  
For all your belting needs  
Local stock & service  
[www.ammeraalbeltech.com](http://www.ammeraalbeltech.com)

**Ammeraal Beltech Modular A/S**  
Hjulmagervej 21  
DK-7100 Vejle

T +45 7572 3100  
F +45 7572 3348  
admin@unichains.com  
www.unichains.com

This information is subject to alteration due to continuous development. Ammeraal Beltech will not be held liable for the incorrect use of the above stated information. This information replaces previous information. All activities performed and services rendered by Ammeraal Beltech are subject to general terms and conditions of sale and delivery, as applied by its operating companies.



# Plastic Modular Belt

Serie **uni Light EP** Type **46%**

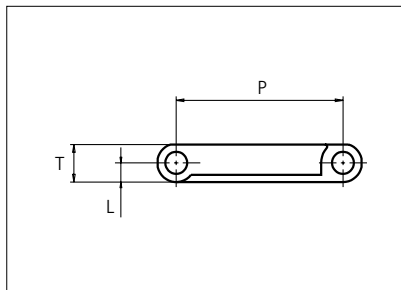
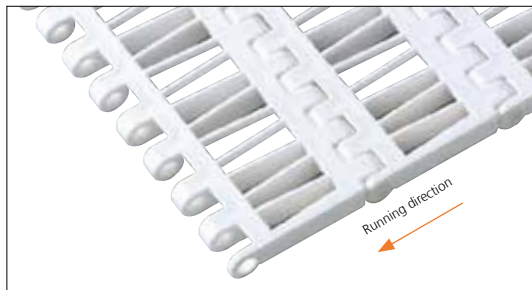

Straight running belt  
 Nominal pitch: 38.1 mm (1.50 in)  
 Surface type: Flat  
 Surface opening: 46%  
 Backflex radius: 75.0 mm (3.0 in)  
 Pin diameter: 5.0 mm (0.20 in)

<b>Recommended Belt material &amp; color</b>	POM-D	<b>mm</b>	<b>in</b>		<b>mm</b>	<b>in</b>	
<b>Recommended Pin and lock material &amp; color</b>	PP	<b>P (Nominal)</b>	38.1	1.50	<b>T</b>	8.5	0.33
		<b>L</b>	4.3	0.17	-	-	-

Non standard material and color: See uni Material and Color Overview.

Alternative materials: Belt: PP and PE Pin: PP PA6.6 PE PBT LG and SS304 PP B G PP W

Lockpin: PBT LG PA6.6 N D

Belt width		Permissible tensile force (Belt/pin material)						Belt weight (Belt/pin material)						*Min. No. drive sprocket per shaft	Number of wear strips (Min. No.)	
		POM-D/PP		PP/PP		PE/PP		POM-D/PP		PP/PP		PE/PP			**Carry (pcs)	**Return (pcs)
mm	in	N	lbf	N	lbf	N	lbf	kg/m	lb/ft	kg/m	lb/ft	kg/m	lb/ft			
102	4.0	1046	235	523	118	314	71	0.4	0.30	0.3	0.21	0.3	0.23	2	2	2
153	6.0	1568	353	784	176	470	106	0.7	0.45	0.5	0.32	0.5	0.34	2	2	2
204	8.0	2091	470	1046	235	627	141	0.9	0.60	0.6	0.43	0.7	0.45	2	2	2
255	10.0	2614	588	1307	294	784	176	1.1	0.75	0.8	0.53	0.8	0.57	2	2	2
306	12.0	3137	705	1568	353	941	212	1.3	0.90	0.9	0.64	1.0	0.68	3	3	2
357	14.1	3659	823	1830	411	1098	247	1.6	1.06	1.1	0.74	1.2	0.79	3	3	2
408	16.1	4182	940	2091	470	1255	282	1.8	1.21	1.3	0.85	1.3	0.90	3	3	2
459	18.1	4705	1058	2352	529	1411	317	2.0	1.36	1.4	0.96	1.5	1.02	4	4	2
510	20.1	5228	1175	2614	588	1568	353	2.2	1.51	1.6	1.06	1.7	1.13	4	4	2
561	22.1	5750	1293	2875	646	1725	388	2.5	1.66	1.7	1.17	1.9	1.24	4	4	2
612	24.1	6273	1410	3137	705	1882	423	2.7	1.81	1.9	1.28	2.0	1.36	5	5	3
663	26.1	6796	1528	3398	764	2039	458	2.9	1.96	2.1	1.38	2.2	1.47	5	5	3
714	28.1	7319	1645	3659	823	2196	494	3.1	2.11	2.2	1.49	2.4	1.58	5	5	3

Additional standard belt widths are available in steps of 50.9 mm (2.00 in). Additional non-standard belt widths are available in steps of 12.7 mm (0.50 in).

1987	78.2	20367	4578	10183	2289	6110	1374	8.7	5.88	6.2	4.14	6.6	4.41	14	14	7
------	------	-------	------	-------	------	------	------	-----	------	-----	------	-----	------	----	----	---

Additional standard belt widths are available in steps of 50.9 mm (2.00 in). Additional non-standard belt widths are available in steps of 12.7 mm (0.50 in).

2955	116.3	30289	6809	15144	3404	9087	2043	13.0	8.74	9.2	6.16	9.8	6.55	20	20	10
------	-------	-------	------	-------	------	------	------	------	------	-----	------	-----	------	----	----	----

General belt tolerance is +/-0.4% at 23°C/73°F and 50% RH. For exact belt width contact Customer Service. Non standard belt width on request.

\*Max. Load per Drive Sprocket. Belt material: POM-D 1000 N (225 lbf). PP 600 N (135 lbf). PE 600 N (135 lbf).

\*\*Max. Spacing between wear strips. Carry: 152.0 mm (6.00 in); Return: 304.0 mm (12.00 in).

= Single Link



NON STANDARD

STRAIGHT RUNNING

PITCH 38.1 MM/1.50 IN

## Accessories

### Flight

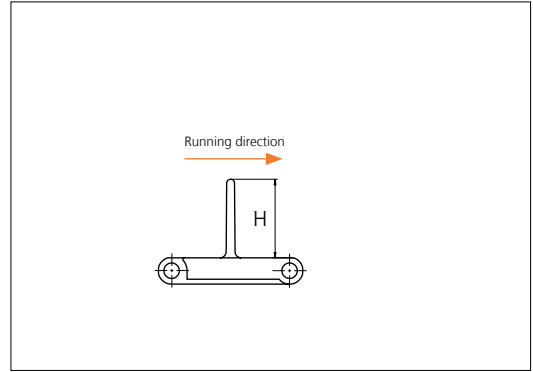
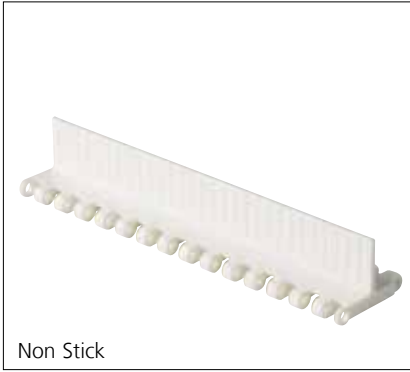

Type	Recommended Material & color	H		Link size	Width		Indent left/right	
		mm	in		mm	in	mm	in
Non Stick	POM-D <b>W</b>	25.4	1.00	K750	191.0	7.52	0.0	0.00
		50.8	2.00				17.5	0.69
Non Stick/ Support Ribs	POM-D <b>W</b>	25.4	1.00	K400	101.6	4.00	0.0	0.00
				K600	152.8	6.02	0.0	0.00
		50.8	2.00	K400	101.6	4.00	0.0	0.00
				K600	152.8	6.02	0.0	0.00
76.2	3.00	K600	152.8	6.02	0.0	0.00		

Minimum bricklaid indent for uni Light EP flights is 38.1 mm (1.50 in), increment: 12.7 mm (0.50 in).

Alternative materials: PP-I, PE.

Non Standard material and color: See uni Material and Color Overview.

## Accessories

### Side Guard

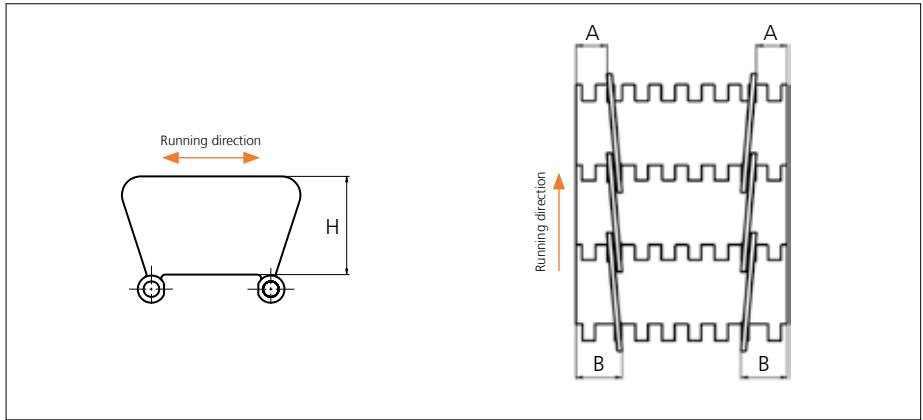



Type	Recommended Material & color	H		A		B	
		mm	in	mm	in	mm	in
Closed	POM-D <b>W</b>	31.7	1.25	15.0	0.59	23.0	0.91

Other Non Standard material and color: See uni Material and Color Overview.

## Accessories

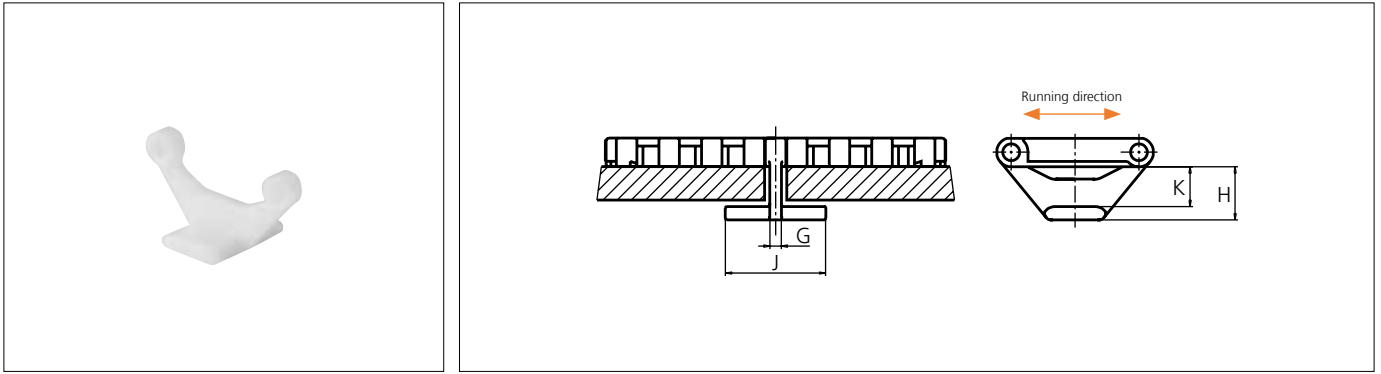
### Tab



Type	Recommended Material & color	G		J		K		H	
		mm	in	mm	in	mm	in	mm	in
Bottom Hold Down	POM-D 	3.5	0.14	26.0	1.02	12.4	0.49	16.4	0.65

Other Non Standard material and color: See uni Material and Color Overview.

## Accessories

### Non Standard uni AmFlight

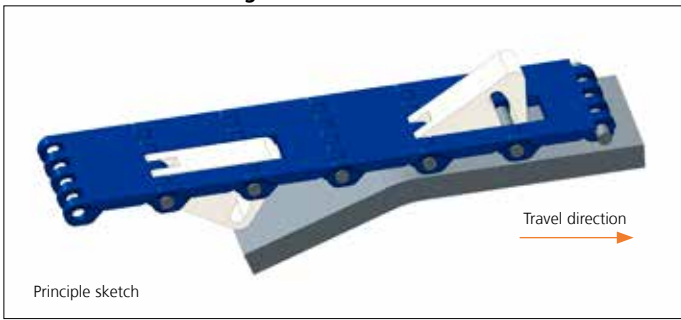

Other Non Standard option: See uni AmFlight Overview.

## Sprocket

No of teeth	Bore size						Overall diameter		Pitch-diameter		Hub-diameter		Dimension A		Dimension B		Single row/Two way	Molded
	Pilot bore	1.00		1.25		1.57												
	mm	25.4	30.0	31.8	38.1	40.0	mm	in	mm	in	mm	in	mm	in	mm	in		
Z07		●	●	●			87.8	3.46	86.0	3.39	65.0	2.56	35.2	1.39	48.3	1.90	✓	✓
Z09		●	●	●	■	●	111.4	4.39	110.6	4.35	90.0	3.54	48.0	1.89	60.0	2.36	✓	✓
Z10		●	●	●	■	●	123.3	4.85	122.7	4.83	100.0	3.94	54.3	2.14	66.0	2.60	✓	✓
Z11		●	●	●	■	●	135.2	5.32	135.0	5.31	110.0	4.33	60.5	2.38	72.0	2.83	✓	✓
Z12			●	●	●	●	147.2	5.80	147.1	5.79	120.0	4.72	66.7	2.63	78.0	3.07	✓	✓
Z15			●	●	●	●	183.2	7.21	183.5	7.22	120.0	4.72	85.3	3.36	96.0	3.78	✓	✓

■ Molded sprocket

● Molded sprocket

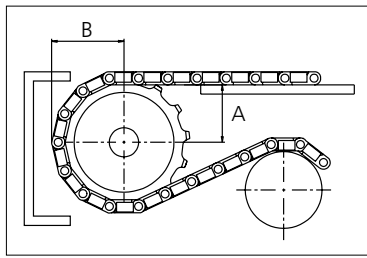
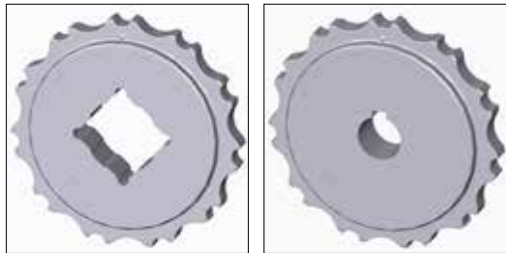

Other sprocket sizes are available upon request.  
 Two-part sprocket are available upon request.  
 Other bore sizes are available upon request.  
 uni Retainer Rings: See uni Retainer Ring data sheet  
 Width of tooth = 11.8 mm (0.47 in)  
 Width of sprocket = 23.2 mm (0.91 in)

Max load per sprocket shown does not take bore size into account.  
 Please also ensure that sufficient size shaft is chosen for corresponding load.

For correct sprocket position: See uni Assembly Instructions for uni Light EP.  
 For more detailed sprocket information, contact Customer Service.

Non standard material and color: See uni Material and Color Overview.

uni Light EP 46%/2019.05.29



Solid advice  
 For all your belting needs  
 Local stock & service  
[www.ammeraalbeltech.com](http://www.ammeraalbeltech.com)

**Ammeraal Beltech Modular A/S**  
 Hjulmagervej 21  
 DK-7100 Vejle

T +45 7572 3100  
 F +45 7572 3348  
 admin@unichains.com  
 www.unichains.com

This information is subject to alteration due to continuous development. Ammeraal Beltech will not be held liable for the incorrect use of the above stated information. This information replaces previous information. All activities performed and services rendered by Ammeraal Beltech are subject to general terms and conditions of sale and delivery, as applied by its operating companies.



# Plastic Modular Belt

Serie **uni Light EP** Type **Vacuum**

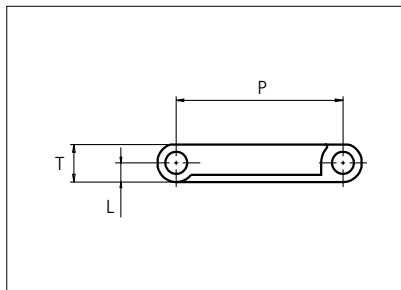
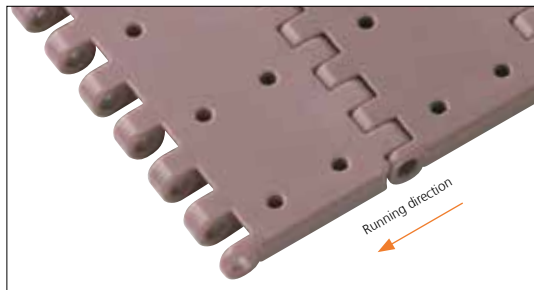

Straight running belt  
 Nominal pitch: 38.1 mm (1.50 in)  
 Surface type: Flat  
 Surface opening: Closed  
 Backflex radius: 75.0 mm (3.0 in)  
 Pin diameter: 5.0 mm (0.13 in)

**Vacuum holes: ø3.2 mm (0.13 in)**

<b>Recommended Belt material &amp; color</b>	POM-LF <b>BR</b>	<b>mm</b>	<b>in</b>	<b>mm</b>	<b>in</b>		
<b>Recommended Pin and lock material &amp; color</b>	PP <b>W</b>	<b>P (Nominal)</b>	38.1	1.50	<b>T</b>	8.5	0.33
		<b>L</b>	4.3	0.17	-	-	-

Non standard material and color: See uni Material and Color Overview.

Alternative materials: Belt: PP and PE Pin: PP **W** PA6.6 **B** PE **W** PBT **LG** and SS304 PP **W** **B** **G** Lockpin: PBT **LG** PA6.6 **N** **D**

Belt width		Permissible tensile force (Belt/pin material)						Belt weight (Belt/pin material)						*Min. No. drive sprocket per shaft	Number of wear strips (Min. No.)	
		POM-D/PP		PP/PP		PE/PP		POM-D/PP		PP/PP		PE/PP			**Carry (pcs)	**Return (pcs)
mm	in	N	lbf	N	lbf	N	lbf	kg/m	lb/ft	kg/m	lb/ft	kg/m	lb/ft			
102	4.0	1046	235	523	118	314	71	0.6	0.39	0.4	0.25	0.4	0.27	2	2	2
153	6.0	1568	353	784	176	470	106	0.9	0.59	0.6	0.38	0.6	0.41	2	2	2
204	8.0	2091	470	1046	235	627	141	1.2	0.78	0.8	0.51	0.8	0.55	2	2	2
255	10.0	2614	588	1307	294	784	176	1.5	0.98	0.9	0.63	1.0	0.69	2	2	2
306	12.0	3137	705	1568	353	941	212	1.7	1.17	1.1	0.76	1.2	0.82	3	3	2
357	14.1	3659	823	1830	411	1098	247	2.0	1.37	1.3	0.89	1.4	0.96	3	3	2
408	16.1	4182	940	2091	470	1255	282	2.3	1.56	1.5	1.01	1.6	1.10	3	3	2
459	18.1	4705	1058	2352	529	1411	317	2.6	1.76	1.7	1.14	1.8	1.23	4	4	2
510	20.1	5228	1175	2614	588	1568	353	2.9	1.95	1.9	1.27	2.0	1.37	4	4	2
561	22.1	5750	1293	2875	646	1725	388	3.2	2.15	2.1	1.39	2.2	1.51	4	4	2
612	24.1	6273	1410	3137	705	1882	423	3.5	2.34	2.3	1.52	2.4	1.65	5	5	3
663	26.1	6796	1528	3398	764	2039	458	3.8	2.54	2.5	1.65	2.7	1.78	5	5	3
714	28.1	7319	1645	3659	823	2196	494	4.1	2.74	2.6	1.78	2.9	1.92	5	5	3

Additional standard belt widths are available in steps of 50.9 mm (2.00 in). Additional non-standard belt widths are available in steps of 12.7 mm (0.50 in).

1987	78.2	20367	4578	10183	2289	6110	1374	11.3	7.61	7.4	4.94	7.9	5.34	14	14	7
------	------	-------	------	-------	------	------	------	------	------	-----	------	-----	------	----	----	---

Additional standard belt widths are available in steps of 50.9 mm (2.00 in). Additional non-standard belt widths are available in steps of 12.7 mm (0.50 in).

2955	116.3	30289	6809	15144	3404	9087	2043	16.8	11.32	10.9	7.35	11.8	7.94	20	20	10
------	-------	-------	------	-------	------	------	------	------	-------	------	------	------	------	----	----	----

General belt tolerance is +0/-0.4% at 23°C/73°F and 50% RH. For exact belt width contact Customer Service. Non standard belt width on request.

\*Max. Load per Drive Sprocket. Belt material: POM-D 1000 N (225 lbf). PP 600 N (135 lbf). PE 600 N (135 lbf)

\*\*Max. Spacing between wear strips. Carry: 152.0 mm (6.00 in); Return: 304.0 mm (12.00 in).

= Single Link



NON STANDARD

STRAIGHT RUNNING

PITCH 38.1 MM/1.50 IN

## Accessories

### Tab

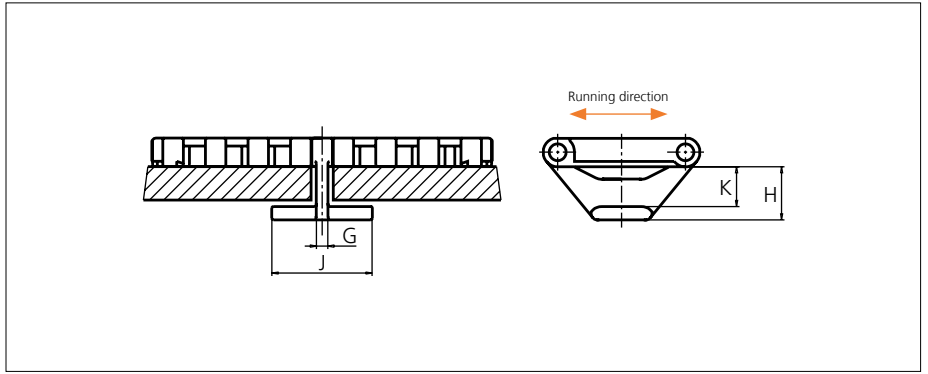

Type	Recommended Material & color	G		J		K		H	
		mm	in	mm	in	mm	in	mm	in
Bottom Hold Down	POM-D 	3.5	0.14	26.0	1.02	12.4	0.49	16.4	0.65

Other Non Standard material and color: See uni Material and Color Overview.

## Accessories

### Non Standard uni AmFlight

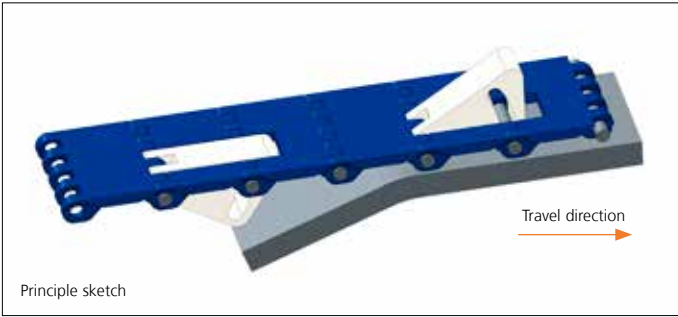

Other Non Standard option: See uni AmFlight Overview.



## Sprocket

No of teeth	Bore size						Overall diameter		Pitch-diameter		Hub-diameter		Dimension A		Dimension B		Single row/Two way	Molded	PA6 LG
	Pilot bore	in	1.00	1.18	1.25	1.50													
	mm	25.4	30.0	31.8	38.1	40.0	mm	in	mm	in	mm	in	mm	in	mm	in			
Z07			●	●	●			87.8	3.46	86.0	3.39	65.0	2.56	35.2	1.39	48.3	1.90	✓	✓
Z09			●	●	●	■	●	111.4	4.39	110.6	4.35	90.0	3.54	48.0	1.89	60.0	2.36	✓	✓
Z10			●	●	●	■	●	123.3	4.85	122.7	4.83	100.0	3.94	54.3	2.14	66.0	2.60	✓	✓
Z11			●	●	●	■	●	135.2	5.32	135.0	5.31	110.0	4.33	60.5	2.38	72.0	2.83	✓	✓
Z12				●	●	●	●	147.2	5.80	147.1	5.79	120.0	4.72	66.7	2.63	78.0	3.07	✓	✓
Z15				●	●	●	●	183.2	7.21	183.5	7.22	120.0	4.72	85.3	3.36	96.0	3.78	✓	✓

■ Molded sprocket

● Molded sprocket

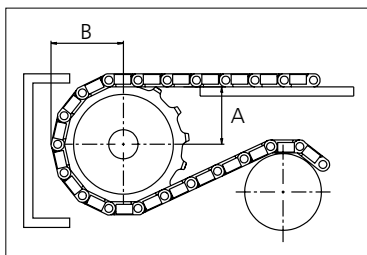
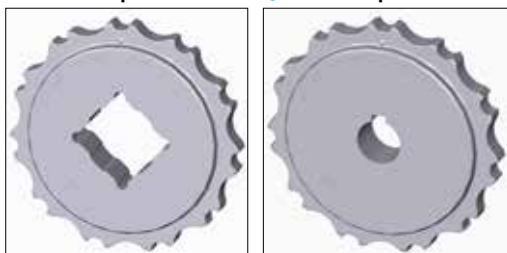

Other sprocket sizes are available upon request.

Two-part sprocket are available upon request.

Other bore sizes are available upon request.

uni Retainer Rings: See uni Retainer Ring data sheet

Width of tooth = 11.8 mm (0.47 in)

Width of sprocket = 23.2 mm (0.91 in)

Max load per sprocket shown does not take bore size into account.

Please also ensure that sufficient size shaft is chosen for corresponding load.

For correct sprocket position: See uni Assembly Instructions for uni Light EP.

For more detailed sprocket information, contact Customer Service.

Non standard material and color: See uni Material and Color Overview.



Conveyor Belts



Seamless Belts

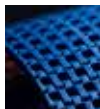

Modular Belts



Timing Belts

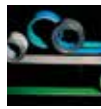

Transmission Belts



Fabrication & service

Solid advice  
For all your belting needs  
Local stock & service  
[www.ammeraalbeltech.com](http://www.ammeraalbeltech.com)

**Ammeraal Beltech Modular A/S**  
Hjulmagervej 21  
DK-7100 Vejle

T +45 7572 3100  
F +45 7572 3348  
admin@unichains.com  
www.unichains.com

This information is subject to alteration due to continuous development. Ammeraal Beltech will not be held liable for the incorrect use of the above stated information. This information replaces previous information. All activities performed and services rendered by Ammeraal Beltech are subject to general terms and conditions of sale and delivery, as applied by its operating companies.



# Plastic Modular Belt

Series **uni LPB** Type **Rough**

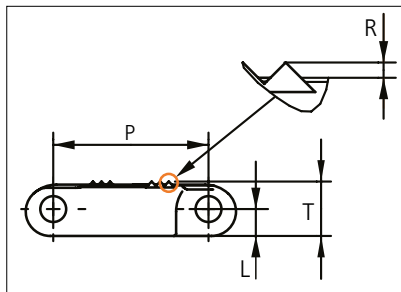

Straight running belt  
 Nominal pitch: 25.4 mm (1.00 in)  
 Surface type: Rough POM-NL (R10)  
 Surface type: Rough PP-FREC (R11)  
 Surface opening: Closed  
 Backflex radius: 25.0 mm (0.98 in)  
 Pin diameter: 4.0 mm (0.16 in)

Belt material & color	POM-NL <b>K</b>	PP-FREC <b>K</b>	mm		in			
	Pin material & color: PA6.6 <b>B</b>		P (Nominal)	25.4	1.00	R	0.9	0.04
			L	4.4	0.17	T	8.9	0.35

Non standard material and color: See uni Material and Color Overview.

Alternative pin and lock materials: Lockpin: PBT **LG**

Belt width		Permissible tensile force (Belt/pin material)				***Belt weight (Belt/pin material)				Min No drive sprocket per shaft	Number of wear strips (min no)	
		POM-NL/PA66		PP-FREC/PA66		POM-NL/PA66		PP-FREC/PA66			**Carry (pcs)	**Return (pcs)
mm	in	N	lbf	N	lbf	Kg/m	lb/ft	Kg/m	lb/ft			
153	6.0	5355	1204	1913	430	1.0	0.68	0.7	0.45	2	1	1
229	9.0	8015	1802	2863	643	1.5	1.02	1.0	0.68	2	1	1
305	12.0	10675	2400	3813	857	2.0	1.35	1.3	0.90	3	3	2
381	15.0	13335	2998	4763	1071	2.5	1.69	1.7	1.13	3	3	2
457	18.0	15995	3596	5713	1284	3.0	2.03	2.0	1.35	4	4	2
533	21.0	18655	4194	6663	1498	3.5	2.36	2.3	1.58	4	4	2
609	24.0	21315	4792	7613	1711	4.0	2.70	2.7	1.80	5	5	3
686	27.0	24010	5397	8575	1928	4.5	3.04	3.0	2.03	5	5	3
762	30.0	26670	5995	9525	2141	5.0	3.38	3.4	2.25	6	6	3
838	33.0	29330	6593	10475	2355	5.5	3.72	3.7	2.48	6	6	3
914	36.0	31990	7191	11425	2568	6.0	4.05	4.0	2.70	7	7	4
990	39.0	34650	7789	12375	2782	6.5	4.39	4.4	2.93	7	7	4

Additional standard belt widths are available in steps of 76.0 mm (2.99 in). Additional non-standard belt widths are available in steps of 76.0 mm (2.99 in).

1979	77.9	69265	15571	24738	5561	13.1	8.78	8.7	5.85	14	14	7
------	------	-------	-------	-------	------	------	------	-----	------	----	----	---

Additional standard belt widths are available in steps of 76.0 mm (2.99 in). Additional non-standard belt widths are available in steps of 76.0 mm (2.99 in).

2969	116.9	103915	23360	37113	8343	19.6	13.17	13.1	8.78	20	20	10
------	-------	--------	-------	-------	------	------	-------	------	------	----	----	----

General belt tolerance is +0/-0.4% at 23°C/73°F and 50% RH. For exact belt width contact Customer Service. Non standard belt width on request

\*Max. Load per Drive Sprocket. Belt material: POM-NL 2300 N (517 lbf), PP-FREC 1300 N (292 lbf)

\*\*Full Carry way support (FS) deck of wearstrip material recommended for safe walk belts.

\*\*\*Return belt support via free running gravity rollers recommended to avoid marking safe walk belt surface.

Surface grip in material NL (R10), PP-FREC (R11).

= Single Link



STANDARD

STRAIGHT RUNNING

PITCH 25.4 MM/1.00 IN

## Sprocket

No. of teeth	Bore size										Overall diameter		Pitch diameter		Hub diameter		Dimension A		Dimension B		Single row/Two way	Moulded	PA6 LG
	Pilot bore	in		mm		mm		mm															
		mm	25.4	30.0	31.8	38.1	40.0	60.0	63.5	mm	in	mm	in	mm	in	mm	in	mm	in				
Z10	✓		●	●	●	■				80.3	3.16	82.2	3.24	65.0	2.56	34.7	1.36	45.5	1.79	✓	✓		
Z12	✓		●	●	●	■				96.8	3.81	98.1	3.86	70.0	2.76	43.0	1.69	53.5	2.11	✓	✓		
Z15	✓			●	●	■	■	■	■	121.5	4.78	122.2	4.81	<sup>1</sup> 70.0 <sup>2</sup> 100.0 <sup>2</sup> 104.0	2.76 13.94 4.09	55.4	2.18	65.5	2.58	✓	✓		
Z18	✓			●	●	■	■	■	■	146.0	5.75	146.3	5.76	<sup>1</sup> 70.0 <sup>1</sup> 120.0 <sup>2</sup> 104.0	2.76 4.72 4.09	67.6	2.66	77.5	3.05	✓	✓		
Z19	✓			●	●	■	■	■	■	154.2	6.07	154.3	6.07	<sup>1</sup> 70.0 <sup>1</sup> 120.0 <sup>2</sup> 104.0	2.76 4.72 4.09	71.7	2.82	81.6	3.21	✓	✓		

● Moulded sprocket   ■ Moulded sprocket   ■ Moulded sprocket



Other sprocket sizes are available upon request.  
 Round bores are always delivered with keyway.  
 Max load per sprocket shown does not take bore size into account.  
 Please also ensure that sufficient size shaft is chosen for corresponding load.  
 Other bore sizes are available upon request.  
 uni Retainer Rings: See uni Retainer Ring data sheet.  
 Width of tooth = 10.0 mm (0.39 in)  
 Width of OnePart sprocket = 25.0 mm (0.98 in)

## uni UltraFit Two-Part Sprocket

No. of teeth	Bore size					Overall diameter		Pitch diameter		Hub/adaptor diameter		Hub/adaptor width		Dimension A		Dimension B		Single row/Two way	Moulded	PA6 LG	Adaptor Moulded	POM-D B
	in		mm		mm																	
	mm	38.1	40.0	60.0	63.5	mm	in	mm	in	mm	in	mm	in	mm	in							
Z12		■	■			96.8	3.81	98.2	3.87	83.0	3.27	25.0 76.0	0.98 2.99	43	1.69	53.5	2.11	✓	✓	✓	✓	
Z13		■	■			104.8	4.13	106.2	4.18	83.0	3.27	25.0 76.0	0.98 2.99	47.1	1.86	57.1	2.25	✓	✓	✓	✓	
Z15		■	■	■	■	121.5	4.78	122.5	4.82	106.0	4.14	25.0 76.0	0.98 2.99	55.4	2.18	65.5	2.58	✓	✓	✓	✓	
Z16		■	■	■	■	129.7	5.11	130.2	5.13	106.0	4.14	25.0 76.0	0.98 2.99	59.5	2.35	69.5	2.74	✓	✓	✓	✓	
Z18		■	■	■	■	146.1	5.75	146.3	5.76	106.0	4.14	25.0 76.0	0.98 2.99	67.6	2.66	77.5	3.05	✓	✓	✓	✓	
Z19		■	■	■	■	154.2	6.07	154.3	6.07	106.0	4.14	25.0 76.0	0.98 2.99	71.7	2.82	81.6	3.21	✓	✓	✓	✓	

■ Moulded uni UltraFit TwoPart Sprocket (Narrow adapter)   ■ Moulded uni UltraFit TwoPart Sprocket (Wide adapter)

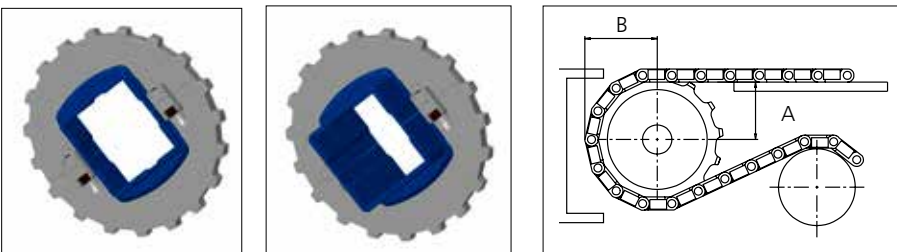

For correct sprocket position:  
 See uni Assembly Instructions for uni QNB.  
 For more detailed sprocket information contact Customer Service.

uni LPB Rough/181008



Expert advice, quality solutions and local service for all your belting needs  
[www.ammeraalbeltech.com](http://www.ammeraalbeltech.com)

**Ammeraal Beltech Modular A/S**  
 Hjulmagervej 21  
 DK-7100 Vejle

T +45 7572 3100  
 F +45 7572 3348  
 admin@unichains.com  
 www.unichains.com

This information is subject to alteration due to continuous development. Ammeraal Beltech will not be held liable for the incorrect use of the above stated information. This information replaces previous information. All activities performed and services rendered by Ammeraal Beltech are subject to general terms and conditions of sale and delivery, as applied by its operating companies.



# Plastic Modular Belt

Series **uni M-OWL** Type **40% Open**

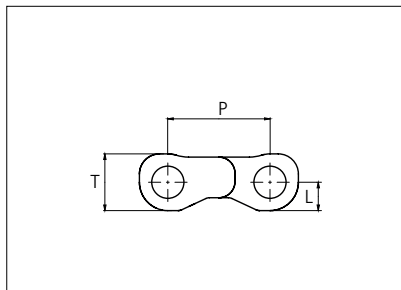
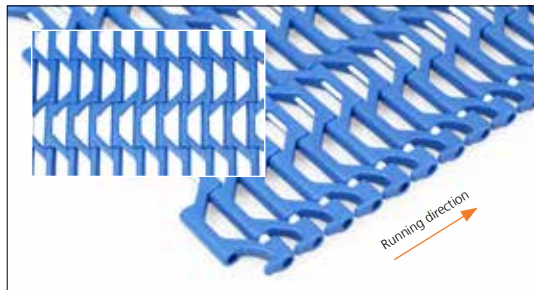

Straight Running  
 Nominal pitch: 12.7 mm (0.50 in)  
 Contact area: 8%  
 Surface opening: 40%  
 Backflex radius: 12.5 mm (0.49 in)  
 Pin diameter: 4.0 mm (0.16 in)  
 Largest opening: 7.6 x 23 mm  
 (0.30 x 0.91 in)

<b>Belt material &amp; color</b>	POM-D <b>B</b> <b>W</b>		<b>mm</b>	<b>in</b>		<b>mm</b>	<b>in</b>
<b>Pin material &amp; color</b>	PP <b>W</b>	<b>P (Nominal)</b>	12.7	0.50	<b>T</b>	7.2	0.28
		<b>L</b>	3.6	0.14	-	-	-

Non standard material and color: See uni Material and Color Overview.

Alternative pin materials: Lockpin: PA6.6 **B**

Belt width		Permissible tensile force (Belt material)		Belt weight (Belt material)		*Min. No. drive sprocket per shaft	Number of wear strips (Min. No.)	
		POM-D		POM-D			**Carry (pcs)	**Return (pcs)
mm	in	N	lbf	kg/m	lb/ft			
203	8.0	914	205	0.9	0.59	2	2	2
254	10.0	1143	257	1.1	0.74	3	2	2
305	12.0	1373	309	1.3	0.89	4	3	2
356	14.0	1602	360	1.5	1.04	4	3	2
407	16.0	1832	412	1.8	1.18	5	3	2
457	18.0	2057	462	2.0	1.33	5	4	2
508	20.0	2286	514	2.2	1.48	5	4	2
559	22.0	2516	565	2.4	1.63	6	4	2
610	24.0	2745	617	2.6	1.78	7	5	3
660	26.0	2970	668	2.9	1.92	7	5	3
711	28.0	3200	719	3.1	2.07	7	5	3
762	30.0	3429	771	3.3	2.22	8	6	3

Additional standard belt widths are available in steps of 50.7 mm (2.00 in).

1980	78.0	8910	2003	8.6	5.76	20	14	7
------	------	------	------	-----	------	----	----	---

Additional standard belt widths are available in steps of 50.7 mm (2.00 in).

2996	118.0	13482	3031	13.0	8.72	30	20	10
------	-------	-------	------	------	------	----	----	----

General belt tolerance is +0/-0.4% at 23°C/73°F and 50% RH. For exact belt width contact Customer Service.

\*Max. Load per Drive Sprocket. Belt material: POM-D with snub roller 1000 N (450 lbf) without snub roller 500 N (281 lbf).

\*\*Max. Spacing between wear strips, Carry: 152.0 mm (6.00 in); Return: 304.0 mm (12.00 in).

= Single Link



STANDARD

STRAIGHT RUNNING

PITCH 12.7 MM/0.50 IN

## Sprocket

No. of teeth	Bore size													Overall diameter		Pitch-diameter		Hub-diameter		A-dimension		B-dimension		Single row/Two way	Double row/Two way	Molded PA6 LG	Machined PA6 N
	Pilot bore		in	0.75	0.78	0.98	1.00	1.18	1.25	1.50	1.57	2.36	2.50														
	mm	19.1	20.0	25.0	25.4	30.0	31.8	38.1	40.0	60.0	63.5	90.0	mm	in	mm	in	mm	in	mm	in							
Z14	x		●	●●								61.4	2.42	58.0	2.28	44.9	1.77	24.73	0.97	32.7	1.29	x			x		
Z17	x			●●								73.6	2.90	70.2	2.76	57.1	2.25	30.98	1.22	38.79	1.53	x			x		
Z19	x				●				●●	●●		81.8	3.22	78.4	3.09	65.3	2.57	35.13	1.38	42.86	1.69	x			x		
Z24	x							●●	●●	●●		102.2	4.02	98.8	3.89	85.8	3.38	45.47	1.79	53.06	2.09	x			x		
Z36	x							●●	●●	●●		151.4	5.96	148	5.83	134.9	5.31	70.20	2.76	77.61	3.06	x			x		

■ Machined sprocket ● Machined sprocket

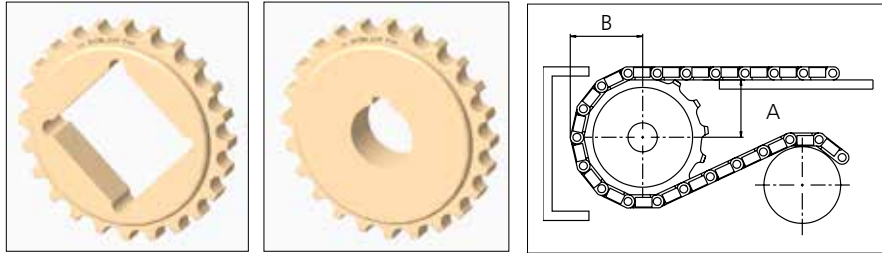

Non standard material and color: See uni Material and Color Overview.

### Nosebars Min. Dimensions

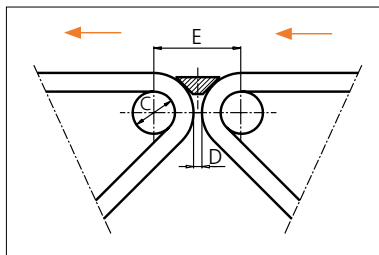
	<b>mm</b>	<b>in</b>
<b>C</b>	19.0	0.75
<b>D</b>	5.0	0.20
<b>E</b>	39.3	1.55

Other sprocket sizes are available upon request.  
 Two-part sprocket are available upon request.  
 Round bores are always delivered with keyway.  
 Other bore sizes are available upon request.  
 uni Retainer Rings: See uni Retainer Ring data sheet.  
 Width of tooth = 11.0 mm (0.43 in)  
 Width of sprocket = 20.0 mm (0.79 in)

Max load per sprocket shown does not take bore size into account.  
 Please also ensure that sufficient size shaft is chosen for corresponding load.

For correct sprocket position: See uni Assembly Instructions for uni M-OWL.  
 For more detailed sprocket information. contact Customer Service.

uni M-OWL M1 40% Open/170522



Expert advice, quality solutions and local service for all your belting needs  
[www.ammeraalbeltech.com](http://www.ammeraalbeltech.com)

**Ammeraal Beltech Modular A/S**  
 Hjulmagervej 21  
 DK-7100 Vejle

T +45 7572 3100  
 F +45 7572 3348  
 admin@unichains.com  
 www.unichains.com

This information is subject to alteration due to continuous development. Ammeraal Beltech will not be held liable for the incorrect use of the above stated information. This information replaces previous information. All activities performed and services rendered by Ammeraal Beltech are subject to general terms and conditions of sale and delivery, as applied by its operating companies.



# Plastic Modular Belt

Series **uni M-SNB** Type **M2 14%**

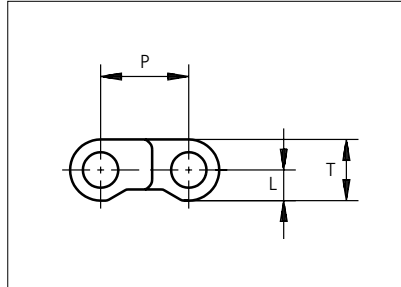

Straight running belt  
 Nominal pitch: 12.7 mm (0.50 in)  
 Surface type: Flat  
 Surface opening: 14%  
 Backflex radius: 20.0 mm (0.80 in)  
 Pin diameter: 5.0 mm (0.20 in)

Belt material & color	POM-D <b>B</b>	mm	in		mm	in
		P (Nominal)	12.7	0.50	T	8.8
Pin material & color	PP <b>B</b>	L	4.4	0.17	-	-

Non standard material and color: See uni Material and Color Overview.

Alternative pin and lock materials: G-lock: PA6.6 **N** Pin: PA6.6 **B** PE **W** PBT **LG** SS304 Endlock: PP **B** **W**  
 Lockpin: PBT **LG** PA6.6 **D** PP **W** PE **N**

Belt width		Permissible tensile force (Belt/pin material)		Belt weight (Belt/pin material)		*Min. No. drive sprocket per shaft	Number of wear strips (Min. No.)	
		POM-D/PP		POM-D/PP			**Carry (pcs)	**Return (pcs)
mm	in	N	lbf	kg/m	lb/ft			
77	3.0	1155	260	0.5	0.33	2	2	2
153	6.0	2295	516	1.0	0.65	2	2	2
229	9.0	3435	772	1.4	0.97	2	2	2
305	12.0	4575	1028	1.9	1.29	3	3	2
381	15.0	5715	1285	2.4	1.61	3	3	2
458	18.0	6870	1544	2.9	1.94	4	4	2
534	21.0	8010	1801	3.4	2.26	4	4	2
610	24.0	9150	2057	3.8	2.58	5	5	3
686	27.0	10290	2313	4.3	2.90	5	5	3
762	30.0	11430	2569	4.8	3.23	6	6	3
839	33.0	12585	2829	5.3	3.55	6	6	3
915	36.0	13725	3085	5.8	3.87	7	7	4

Additional standard belt widths are available in steps of 76.2 mm (3.00 in). Additional non-standard belt widths are available in steps of 12.7 mm (0.50 in).

1982	78.0	29730	6683	12.5	8.39	14	14	7
------	------	-------	------	------	------	----	----	---

Additional standard belt widths are available in steps of 76.2 mm (3.00 in). Additional non-standard belt widths are available in steps of 12.7 mm (0.50 in).

2972	117.0	44580	10022	18.7	12.58	20	20	10
------	-------	-------	-------	------	-------	----	----	----

General belt tolerance is +0/-0.4% at 23°C/73°F and 50% RH. For exact belt width contact Customer Service. Non standard belt width on request.

\*Max. Load per Drive Sprocket. Belt material: POM-D 1000 N (225 lbf).

\*\*Max. Spacing between wear strips. Carry: 152.0 mm (6.00 in); Return: 304.0 mm (12.00 in).

= Single Link



STANDARD

STRAIGHT RUNNING

PITCH 12.7 MM/0.50 IN

## Accessories

### Top/Bottom Insert

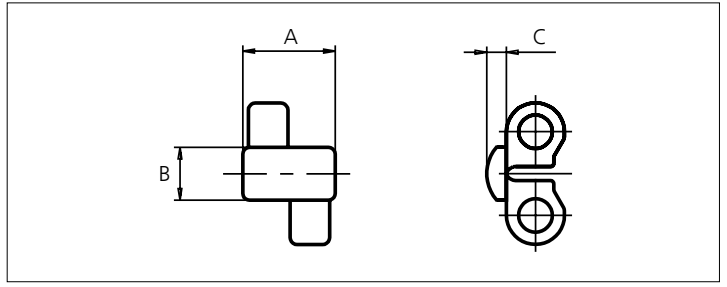

Type	Rubber material & color	A		B		C	
		mm	in	mm	in	mm	in
Rubber	01 	14.0	0.55	8.0	0.31	3.0	0.12

Rubber inserts can be assembled in any belt surface upon customer request.  
 Non Standard material and color: See uni Material and Color Overview.



## Sprocket

No. of teeth	Bore size							Overall diameter		Pitch-diameter		Hub-diameter		Dimension A		Dimension B		Single row/Two way	Molded	PAG LG
	Pilot bore	in		mm		mm														
	mm	25.0	25.4	30.0	31.8	38.1	40.0	mm	in	mm	in	mm	in	mm	in					
Z10	✓							41.5	1.63	41.6	1.64	28.0	1.10	16.1	0.63	25.0	0.98	✓	✓	
Z19	✓		●	●	●	●	■	79.0	3.11	78.1	3.07	65.0	2.56	34.1	1.34	43.0	1.69	✓	✓	
Z28	✓			●	●	●	■	116.2	4.57	115	4.53	65.0	2.56	52.2	2.06	61.1	2.41	✓	✓	
Z38	✓				●	●	■	157.4	6.20	156	6.14	100.0	2.95	72.5	2.85	81.3	3.20	✓	✓	

■ Molded sprocket

● Molded sprocket



Other sprocket sizes are available upon request.

Other bore sizes on sprockets are available upon request.

Round bores are always delivered with keyway.

Max. load per sprocket shown does not take bore size into account.

Please also ensure that sufficient size shaft is chosen for corresponding load.

Width of tooth = Single row: 7.0 mm (0.28 in)

Width of One-part sprocket = Single row: 20.0 mm (0.79 in)

## uni UltraClean Two-Part Sprocket

No. of teeth	Bore size			Overall diameter		Pitch-diameter		Hub-diameter		Dimension A		Dimension B		Single row/Two way	Molded	PAG W
	in	1.50	1.57													
	mm	38.1	40.0	mm	in	mm	in	mm	in	mm	in					
Z28		■	■	114.9	4.52	113.4	4.46	80.0	3.15	52.2	2.06	61.1	2.41	✓	✓	
Z38			■	155.5	6.12	153.8	6.06	126.0	4.96	72.5	2.85	81.3	3.20	✓	✓	

■ Moulded uni UltraClean TwoPart Sprocket

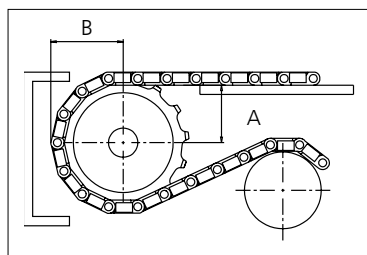

Nosebars Min. Dimensions

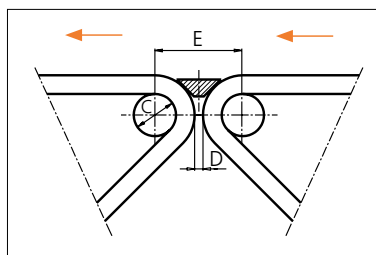

	mm	in
C	20.0	0.79
D	4.0	0.16
E	41.6	1.64

Width of UltraClean Two-part sprocket = Single row: 44.0 mm (1.73 in)

Width of UltraClean Two-part sprocket, tooth = Single row: 7.0 mm (0.28 in)

uni Retainer Rings: See uni Retainer Ring data sheet.

For correct sprocket position: See uni Assembly Instructions for uni M-SNB.

For more detailed sprocket information, contact Customer Service.



Conveyor Belts



Seamless Belts



Modular Belts



Timing Belts



Transmission Belts



Fabrication & service

Expert advice, quality solutions and local service for all your belting needs [www.ammeraalbeltech.com](http://www.ammeraalbeltech.com)

**Ammeraal Beltech Modular A/S**  
Hjulgagervej 21  
DK-7100 Vejle

T +45 7572 3100  
F +45 7572 3348  
admin@unichains.com  
www.unichains.com

This information is subject to alteration due to continuous development. Ammeraal Beltech will not be held liable for the incorrect use of the above stated information. This information replaces previous information. All activities performed and services rendered by Ammeraal Beltech are subject to general terms and conditions of sale and delivery, as applied by its operating companies.



# Plastic Modular Belt

Series **uni M-SNB** Type **M3 14%**

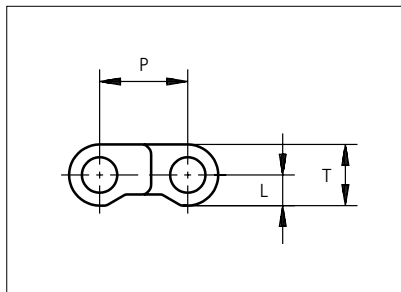
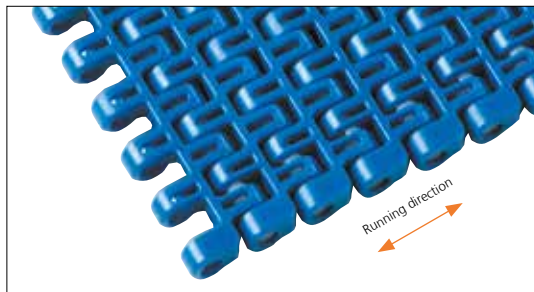

Straight running belt  
 Nominal pitch: 12.7 mm (0.50 in)  
 Surface type: Flat  
 Surface opening: 14%  
 Backflex radius: 20.0 mm (0.80 in)  
 Pin diameter: 5.00 mm (0.20 in)

Belt material & color	POM-D <b>B</b>	POM-LF <b>BR</b>	PP <b>W</b>						
					<b>mm</b>	<b>in</b>		<b>mm</b>	<b>in</b>
Pin material & color	PP <b>B</b>	PP <b>W</b>							
				<b>P (Nominal)</b>	12.7	0.50	<b>T</b>	8.8	0.35
				<b>L</b>	4.4	0.17	-	-	-

Non standard material and color: See uni Material and Color Overview.

Alternative pin and lock materials: Pin: PA6.6 **B** PE **W** PBT **LG** SS304 Endlock: PP **B** **W**  
 Lockpin: PBT **LG** PA6.6 **D** PP **B** **W** PE **N**

Belt width		Permissible tensile force (Belt/pin material)				Belt weight (Belt/pin material)				*Min. No. drive sprocket per shaft	Number of wear strips (Min. No.)	
		POM/PP		PP/PP		POM/PP		PP/PP			**Carry (pcs)	**Return (pcs)
mm	in	N	lbf	N	lbf	kg/m	lb/ft	kg/m	lb/ft			
77	3.0	1155	260	578	130	0.5	0.33	0.3	0.21	2	2	2
153	6.0	2295	516	1148	258	1.0	0.65	0.6	0.42	2	2	2
229	9.0	3435	772	1718	386	1.4	0.97	0.9	0.63	2	2	2
305	12.0	4575	1028	2288	514	1.9	1.29	1.3	0.84	3	3	2
381	15.0	5715	1285	2858	642	2.4	1.61	1.6	1.05	3	3	2
458	18.0	6870	1544	3435	772	2.9	1.94	1.9	1.26	4	4	2
534	21.0	8010	1801	4005	900	3.4	2.26	2.2	1.47	4	4	2
610	24.0	9150	2057	4575	1028	3.8	2.58	2.5	1.68	5	5	3
686	27.0	10290	2313	5145	1157	4.3	2.90	2.8	1.89	5	5	3
762	30.0	11430	2569	5715	1285	4.8	3.23	3.1	2.10	6	6	3
839	33.0	12585	2829	6293	1415	5.3	3.55	3.4	2.31	6	6	3
915	36.0	13725	3085	6863	1543	5.8	3.87	3.8	2.52	7	7	4

Additional standard belt widths are available in steps of 76.2 mm (3.00 in). Additional non-standard belt widths are available in steps of 12.7 mm (0.50 in).

1982	78.0	29730	6683	14865	3342	12.5	8.39	8.1	5.46	14	14	7
------	------	-------	------	-------	------	------	------	-----	------	----	----	---

Additional standard belt widths are available in steps of 76.2 mm (3.00 in). Additional non-standard belt widths are available in steps of 12.7 mm (0.50 in).

2972	117.0	44580	10022	22290	5011	18.7	12.58	12.2	8.19	20	20	10
------	-------	-------	-------	-------	------	------	-------	------	------	----	----	----

General belt tolerance is +0/-0.4% at 23°C/73°F and 50% RH. For exact belt width contact Customer Service. Non standard belt width on request.

\*Max. Load per Drive Sprocket. Belt material: POM-SLF 1000 N (225 lbf). PP 800 N (180 lbf), PE 800 N (180 lbf).

\*\*Max. Spacing between wear strips. Carry: 152.0 mm (6.00 in); Return: 304.0 mm (12.00 in).

= Single Link



STANDARD

STRAIGHT RUNNING

PITCH 12.7 MM/0.50 IN

## Accessories

### Top/Bottom Insert

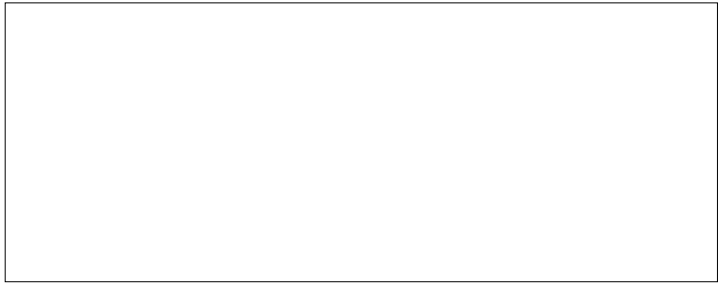

Type	Rubber material & color	A		B		C	
		mm	in	mm	in	mm	in
Rubber	01 	14.0	0.55	8.0	0.31	3.0	0.12

Rubber inserts can be assembled in any belt surface upon customer request.  
 Non Standard material and color: See uni Material and Color Overview.

### Sprocket

No. of teeth	Bore size							Overall diameter		Pitch-diameter		Hub-diameter		Dimension A		Dimension B		Single row/Two way	Molded	PAG LG
	Pilot bore																			
	mm	25.0	25.4	30.0	31.8	38.1	40.0	mm	in	mm	in	mm	in	mm	in	mm	in			
Z10	✓							41.5	1.63	41.6	1.64	28.0	1.10	16.1	0.63	25.0	0.98	✓	✓	
Z19	✓		●	●	●	●	■	79.0	3.11	78.1	3.07	65.0	2.56	34.1	1.34	43.0	1.69	✓	✓	
Z28	✓			●	●	●	■	116.2	4.57	115	4.53	65.0	2.56	52.2	2.06	61.1	2.41	✓	✓	
Z38	✓				●	●	■	157.4	6.20	156	6.14	100.0	2.95	72.5	2.85	81.3	3.20	✓	✓	

■ Molded sprocket

● Molded sprocket



Other sprocket sizes are available upon request.

Other bore sizes on sprockets are available upon request.

Round bores are always delivered with keyway.

Max. load per sprocket shown does not take bore size into account.

Please also ensure that sufficient size shaft is chosen for corresponding load.

Width of tooth = Single row: 7.0 mm (0.28 in)

Width of One-part sprocket = Single row: 20.0 mm (0.79 in)

### uni UltraClean Two-Part Sprocket

No. of teeth	Bore size			Overall diameter		Pitch-diameter		Hub-diameter		Dimension A		Dimension B		Single row/Two way	Molded	PAG W
	in	1.50	1.57													
	mm	38.1	40.0	mm	in	mm	in	mm	in	mm	in	mm	in			
Z28		■	■	114.9	4.52	113.4	4.46	80.0	3.15	52.2	2.06	61.1	2.41	✓	✓	
Z38			■	155.5	6.12	153.8	6.06	126.0	4.96	72.5	2.85	81.3	3.20	✓	✓	

■ Moulded uni UltraClean TwoPart Sprocket

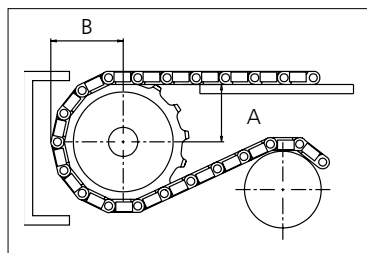

Nosebars Min. Dimensions

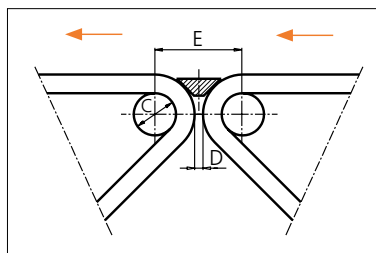

	mm	in
C	20.0	0.79
D	4.0	0.16
E	41.6	1.64

Width of UltraClean Two-part sprocket = Single row: 44.0 mm (1.73 in)

Width of UltraClean Two-part sprocket, tooth = Single row: 7.0 mm (0.28 in)

uni Retainer Rings: See uni Retainer Ring data sheet.

For correct sprocket position: See uni Assembly Instructions for uni M-SNB.

For more detailed sprocket information, contact Customer Service.



Conveyor Belts



Seamless Belts



Modular Belts



Timing Belts

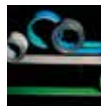

Transmission Belts



Fabrication & service

Expert advice, quality solutions and local service for all your belting needs [www.ammeraalbeltech.com](http://www.ammeraalbeltech.com)

**Ammeraal Beltech Modular A/S**  
Hjulmagervej 21  
DK-7100 Vejle

T +45 7572 3100  
F +45 7572 3348  
admin@unichains.com  
www.unichains.com

This information is subject to alteration due to continuous development. Ammeraal Beltech will not be held liable for the incorrect use of the above stated information. This information replaces previous information. All activities performed and services rendered by Ammeraal Beltech are subject to general terms and conditions of sale and delivery, as applied by its operating companies.



# Plastic Modular Belt

Serie **uni M-TTB** Type **37%**

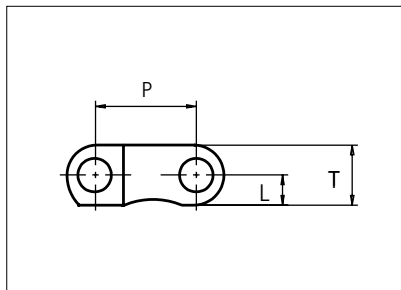
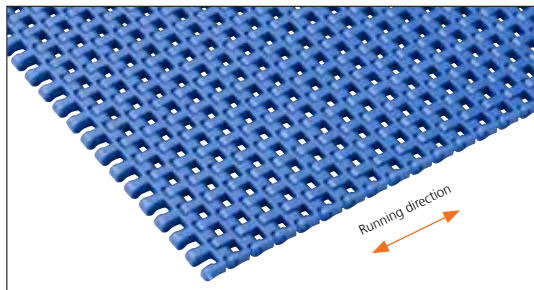

Straight Running  
 Nominal pitch: 12.7 mm (0.50 in)  
 Surface type: Flat  
 Surface opening: 37%  
 Backflex radius: 12.5 mm (0.49 in)  
 Min flex diameter (nosebar): 19.1 mm (0.75 in)  
 Pin diameter: 4.0 mm (0.16 in)

<b>Belt material &amp; color</b>	PP <span style="border: 1px solid black; padding: 0 2px;">W</span> <span style="border: 1px solid black; padding: 0 2px;">B</span>	POM-D <span style="border: 1px solid black; padding: 0 2px;">W</span> <span style="border: 1px solid black; padding: 0 2px;">B</span>		<b>mm</b>	<b>in</b>		<b>mm</b>	<b>in</b>	
<b>Pin material &amp; color</b>	PP <span style="border: 1px solid black; padding: 0 2px;">W</span>	PA6.6 <span style="border: 1px solid black; padding: 0 2px;">B</span>		<b>P (Nominal)</b>	12.7	0.50	<b>T</b>	7.5	0.29
				<b>L</b>	3.8	0.15	-	-	-

Non standard material and color: See uni Material and Color Overview.

Alternative pin material: PA6.6 B W

Belt width		Permissible tensile force (Belt/pin material)				Belt weight (Belt/pin material)				*Min No drive sprocket per haft	Number of wear strips (min no)	
		POM-D/PA6.6		PP/PP		POM-D/PA6.6		PP/PP			**Carry (pcs)	**Return (pcs)
mm	in	N	lbf	N	lbf	kg/m	lb/ft	kg/m	lb/ft			
77	3.0	1733	389	1001	225	0.4	0.30	0.3	0.22	2	2	2
154	6.1	3464	779	2002	450	0.9	0.60	0.6	0.43	2	2	2
231	9.1	5196	1168	3002	675	1.3	0.90	1.0	0.65	3	2	2
308	12.1	6927	1557	4003	900	1.8	1.20	1.3	0.87	4	3	2
385	15.2	8659	1947	5003	1125	2.2	1.50	1.6	1.09	4	3	2
462	18.2	10391	2336	6004	1350	2.7	1.80	1.9	1.30	5	4	2
539	21.2	12122	2725	7004	1575	3.1	2.10	2.3	1.52	6	4	2
616	24.2	13854	3114	8005	1799	3.6	2.40	2.6	1.74	7	5	3
693	27.3	15586	3504	9005	2024	4.0	2.70	2.9	1.96	7	5	3
770	30.3	17317	3893	10006	2249	4.5	3.00	3.2	2.17	8	6	3
847	33.3	19049	4282	11006	2474	4.9	3.30	3.6	2.39	9	6	3
924	36.4	20781	4671	12007	2699	5.4	3.60	3.9	2.61	10	7	4
1001	39.4	22512	5061	13007	2924	5.8	3.90	4.2	2.82	11	7	4

Additional standard belt widths are available in steps of 77.0 mm (3.03 in). Additional non-standard belt widths are available in steps of 12.7 mm (0.50 in).

2002	78.8	45045	10126	26026	5851	11.6	7.80	8.4	5.65	21	14	7
------	------	-------	-------	-------	------	------	------	-----	------	----	----	---

Additional standard belt widths are available in steps of 77.0 mm (3.03 in). Additional non-standard belt widths are available in steps of 12.7 mm (0.50 in).

2925	115.2	65813	14795	38025	8548	17.0	11.40	12.3	8.26	30	20	10
------	-------	-------	-------	-------	------	------	-------	------	------	----	----	----

General belt tolerance is +0/-0.4% at 23°C/73°F and 50% RH. For exact belt width contact Customer Service. Non standard belt width on request.

\*Max. Load per Drive Sprocket. Belt material: POM-D 1500 N (337 lbf), PP 1000 N (225 lbf).

\*\*Max. Spacing between wear strips, Carry: 152.0 mm (6.00 in); Return: 304.0 mm (12.00 in).

= Single Link



Member of Ammega Group.  
 ammega.com

STANDARD

STRAIGHT RUNNING

PITCH 12.7 MM/0.50 IN

## Accessories

### Rubber Top

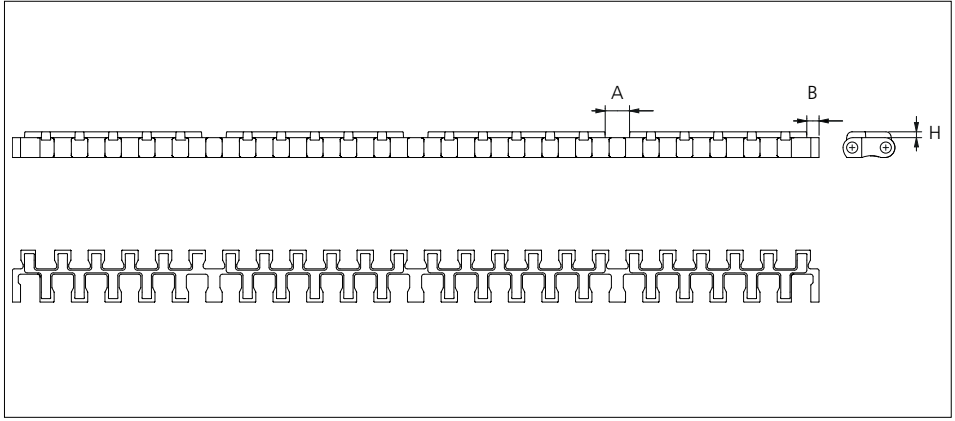
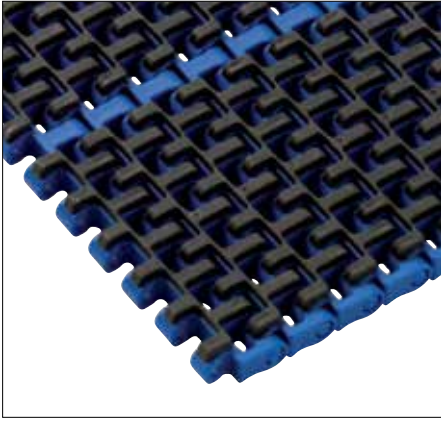

Type	Belt material & color	Rubber material & color	A		B		H		Link size	Width	
			mm	in	mm	in	mm	in		mm	in
Flat	PP <b>W</b>	03 <b>W</b>	9.2	0.36	4.6	0.18	2.2	0.09	K600	154.0	6.1
	PP <b>B</b>	03 <b>K</b>							K1200	308.0	12.1

Other Non Standard Rubber profiles: See uni Rubber Profile Overview.  
Backflex radius for Rubber Top: 28 mm (1.10 in).

## Accessories

### Flight

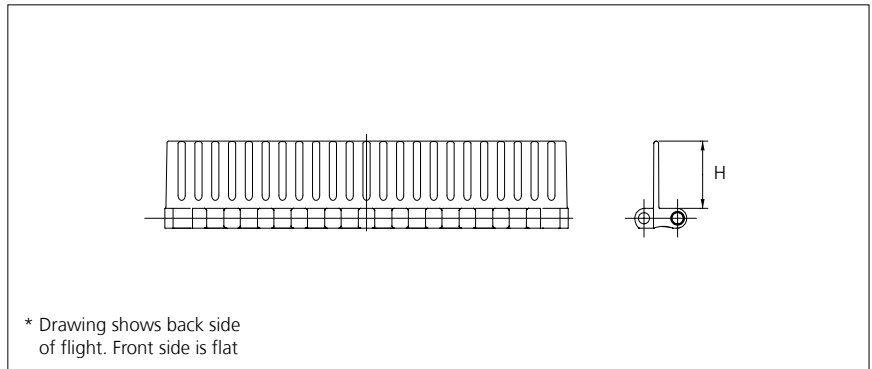
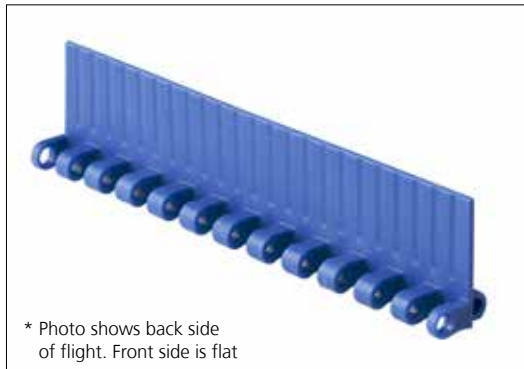

Type	Material & color	H		Link size	Width	
		mm	in		mm	in
Flat/Non Stick*	POM-D <b>W</b> <b>B</b>	25.4	1.00	K600	152.0	5.98

Non standard material and color: See uni Material and Color Overview.  
Minimum indent is for uni M-TTB flight 0 mm. Increment: 12.7 mm (0.50 in).



## Accessories

### Side Guard

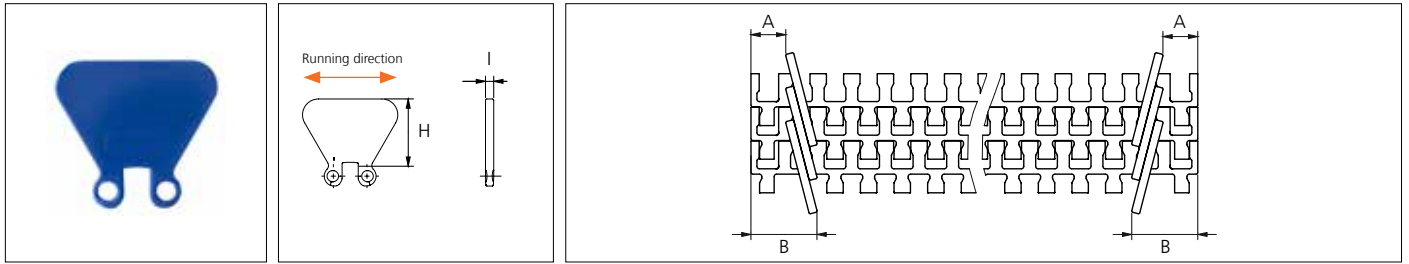

Type	Material & color	*A		B		H		I	
		mm	in	mm	in	mm	in	mm	in
Closed	POM-D <b>W</b> <b>B</b>	13.0	0.50	25.0	0.98	25.4	1.00	3.1	0.12

Non standard material and color: See uni Material and Color Overview.

\*Minimum indent is for uni M-TTB Side Guard. Increment: 12.7 mm (0.50 in).

## Accessories

### Roller

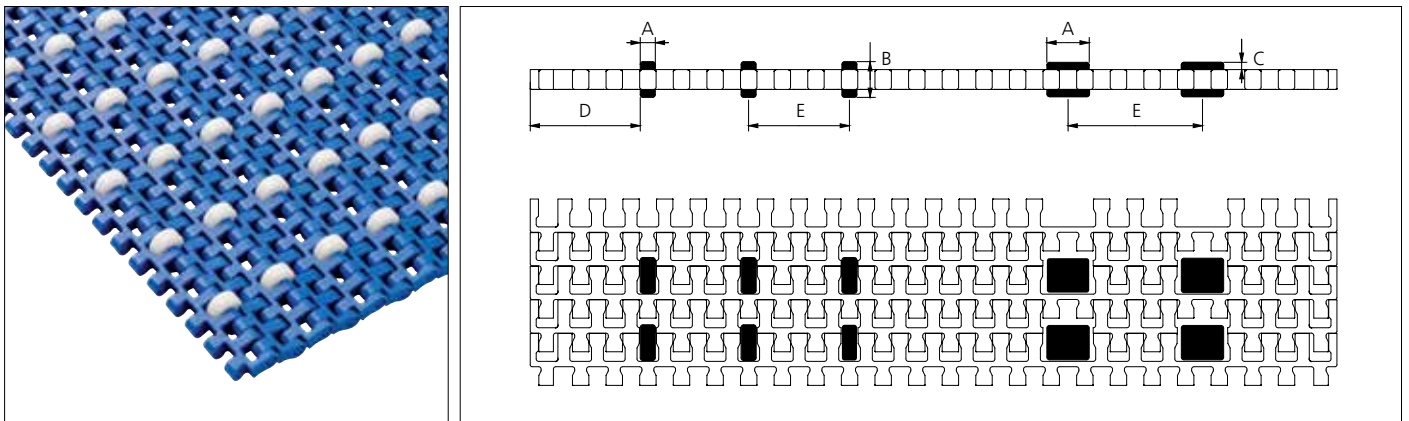

Type	Roller material & color	A		B		C		D (min)		E (min)	
		mm	in	mm	in	mm	in	mm	in	mm	in
Plastic	POM-D <b>W</b>	5.7	0.22	13.0	0.51	2.75	0.11	22.0	0.87	25.4	1.00
		16.0	0.62	13.0	0.51	2.75	0.11	22.0	0.87	38.1	1.50

Non standard Roller material and color: See uni Material and Color Overview.

## Accessories

### Non standard uni AmFlight for uni M-TTB

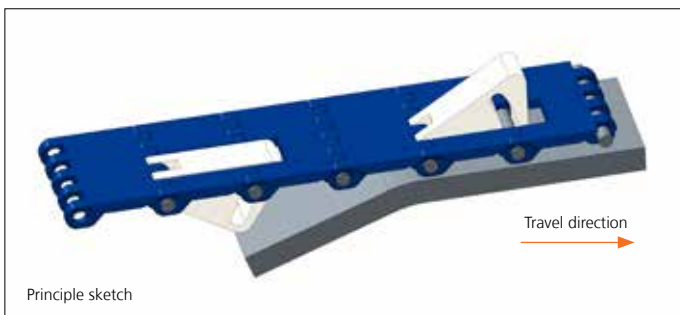

Other non standard option: See uni Amflight Overview.

## Sprocket

No. of teeth	Bore size										Overall diameter		Pitch-diameter		Hub-diameter		Dimension A		Dimension B		Single row/Two way	Molded	PA6 LG
	Pilot bore	in		mm		mm		mm		mm													
		0.75	0.78	0.98	1.00	1.18	1.25	1.50	1.57														
Z12	✓		●	●																		✓	✓
Z15	✓				●	●																✓	✓
Z19																						✓	✓
Z24	✓			●	●	●	●	●	●	●	●	●	●	●	●	●	●	●	●	●	●	✓	✓
Z36	✓																					✓	✓

### Molded sprocket

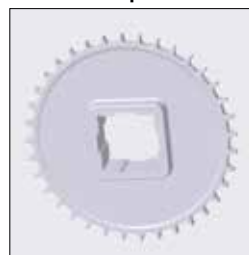

Other sprocket sizes are available upon request.  
 Other bore sizes on sprockets are available upon request.  
 Max. load per sprocket shown does not take bore size into account.  
 Please also ensure that sufficient size shaft is chosen for corresponding load.  
 Width of tooth : 6.5 mm (0.26 in)  
 Width of One-part sprocket : 25.0 mm (0.98 in)

## uni UltraClean Two-Part Sprocket

No. of teeth	Bore size		Overall diameter		Pitch-diameter		Hub-diameter		Dimension A		Dimension B		Single row/One way	Moulded	PA6 W
	in	1.57													
	mm	40.0	mm	in	mm	in	mm	in	mm	in	mm	in			
Z24		■	102.1	4.02	97.3	3.83	80.0	3.15	44.5	1.75	52.4	2.06	✓	✓	
Z36		■	152.3	6.0	145.7	5.74	126.0	4.96	68.8	2.71	76.6	3.01	✓	✓	

### Moulded uni UltraClean TwoPart Sprocket

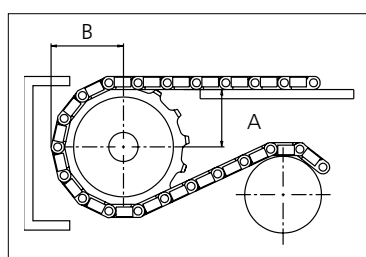

### Nosebars Min. Dimensions

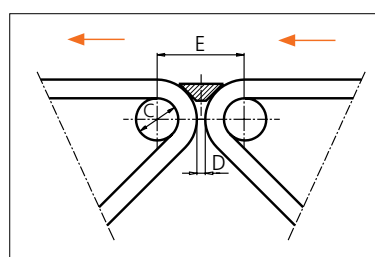

	mm	in
C	19.0	0.75
D	4.0	0.16
E	40.6	1.60

Width of UltraClean Two-part sprocket: 44.0 mm (1.73 in)  
 Width of UltraClean Two-part sprocket, tooth: 6.5 mm (0.26 in)

uni Retainer Rings: See uni Retainer Ring data sheet.  
 For correct sprocket position: See uni Assembly Instructions for uni M-TTB.  
 For more detailed sprocket information. contact Customer Service.



Expert advice, quality solutions and local service for all your belting needs  
[www.ammeraalbeltech.com](http://www.ammeraalbeltech.com)

Ammeraal Beltech Modular A/S  
 Hjulmagervej 21  
 DK-7100 Vejle

T +45 7572 3100  
 F +45 7572 3348  
 admin@unichains.com  
[www.unichains.com](http://www.unichains.com)

This information is subject to alteration due to continuous development. Ammeraal Beltech will not be held liable for the incorrect use of the above stated information. This information replaces previous information. All activities performed and services rendered by Ammeraal Beltech are subject to general terms and conditions of sale and delivery, as applied by its operating companies.



# Plastic Modular Belt

Serie **uni M-TTB** Type **37% CS**

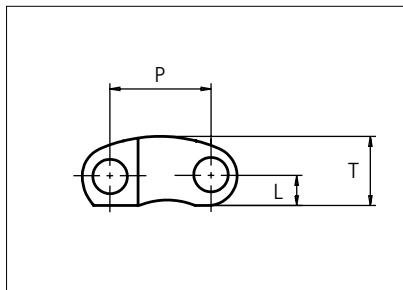
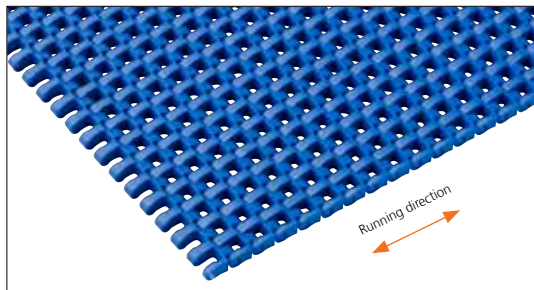

Straight Running  
 Nominal pitch: 12.7 mm (0.50 in)  
 Surface type: Curved  
 Surface opening: 37%  
 Backflex radius: 12.5 mm (0.49 in)  
 Min flex diameter (nosebar): 19.1 mm (0.75 in)  
 Pin diameter: 4.0 mm (0.16 in)  
 Curved surface makes perfect circle when 25.4 mm (1.00 in) flex diameter is applied.

<b>Belt material &amp; color</b>	PP <b>B</b>	POM-D <b>B</b>		<b>mm</b>	<b>in</b>		<b>mm</b>	<b>in</b>	
<b>Pin material &amp; color</b>	PP <b>W</b>	PBT <b>LG</b>		<b>P (Nominal)</b>	12.7	0.50	<b>T</b>	8.8	0.35
				<b>L</b>	3.8	0.15	-	-	-

Non standard material and color: See uni Material and Color Overview.

Alternative pin material: PA6.6 **B**

Belt width		Permissible tensile force (Belt/pin material)				Belt weight (Belt/pin material)				*Min No drive sprocket per haft	Number of wear strips (min no)	
		POM-D/PBT		PP/PP		POM-D/PBT		PP/PP			**Carry (pcs)	**Return (pcs)
mm	in	N	lbf	N	lbf	kg/m	lb/ft	kg/m	lb/ft			
77	3.0	1733	389	1001	225	0.5	0.32	0.3	0.22	2	2	2
154	6.1	3464	779	2002	450	1.0	0.64	0.6	0.43	2	2	2
231	9.1	5196	1168	3002	675	1.4	0.96	1.0	0.65	3	2	2
308	12.1	6927	1557	4003	900	1.9	1.28	1.3	0.87	4	3	2
385	15.2	8659	1947	5003	1125	2.4	1.60	1.6	1.09	4	3	2
462	18.2	10391	2336	6004	1350	2.9	1.92	1.9	1.30	5	4	2
539	21.2	12122	2725	7004	1575	3.3	2.24	2.3	1.52	6	4	2
616	24.2	13854	3114	8005	1799	3.8	2.57	2.6	1.74	7	5	3
693	27.3	15586	3504	9005	2024	4.3	2.89	2.9	1.96	7	5	3
770	30.3	17317	3893	10006	2249	4.8	3.21	3.2	2.17	8	6	3
847	33.3	19049	4282	11006	2474	5.2	3.53	3.6	2.39	9	6	3
924	36.4	20781	4671	12007	2699	5.7	3.85	3.9	2.61	10	7	4
1001	39.4	22512	5061	13007	2924	6.2	4.17	4.2	2.82	11	7	4

Additional standard belt widths are available in steps of 77.0 mm (3.03 in). Additional non-standard belt widths are available in steps of 12.7 mm (0.50 in).

2002	78.8	45045	10126	26026	5851	12.4	8.34	8.4	5.65	21	14	7
------	------	-------	-------	-------	------	------	------	-----	------	----	----	---

Additional standard belt widths are available in steps of 77.0 mm (3.03 in). Additional non-standard belt widths are available in steps of 12.7 mm (0.50 in).

1925	75.8	43313	9737	25025	5626	11.9	8.02	8.1	5.43	20	13	7
------	------	-------	------	-------	------	------	------	-----	------	----	----	---

General belt tolerance is +0/-0.4% at 23°C/73°F and 50% RH. For exact belt width contact Customer Service. Non standard belt width on request.

\*Max. Load per Drive Sprocket. Belt material: PP 1000 N (225 lbf)

\*\*Max. Spacing between wear strips. Carry: 152.0 mm (6.00 in); Return: 304.0 mm (12.00 in).

= Single Link



Member of Ammega Group.  
 ammega.com

STANDARD

STRAIGHT RUNNING

PITCH 12.7 MM/0.50 IN

## Accessories

### Rubber Top

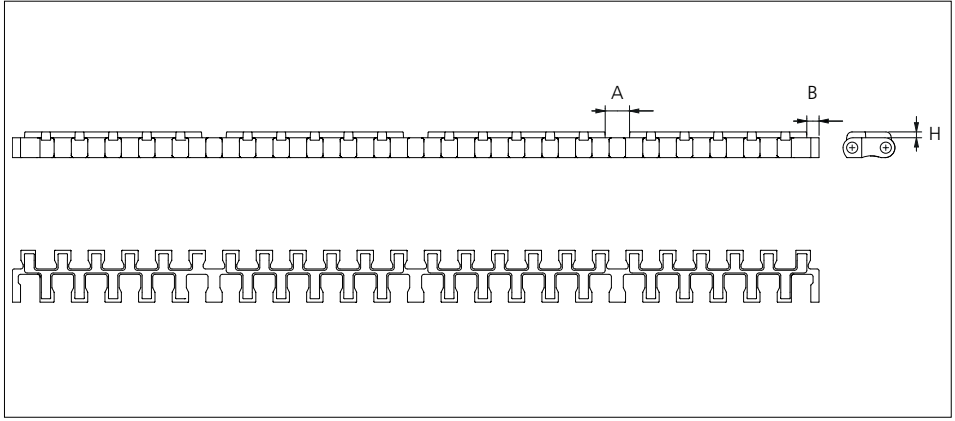
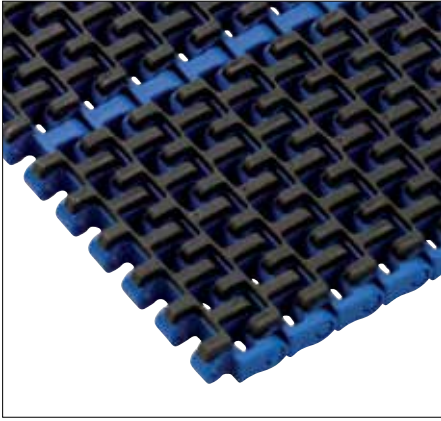

Type	Belt material & color	Rubber material & color	A		B		H		Link size	Width	
			mm	in	mm	in	mm	in		mm	in
Flat	PP <b>W</b>	03 <b>W</b>	9.2	0.36	4.6	0.18	2.2	0.09	K600	154.0	6.1
	PP <b>B</b>	03 <b>K</b>							K1200	308.0	12.1

Other Non Standard Rubber profiles: See uni Rubber Profile Overview.

## Accessories

### Flight

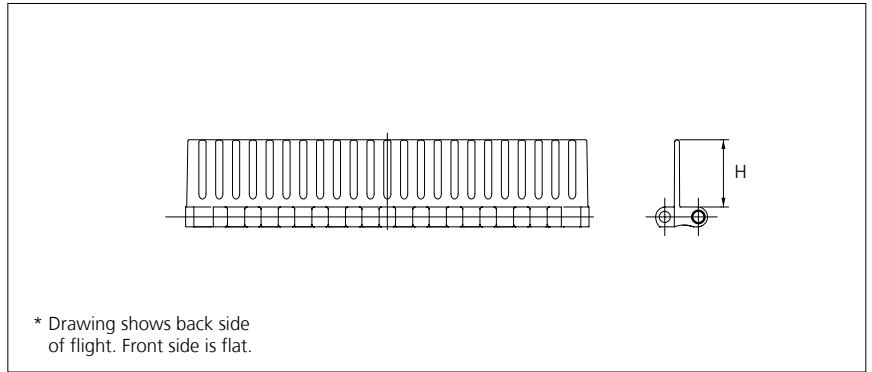
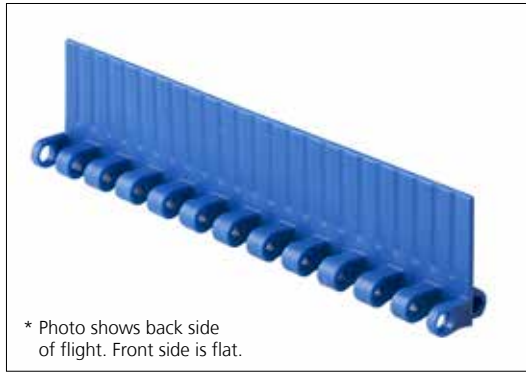

Type	Material & color	H		Link size	Width	
		mm	in		mm	in
Flat/Non Stick*	POM-D <b>W</b> <b>B</b>	25.4	1.00	K600	152.0	5.98

Non standard material and color: See uni Material and Color Overview.

Minimum indent is for uni M-TTB flight 0 mm. Increment: 12.7 mm (0.50 in).

## Accessories

### Side Guard

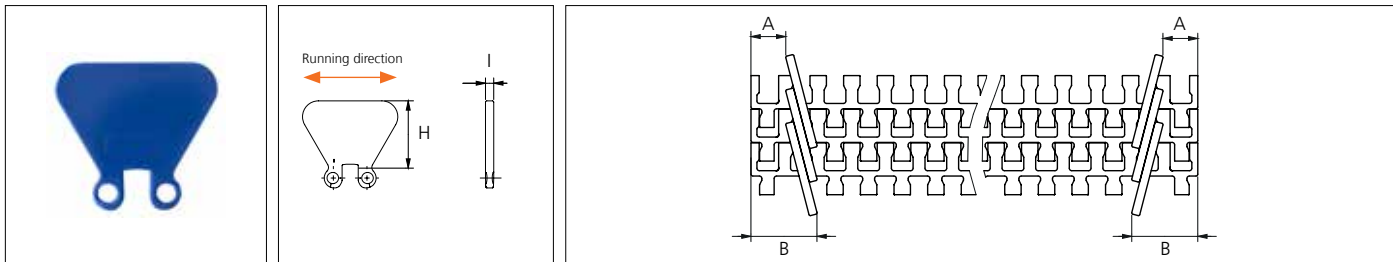

Type	Material & color	*A		B		H		I	
		mm	in	mm	in	mm	in	mm	in
Closed	POM-D <b>W</b> <b>B</b>	13.0	0.50	25.0	0.98	25.4	1.00	3.1	0.12

Non standard material and color: See uni Material and Color Overview.

\*Minimum indent is for uni M-TTB Side Guard. Increment: 12.7 mm (0.50 in).

## Accessories

### Roller

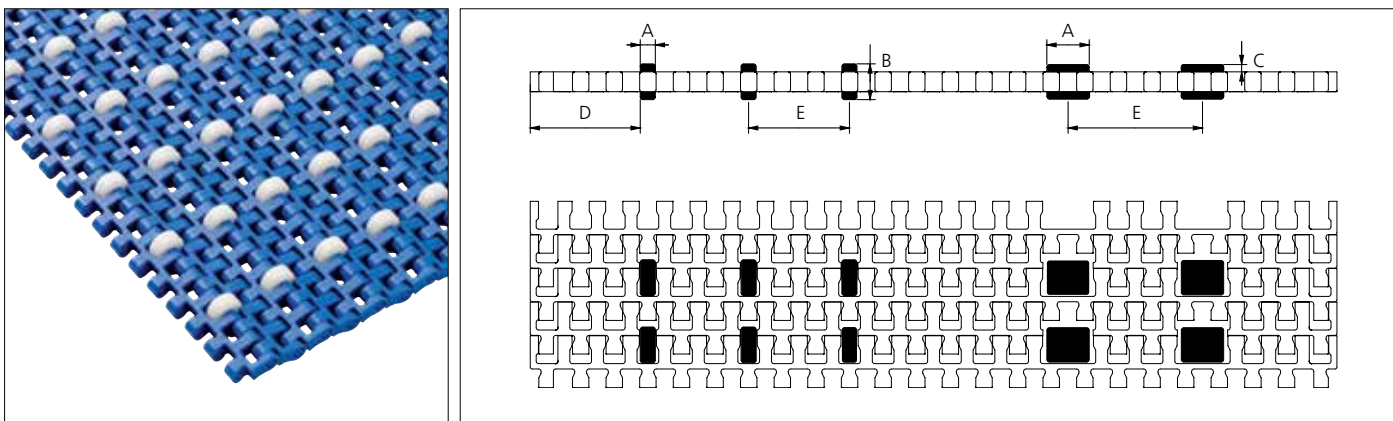

Type	Roller material & color	A		B		C		D (min)		E (min)	
		mm	in	mm	in	mm	in	mm	in	mm	in
Plastic	POM-D <b>W</b>	5.7	0.22	13.0	0.51	2.75	0.11	22.0	0.87	25.4	1.00
		16.0	0.62	13.0	0.51	2.75	0.11	22.0	0.87	38.1	1.50

Non standard Roller material and color: See uni Material and Color Overview.

## Sprocket

No. of teeth	Bore size										Overall diameter		Pitch-diameter		Hub-diameter		Dimension A		Dimension B		Single row/Two way	Molded	PA6 LG
	Pilot bore	in	0.75	0.78	0.98	1.00	1.18	1.25	1.50	1.57													
	mm	19.1	20.0	25.0	25.4	30.0	31.8	38.1	40.0	mm	in	mm	in	mm	in	mm	in	mm	in				
Z12	✓		●	●							52.0	2.05	49.1	1.93	40.0	1.57	20.0	0.79	28.7	1.12	✓	✓	
Z15	✓				● 2	● 1					64.6	2.54	61.1	2.41	152.0 244.0	12.04 21.74	26.1	1.03	34.9	1.37	✓	✓	
Z19									■		80.1	3.15	77.2	3.04	70.0	2.76	34.3	1.35	43.0	1.69	✓	✓	
Z24	✓			● 1	● 1	● 1	● 1	● 1	■ 2	■ 2	102.1	4.02	97.3	3.83	159.0 272.0	12.32 22.83	44.5	1.75	53.2	2.09	✓	✓	
Z36	✓								■	■	152.3	6.01	145.7	5.74	72.0	2.83	68.8	2.71	77.6	3.05	✓	✓	

### Molded sprocket



Other sprocket sizes are available upon request.  
 Other bore sizes on sprockets are available upon request.  
 Max. load per sprocket shown does not take bore size into account.  
 Please also ensure that sufficient size shaft is chosen for corresponding load.  
 Width of tooth : 6.5 mm (0.26 in)  
 Width of One-part sprocket : 25.0 mm (0.98 in)

## uni UltraClean Two-Part Sprocket

No. of teeth	Bore size		Overall diameter		Pitch-diameter		Hub-diameter		Dimension A		Dimension B		Single row/One way	Molded	PA6 W
	in	1.57													
	mm	40.0	mm	in	mm	in	mm	in	mm	in	mm	in			
Z24		■	102.1	4.02	97.3	3.83	80.0	3.15	44.5	1.75	52.4	2.06	✓	✓	
Z36		■	152.3	6.0	145.7	5.74	126.0	4.96	68.8	2.71	76.6	3.01	✓	✓	

### Moulded uni UltraClean TwoPart Sprocket

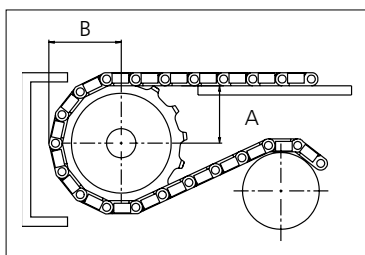

### Nosebars Min. Dimensions

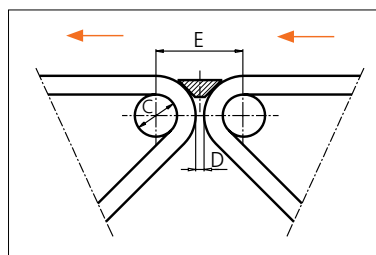

	mm	in
C	19.0	0.75
D	4.0	0.16
E	40.6	1.60

Width of UltraClean Two-part sprocket: 44.0 mm (1.73 in)  
 Width of UltraClean Two-part sprocket, tooth: 6.5 mm (0.26 in)

uni Retainer Rings: See uni Retainer Ring data sheet.  
 For correct sprocket position: See uni Assembly Instructions for uni M-TTB.  
 For more detailed sprocket information, contact Customer Service.



Conveyor Belts



Seamless Belts



Modular Belts



Timing Belts



Transmission Belts



Fabrication & service

Expert advice, quality solutions and local service for all your belting needs  
[www.ammeraalbeltech.com](http://www.ammeraalbeltech.com)

Ammeraal Beltech Modular A/S  
 Hjulmagervej 21  
 DK-7100 Vejle

T +45 7572 3100  
 F +45 7572 3348  
[admin@unichains.com](mailto:admin@unichains.com)  
[www.unichains.com](http://www.unichains.com)

This information is subject to alteration due to continuous development. Ammeraal Beltech will not be held liable for the incorrect use of the above stated information. This information replaces previous information. All activities performed and services rendered by Ammeraal Beltech are subject to general terms and conditions of sale and delivery, as applied by its operating companies.



# Plastic Modular Belt

Series **uni M-QNB** Type **NS**

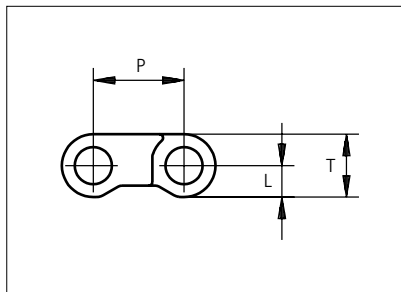
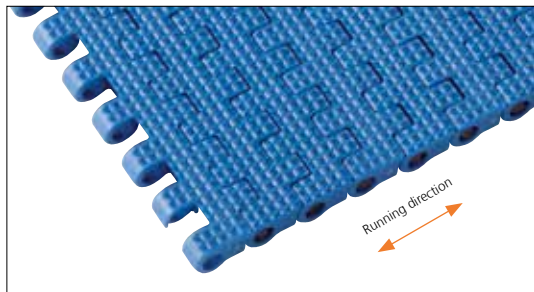

Straight running belt  
 Nominal pitch: 12.7 mm (0.50 in)  
 Surface type: Flat  
 Surface opening: Closed  
 Backflex radius: 20.0 mm (0.80 in)  
 Pin diameter: 5.0 mm (0.20 in)

Belt material & color	POM-SLF <b>B</b>	PE <b>B</b>	mm	in	mm	in		
	Pin material & color	PP <b>B</b>	PE <b>N</b>	<b>P (Nominal)</b>	12.7	0.50	<b>T</b>	8.8
<b>L</b>		4.4	0.17	-	-	-		

Non standard material and color: See uni Material and Color Overview.

Alternative pin and lock materials: Lockpin: PBT **LG** PA6.6 **N** **D** PP **B** PE **N**

Belt width		Permissible tensile force (Belt/pin material)				Belt weight (Belt/pin material)				*Min. No. drive sprocket per shaft	Number of wear strips (Min. No.)	
		POM-SLF/PP		PE/PE		POM-SLF/PP		PE/PE			**Carry (pcs)	**Return (pcs)
mm	in	N	lbf	N	lbf	kg/m	lb/ft	kg/m	lb/ft			
77	3.0	1463	329	616	138	0.6	0.42	0.5	0.31	2	2	2
153	6.0	2907	653	1224	275	1.3	0.84	0.9	0.61	2	2	2
229	9.0	4351	978	1832	412	1.9	1.26	1.4	0.91	3	2	2
305	12.0	5795	1303	2440	549	2.5	1.68	1.8	1.21	4	3	2
382	15.0	7258	1632	3056	687	3.1	2.11	2.3	1.51	4	3	2
458	18.0	8702	1956	3664	824	3.8	2.52	2.7	1.82	5	4	2
534	21.0	10146	2281	4272	960	4.4	2.94	3.2	2.12	6	4	2
610	24.0	11590	2605	4880	1097	5.0	3.36	3.6	2.42	7	5	3
687	27.0	13053	2934	5496	1236	5.6	3.79	4.1	2.72	7	5	3
763	30.0	14497	3259	6104	1372	6.3	4.20	4.5	3.03	8	6	3
839	33.0	15941	3584	6712	1509	6.9	4.62	5.0	3.33	9	6	3
915	36.0	17385	3908	7320	1646	7.5	5.04	5.4	3.63	10	7	4
992	39.1	18848	4237	7936	1784	8.1	5.47	5.9	3.93	10	7	4

Additional standard belt widths are available in steps of 76.3 mm (3.00 in.) Additional non-standard belt widths are available in steps of 38.1 mm (1.50 in.)

1983	78.1	37677	8470	15864	3566	16.3	10.93	11.7	7.86	20	14	7
------	------	-------	------	-------	------	------	-------	------	------	----	----	---

Additional standard belt widths are available in steps of 76.3 mm (3.00 in.) Additional non-standard belt widths are available in steps of 38.1 mm (1.50 in.)

2974	117.1	56506	12703	23792	5348	24.4	16.39	17.5	11.79	30	20	10
------	-------	-------	-------	-------	------	------	-------	------	-------	----	----	----

General belt tolerance is +0/-0.4% at 23°C/73°F and 50% RH. For exact belt width contact Customer Service. Non standard belt width on request.

\*Max. Load per Drive Sprocket. Belt material: POM-SLF 1000 N (225 lbf), PE 800 N (180 lbf)

\*\*Max. Spacing between wear strips, Carry: 152.0 mm (6.00 in); Return: 304.0 mm (12.00 in)

= Single Link



STANDARD

STRAIGHT RUNNING

PITCH 12.7 MM/0.50 IN

## Sprocket

No. of teeth	Bore size									Overall diameter		Pitch-diameter		Hub-diameter		Dimension A		Dimension B		Single row/Two way	Molded	PA6 LG
	Pilot bore	in		0.78		1.00		1.18														
	mm	18.0	25.4	30.0	31.8	38.1	40.0	60.0	mm	in	mm	in	mm	in	mm	in	mm	in				
Z10	✓	●							41.3	1.63	41.1	1.62	28.0	1.10	15.2	0.60	25	0.98	✓	✓		
Z19	✓		●	●	●	■	●		78.3	3.06	77.2	3.04	65.0	2.56	33.7	1.33	43	1.69	✓	✓		
Z28	✓		●	●	●	■	■		114.9	4.52	113.4	4.46	65.0	2.56	52	2.05	61.1	2.41	✓	✓		
Z28							■		114.9	4.52	113.4	4.46	100.0	3.93	52	2.05	61.1	2.41	✓	✓		
Z38	✓				●	●	●		155.5	6.12	153.8	6.06	75.0	2.95	72.2	2.84	81.3	3.20	✓	✓		

### Molded sprocket



### Molded sprocket



Other sprocket sizes are available upon request.

Other bore sizes on sprockets are available upon request.

Round bores are always delivered with keyway.

Max. load per sprocket shown does not take bore size into account.

Please also ensure that sufficient size shaft is chosen for corresponding load.

Width of tooth = Single row: 7.0 mm (0.28 in)

Width of One-part sprocket = Single row: 20.0 mm (0.79 in)

## uni UltraClean Two-Part Sprocket

No. of teeth	Bore size			Overall diameter		Pitch-diameter		Hub-diameter		Dimension A		Dimension B		Single row/Two way	Moulded	PA6 W
	in	1.50	1.57													
	mm	38.1	40.0	mm	in	mm	in	mm	in	mm	in	mm	in			
Z28		■	■	114.9	4.52	113.4	4.46	80.0	3.15	52.0	2.05	61.1	2.41	✓	✓	
Z38			■	155.5	6.12	153.8	6.06	126.0	4.96	72.2	2.84	81.3	3.20	✓	✓	

### Moulded uni UltraClean TwoPart Sprocket

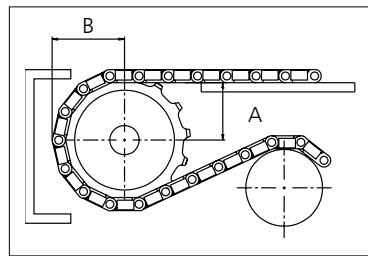

### Nosebars Min. Dimensions

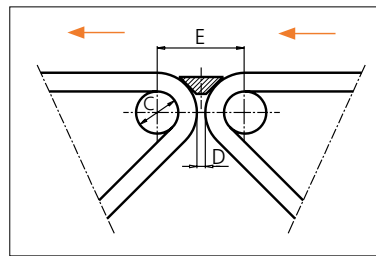

	mm	in
C	20.0	0.79
D	4.0	0.16
E	41.6	1.64

Width of UltraClean Two-part sprocket = Single row: 44.0 mm (1.73 in)

Width of UltraClean Two-part sprocket, tooth = Single row: 7.0 mm (0.28 in)

uni Retainer Rings: See uni Retainer Ring data sheet.

For correct sprocket position: See uni Assembly Instructions for uni M-QNB.

For more detailed sprocket information. contact Customer Service.



Conveyor Belts



Seamless Belts



Modular Belts



Timing Belts



Transmission Belts



Fabrication & service

Expert advice, quality solutions and local service for all your belting needs  
[www.ammeraalbeltech.com](http://www.ammeraalbeltech.com)

**Ammeraal Beltech Modular A/S**  
 Hjulmagervej 21  
 DK-7100 Vejle

T +45 7572 3100  
 F +45 7572 3348  
 admin@unichains.com  
 www.unichains.com

This information is subject to alteration due to continuous development. Ammeraal Beltech will not be held liable for the incorrect use of the above stated information. This information replaces previous information. All activities performed and services rendered by Ammeraal Beltech are subject to general terms and conditions of sale and delivery, as applied by its operating companies.





# Plastic Modular Belt

Series **uni M-QNB** Type **Vacuum**

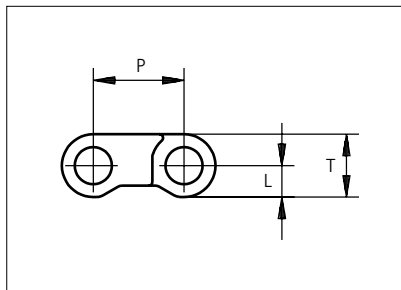
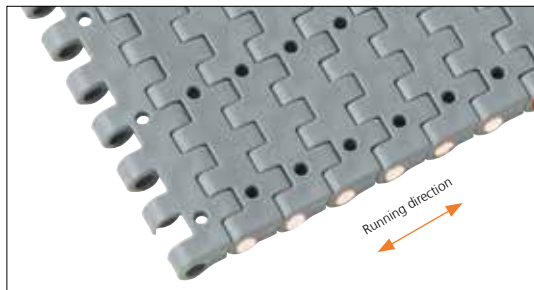

Straight running belt  
 Nominal pitch: 12.7 mm (0.50 in)  
 Surface type: Flat  
 Surface opening: Closed  
 Backflex radius: 20.0 mm (0.80 in)  
 Pin diameter: 5.0 mm (0.20 in)

**Vacuum holes: ø3.2 mm (0.12 in)**

Recommended belt material & color	PP <b>G</b>	mm	in		mm	in
		<b>P (Nominal)</b>	12.7	0.50	<b>T</b>	8.8
Recommended pin material & color	PP <b>W</b>	L	4.4	0.17	-	-

Non standard material and color: See uni Material and Color Overview.

Alternative pin and lock materials: Lockpin: PBT **LG** PA6.6 **N** **D** PP **B** PE **N**

Belt width		Permissible tensile force (Belt/pin material)		Belt weight (Belt/pin material)		*Min. No. drive sprocket per shaft	Number of wear strips (Min. No.)	
		PP/PP		PP/PP			**Carry (pcs)	**Return (pcs)
mm	in	N	lbf	kg/m	lb/ft			
77	3.0	1001	225	0.5	0.32	2	2	2
153	6.0	1989	447	0.9	0.63	2	2	2
229	9.0	2977	669	1.4	0.94	3	2	2
305	12.0	3965	891	1.9	1.25	4	3	2
382	15.0	4966	1116	2.3	1.57	4	3	2
458	18.0	5954	1338	2.8	1.88	5	4	2
534	21.0	6942	1561	3.3	2.19	6	4	2
610	24.0	7930	1783	3.7	2.50	7	5	3
687	27.0	8931	2008	4.2	2.82	7	5	3
763	30.0	9919	2230	4.7	3.13	8	6	3
839	33.0	10907	2452	5.1	3.44	9	6	3
915	36.0	11895	2674	5.6	3.75	10	7	4
992	39.1	12896	2899	6.1	4.07	10	7	4

Additional standard belt widths are available in steps of 76.3 mm (3.00 in.) Additional non-standard belt widths are available in steps of 38.1 mm (1.50 in.)

1983	78.1	25779	5795	12.1	8.13	20	14	7
------	------	-------	------	------	------	----	----	---

Additional standard belt widths are available in steps of 76.3 mm (3.00 in.) Additional non-standard belt widths are available in steps of 38.1 mm (1.50 in.)

2974	117.1	38662	8691	18.1	12.19	30	20	10
------	-------	-------	------	------	-------	----	----	----

General belt tolerance is +0/-0.4% at 23°C/73°F and 50% RH. For exact belt width contact Customer Service. Non standard belt width on request.

\*Max. Load per Drive Sprocket. Belt material: PP 800 N (180 lbf).

\*\*Max. Spacing between wear strips, Carry: 152.0 mm (6.00 in); Return: 304.0 mm (12.00 in)

= Single Link



NON STANDARD

STRAIGHT RUNNING

PITCH 12.7 MM/0.50 IN

## Sprocket

No. of teeth	Bore size									Overall diameter		Pitch-diameter		Hub-diameter		Dimension A		Dimension B		Single row/Two way	Molded	LG
	Pilot bore	in		mm		mm		in														
		mm	18.0	25.4	30.0	31.8	38.1	40.0	60.0	mm	in	mm	in	mm	in	mm	in	mm	in			
Z10	✓	●							41.3	1.63	41.1	1.62	28.0	1.10	15.2	0.60	25	0.98	✓	✓		
Z19	✓	●	●	●	●	■	●		78.3	3.06	77.2	3.04	65.0	2.56	33.7	1.33	43	1.69	✓	✓		
Z28	✓	●	●	●	●	■	●		114.9	4.52	113.4	4.46	65.0	2.56	52	2.05	61.1	2.41	✓	✓		
Z28								■	114.9	4.52	113.4	4.46	100.0	3.93	52	2.05	61.1	2.41	✓	✓		
Z38	✓				●	●	●		155.5	6.12	153.8	6.06	75.0	2.95	72.2	2.84	81.3	3.20	✓	✓		

### Molded sprocket



### Molded sprocket



Other sprocket sizes are available upon request.

Other bore sizes on sprockets are available upon request.

Round bores are always delivered with keyway.

Max. load per sprocket shown does not take bore size into account.

Please also ensure that sufficient size shaft is chosen for corresponding load.

Width of tooth = Single row: 7.0 mm (0.28 in)

Width of One-part sprocket = Single row: 20.0 mm (0.79 in)

## uni UltraClean Two-Part Sprocket

No. of teeth	Bore size			Overall diameter		Pitch-diameter		Hub-diameter		Dimension A		Dimension B		Single row/Two way	Moulded	W
	in	1.50	1.57													
	mm	38.1	40.0	mm	in	mm	in	mm	in	mm	in	mm	in			
Z28		■	■	114.9	4.52	113.4	4.46	80.0	3.15	52.0	2.05	61.1	2.41	✓	✓	
Z38			■	155.5	6.12	153.8	6.06	126.0	4.96	72.2	2.84	81.3	3.20	✓	✓	

### Moulded uni UltraClean TwoPart Sprocket

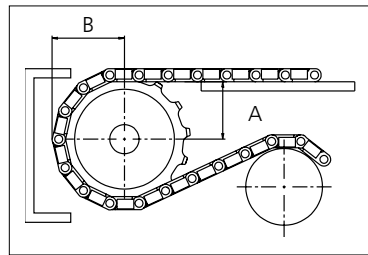

### Nosebars Min. Dimensions

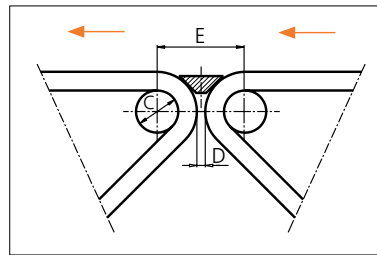

	mm	in
C	20.0	0.79
D	4.0	0.16
E	41.6	1.64

Width of UltraClean Two-part sprocket = Single row: 44.0 mm (1.73 in)

Width of UltraClean Two-part sprocket, tooth = Single row: 7.0 mm (0.28 in)

uni Retainer Rings: See uni Retainer Ring data sheet.

For correct sprocket position: See uni Assembly Instructions for uni M-QNB.

For more detailed sprocket information. contact Customer Service.

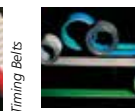

Expert advice, quality solutions and local service for all your belting needs [www.ammeraalbeltech.com](http://www.ammeraalbeltech.com)

**Ammeraal Beltech Modular A/S**  
Hjulmagervej 21  
DK-7100 Vejle

T +45 7572 3100  
F +45 7572 3348  
admin@unichains.com  
www.unichains.com

This information is subject to alteration due to continuous development. Ammeraal Beltech will not be held liable for the incorrect use of the above stated information. This information replaces previous information. All activities performed and services rendered by Ammeraal Beltech are subject to general terms and conditions of sale and delivery, as applied by its operating companies.



# Plastic Modular Belt

Series **uni M-QNB** Type **C**

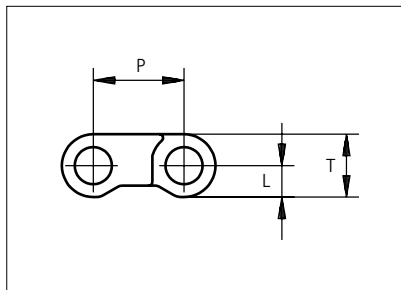
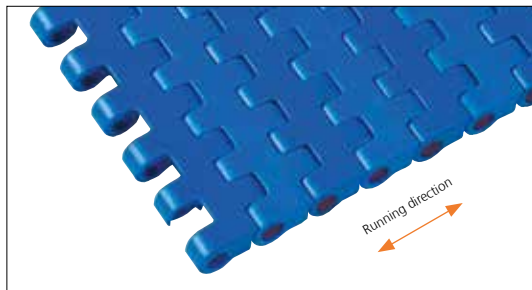

Straight running belt  
 Nominal pitch: 12.7 mm (0.50 in)  
 Surface type: Flat  
 Surface opening: Closed  
 Backflex radius: 20.0 mm (0.80 in)  
 Pin diameter: 5.0 mm (0.20 in)

Belt material & color	POM-SLF <b>B</b>	PP <b>W</b> <b>G</b>	PP <b>B</b>	PE <b>B</b>	POM-EC <b>K</b>	mm		in	
						P (Nominal)	T	mm	in
Pin material & color	PP <b>B</b>	PP <b>W</b>	PP <b>B</b>	PE <b>N</b>	PP <b>B</b>	L	-	-	-

Non standard material and color: See uni Material and Color Overview.

Alternative pin and lock materials: Solid Lockpin: PA6.6 **D** Lockpin: PBT **LG** PA6.6 **N** **D** PP **B** PE **N**

Belt width		Permissible tensile force (Belt/pin material)						Belt weight (Belt/pin material)						*Min. No. drive sprocket per shaft	Number of wear strips (Min. No.)	
		POM-SLF/PP POM-EC/PP		PP/PP		PE/PE		POM-SLF/PP POM-EC/PP		PP/PP		PE/PE			**Carry (pcs)	**Return (pcs)
mm	in	N	lbf	N	lbf	N	lbf	kg/m	lb/ft	kg/m	lb/ft	kg/m	lb/ft			
25	1.0	475	107	325	73	200	45	0.2	0.14	0.2	0.10	0.1	0.10	1	1	1
39	1.5	741	167	507	114	312	70	0.3	0.21	0.2	0.16	0.2	0.15	1	1	1
45	1.8	855	192	585	132	360	81	0.4	0.25	0.3	0.18	0.3	0.18	2	1	1
77	3.0	1463	329	1001	225	616	138	0.6	0.42	0.5	0.32	0.5	0.31	2	2	2
153	6.0	2907	653	1989	447	1224	275	1.3	0.84	0.9	0.63	0.9	0.61	2	2	2
229	9.0	4351	978	2977	669	1832	412	1.9	1.26	1.4	0.94	1.4	0.91	3	2	2
305	12.0	5795	1303	3965	891	2440	549	2.5	1.68	1.9	1.25	1.8	1.21	4	3	2
382	15.0	7258	1632	4966	1116	3056	687	3.1	2.11	2.3	1.57	2.3	1.51	4	3	2
458	18.0	8702	1956	5954	1338	3664	824	3.8	2.52	2.8	1.88	2.7	1.82	5	4	2
534	21.0	10146	2281	6942	1561	4272	960	4.4	2.94	3.3	2.19	3.2	2.12	6	4	2
610	24.0	11590	2605	7930	1783	4880	1097	5.0	3.36	3.7	2.50	3.6	2.42	7	5	3
687	27.0	13053	2934	8931	2008	5496	1236	5.6	3.79	4.2	2.82	4.1	2.72	7	5	3
763	30.0	14497	3259	9919	2230	6104	1372	6.3	4.20	4.7	3.13	4.5	3.03	8	6	3

Additional standard belt widths are available in steps of 76.3 mm (3.00 in). Additional non-standard belt widths are available in steps of 38.1 mm (1.50 in).

1983	78.1	37677	8470	25779	5795	15864	3566	16.3	10.93	12.1	8.13	11.7	7.86	20	14	7
------	------	-------	------	-------	------	-------	------	------	-------	------	------	------	------	----	----	---

Additional standard belt widths are available in steps of 76.3 mm (3.00 in). Additional non-standard belt widths are available in steps of 38.1 mm (1.50 in).

2974	117.1	56506	12703	38662	8691	23792	5348	24.4	16.39	18.1	12.19	17.5	11.79	30	20	10
------	-------	-------	-------	-------	------	-------	------	------	-------	------	-------	------	-------	----	----	----

General belt tolerance is +0/-0.4% at 23°C/73°F and 50% RH. For exact belt width contact Customer Service. Non standard belt width on request.

The belt width in PE is 0.3 % wider than the belt width in the table.

\*Max. Load per Drive Sprocket. Belt material: POM-SLF 1000 N (225 lbf), PP 800 N (180 lbf), PE 800 N (180 lbf), POM-EC 1000 N (225 lbf).

\*\*Max. Spacing between wear strips, Carry: 152.0 mm (6.00 in); Return: 304.0 mm (12.00 in).

= Single Link



STANDARD

STRAIGHT RUNNING

PITCH 12.7 MM/0.50 IN

## Accessories

### Rubber Top

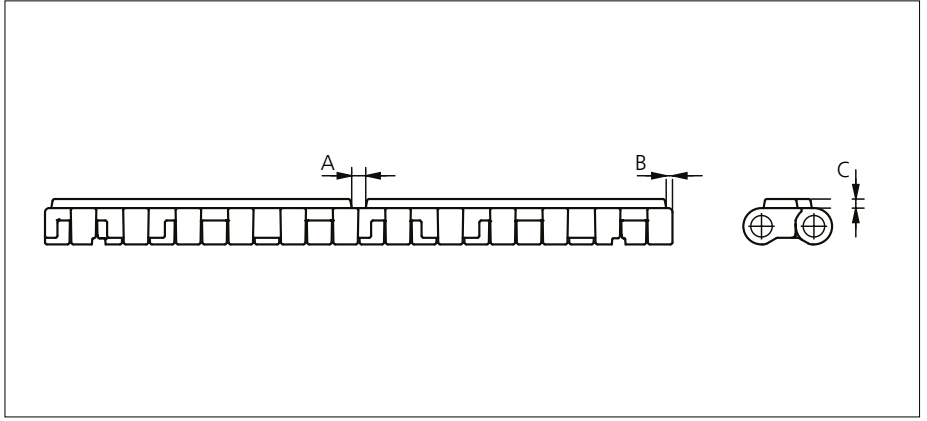

Type	Belt material & color	Rubber material & color	A		B		C		Link size	Width	
			mm	in	mm	in	mm	in		mm	in
Flat	PP <b>W</b>	03 <b>N</b>	3.4	0.13	1.5	0.06	2.2	0.09	K300	75.8	2.98
	PP <b>G</b>	03 <b>K</b>							K600	152.0	5.98

Non Standard material and color: See uni Material and Color Overview.

Rubber Top is not available in belt width below 77.0 mm (3.00 in).

## Accessories

### Non Standard uni AmFlight

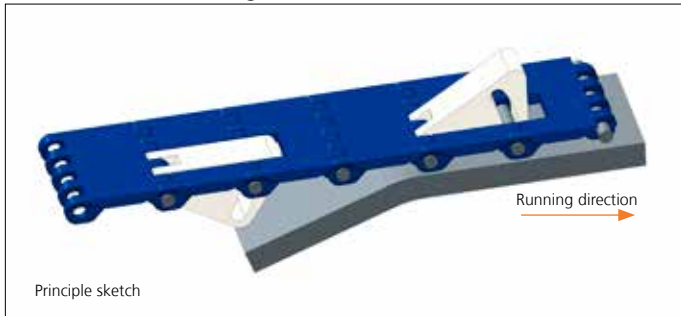

Other Non Standard option: See uni AmFlight Overview.

### Sprocket

No. of teeth	Bore size									Overall diameter		Pitch-diameter		Hub-diameter		Dimension A		Dimension B		Single row/Two way	Molded	PAG	LG
	Pilot bore		18.0	25.4	30.0	31.8	38.1	40.0	60.0														
	mm	in																					
Z10	✓	●								41.3	1.63	41.1	1.62	28.0	1.10	15.2	0.60	25	0.98	✓	✓		
Z19	✓		●	●	●	■	●			78.3	3.06	77.2	3.04	65.0	2.56	33.7	1.33	43	1.69	✓	✓		
Z28	✓		●	●	●	■	●			114.9	4.52	113.4	4.46	65.0	2.56	52	2.05	61.1	2.41	✓	✓		
Z28								■		114.9	4.52	113.4	4.46	100.0	3.93	52	2.05	61.1	2.41	✓	✓		
Z38	✓				●	●	■	●		155.5	6.12	153.8	6.06	75.0	2.95	72.2	2.84	81.3	3.20	✓	✓		

■ Molded sprocket

● Molded sprocket



Other sprocket sizes are available upon request.  
 Other bore sizes on sprockets are available upon request.  
 Round bores are always delivered with keyway.  
 Max. load per sprocket shown does not take bore size into account.  
 Please also ensure that sufficient size shaft is chosen for corresponding load.  
 Width of tooth = Single row: 7.0 mm (0.28 in)  
 Width of One-part sprocket = Single row: 20.0 mm (0.79 in)

### uni UltraClean Two-Part Sprocket

No. of teeth	Bore size			Overall diameter		Pitch-diameter		Hub-diameter		Dimension A		Dimension B		Single row/Two way	Moulded	PAG	W
	in	1.50	1.57														
	mm	38.1	40.0														
Z28		■	■	114.9	4.52	113.4	4.46	80.0	3.15	52.0	2.05	61.1	2.41	✓	✓		
Z38			■	155.5	6.12	153.8	6.06	126.0	4.96	72.2	2.84	81.3	3.20	✓	✓		

■ Moulded uni UltraClean TwoPart Sprocket

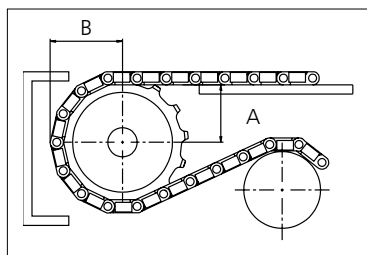

Nosebars Min. Dimensions

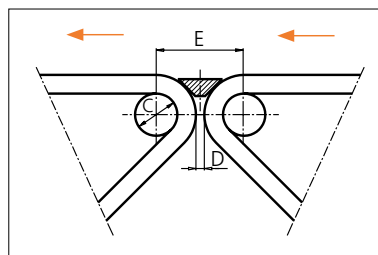

	mm	in
C	20.0	0.79
D	4.0	0.16
E	41.6	1.64

Width of UltraClean Two-part sprocket = Single row: 44.0 mm (1.73 in)  
 Width of UltraClean Two-part sprocket, tooth = Single row: 7.0 mm (0.28 in)

uni Retainer Rings: See uni Retainer Ring data sheet.  
 For correct sprocket position: See uni Assembly Instructions for uni M-QNB.  
 For more detailed sprocket information, contact Customer Service.



Conveyor Belts



Seamless Belts



Modular Belts



Timing Belts



Transmission Belts



Fabrication & service

Expert advice, quality solutions and local service for all your belting needs  
[www.ammeraalbeltech.com](http://www.ammeraalbeltech.com)

**Ammeraal Beltech Modular A/S**  
Hjulgagervej 21  
DK-7100 Vejle

T +45 7572 3100  
F +45 7572 3348  
admin@unichains.com  
www.unichains.com

This information is subject to alteration due to continuous development. Ammeraal Beltech will not be held liable for the incorrect use of the above stated information. This information replaces previous information. All activities performed and services rendered by Ammeraal Beltech are subject to general terms and conditions of sale and delivery, as applied by its operating companies.



# Plastic Modular Belt

Series **uni MPB** Type **Closed**

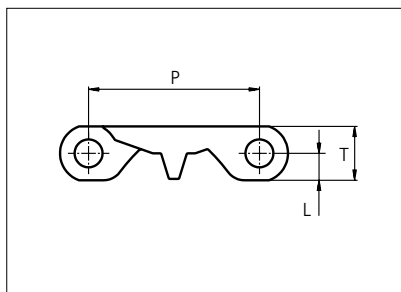
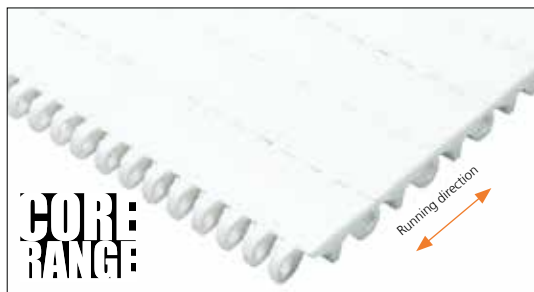

Straight running belt  
 Nominal pitch: 50.8 mm (2.00 in)  
 Surface type: Flat  
 Surface opening: Closed  
 Backflex radius: 65.0 mm (2.6 in)  
 Pin diameter: 8.0 mm (0.31 in)

Belt material & color	POM-DI <input type="checkbox"/> W <input type="checkbox"/> B	PP <input type="checkbox"/> W <input type="checkbox"/> B	PE-I <input type="checkbox"/> N		mm	in		mm	in	
	Pin material & color			<input type="checkbox"/> PP <input type="checkbox"/> W	<input type="checkbox"/> PE <input type="checkbox"/> W	P (Nominal)	50.8	2.00	T	16.0
					L	8.0	0.31	-	-	-

Belt width		Permissible tensile force (Belt/pin material)						Belt weight (Belt/pin material)						*Min. No. drive sprocket per shaft	Number of wear strips (Min. No.)	
		POM-DI/PP		PP/PP		PE-I/PE		POM-DI/PP		PP/PP		PE-I/PE			**Carry (pcs)	**Return (pcs)
mm	in	N	lbf	N	lbf	N	lbf	Kg/m	lb/ft	Kg/m	lb/ft	Kg/m	lb/ft			
152	6.0	4180	940	2432	547	1976	444	1.8	1.22	1.3	0.85	1.3	0.90	2	2	2
252	9.9	6930	1558	4032	906	3276	736	3.0	2.02	2.1	1.41	2.2	1.49	2	2	2
303	11.9	8333	1873	4848	1090	3939	885	3.6	2.42	2.5	1.69	2.7	1.79	3	3	2
353	13.9	9708	2182	5648	1270	4589	1032	4.2	2.82	2.9	1.97	3.1	2.09	3	3	2
403	15.9	11083	2491	6448	1450	5239	1178	4.8	3.22	3.3	2.25	3.5	2.38	3	3	2
454	17.9	12485	2807	7264	1633	5902	1327	5.4	3.63	3.8	2.53	4.0	2.68	4	4	2
504	19.8	13860	3116	8064	1813	6552	1473	6.0	4.03	4.2	2.81	4.4	2.98	4	4	2
554	21.8	15235	3425	8864	1993	7202	1619	6.6	4.43	4.6	3.09	4.9	3.28	4	4	2
605	23.8	16638	3740	9680	2176	7865	1768	7.2	4.84	5.0	3.37	5.3	3.58	5	5	3
655	25.8	18013	4049	10480	2356	8515	1914	7.8	5.24	5.4	3.65	5.8	3.87	5	5	3
706	27.8	19415	4364	11296	2539	9178	2063	8.4	5.65	5.9	3.94	6.2	4.18	5	5	3
756	29.8	20790	4674	12096	2719	9828	2209	9.0	6.05	6.3	4.22	6.7	4.47	6	6	3
806	31.7	22165	4983	12896	2899	10478	2355	9.6	6.45	6.7	4.50	7.1	4.77	6	6	3
857	33.7	23568	5298	13712	3082	11141	2504	10.2	6.85	7.1	4.78	7.5	5.07	6	6	3
907	35.7	24943	5607	14512	3262	11791	2651	10.8	7.25	7.5	5.06	8.0	5.36	7	7	4
957	37.7	26318	5916	15312	3442	12441	2797	11.4	7.65	7.9	5.34	8.4	5.66	7	7	4
1008	39.7	27720	6231	16128	3626	13104	2946	12.0	8.06	8.4	5.62	8.9	5.96	7	7	4
1058	41.7	29095	6541	16928	3805	13754	3092	12.6	8.46	8.8	5.90	9.3	6.26	8	8	4
1108	43.6	30470	6850	17728	3985	14404	3238	13.2	8.86	9.2	6.18	9.8	6.55	8	8	4
1159	45.6	31873	7165	18544	4169	15067	3387	13.8	9.27	9.6	6.46	10.2	6.85	8	8	4
1209	47.6	33248	7474	19344	4349	15717	3533	14.4	9.67	10.0	6.74	10.6	7.15	9	9	5

General belt tolerance is +0/-0.4% at 23°C/73°F. For exact belt width contact Customer Service.

\*Max. Load per Drive Sprocket. Belt material: POM-DI with snub roller 2000 N (450 lbf) without snub roller 1250 N (281 lbf).

\*\*Max. Spacing between wear strips, Carry: 152 mm (6 in); Return: 304 mm (12 in).



This Core Range datasheet represents our most valued products. For more options see our uni SNB M2 standard range datasheets.

CORE RANGE

STRAIGHT RUNNING

PITCH 50.8 MM/2.00 IN

## Accessories

### Flight

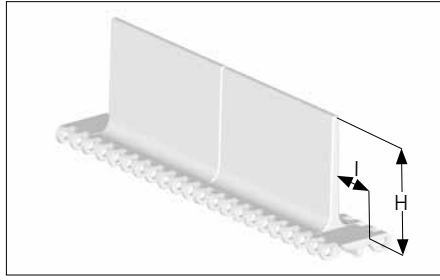

Type	Material & color	H		I*		Link size	Width	
		mm	in	mm	in		mm	in
Flat	PP-I <span style="border: 1px solid black; padding: 0 2px;">W</span>	50.8	2.00	34.0	1.34	K600	151.0	5.94
		101.6	4.00					
		152.4	6.00					

\*Flight rows have separate 34 mm wide edge links on both belt edges forming indents.

All rows with flights are locked with Y-lock: PP-I W

### Sprocket

No of teeth	Bore size				Overall diameter		Pitch diameter		Hub diameter		Dimension A		Dimension B		Single row/One way	Molded	PA6 LG
	Pilot bore	in	1.57	2.36													
	mm	40.0	60.0	mm	in	mm	in	mm	in	mm	in	mm	in				
Z08	✓	■			132.9	5.23	132.8	5.23	70.0	2.75	53.3	2.10	74.9	2.94	✓	✓	
Z10	<sup>1</sup> ✓	■	<sup>1</sup> ■	<sup>2</sup> ■	166.3	6.55	164.4	6.47	<sup>1</sup> 70.0 <sup>2</sup> 120.0	<sup>1</sup> 2.75 <sup>2</sup> 4.72	70.2	2.76	90.7	3.57	✓	✓	
Z12	<sup>1</sup> ✓	■	<sup>1</sup> ■	<sup>2</sup> ■	198.6	7.82	196.3	7.73	<sup>1</sup> 70.0 <sup>2</sup> 120.0	<sup>1</sup> 2.75 <sup>2</sup> 4.72	86.8	3.42	106.6	4.19	✓	✓	

#### Molded sprocket



Width of sprocket = Single row: 42.3 mm (1.66 in)

Width of tooth = Single row: 9.5 mm (0.37 in)

Max. load per sprocket shown does not take bore size into account.

This Core Range datasheet represents our most valued sprockets. For more sprocket options see our uni MPB standard range datasheets.

### uni UltraClean Two-Part Sprocket

No. of teeth	Bore size				Overall diameter		Pitch-diameter		Hub-diameter		Dimension A		Dimension B		Single row/One way	Molded	PA6 <span style="border: 1px solid black; padding: 0 2px;">W</span>
	in	1.50	1.57	2.36													
	mm	38.1	40.0	60.0	mm	in	mm	in	mm	in	mm	in	mm	in			
Z8		■	■		132.9	5.23	132.8	5.23	80.0	3.15	53.3	2.10	74.9	2.94	✓	✓	
Z10		<sup>1</sup> ■	<sup>1</sup> ■	<sup>2</sup> ■	166.3	6.55	164.4	6.47	<sup>1</sup> 126.0 <sup>2</sup> 118.0	<sup>1</sup> 4.96 <sup>2</sup> 4.65	70.2	2.76	90.7	3.57	✓	✓	
Z12		<sup>1</sup> ■	<sup>1</sup> ■	<sup>2</sup> ■	198.6	7.82	196.3	7.73	<sup>1</sup> 126.0 <sup>2</sup> 118.0	<sup>1</sup> 4.96 <sup>2</sup> 4.65	86.8	3.42	106.6	4.19	✓	✓	

#### Moulded uni UltraClean TwoPart Sprocket

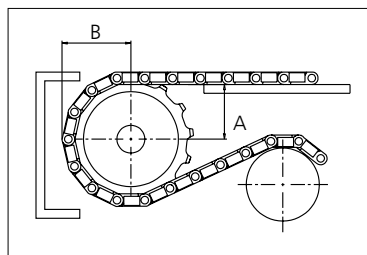

Width of UltraClean Two-part sprocket = Single row: 44.0 mm (1.73 in)

Width of UltraClean Two-part sprocket, tooth = Single row: 9.5 mm (0.37 in)

uni Retainer Rings: See uni Retainer Ring data sheet.

For correct sprocket position: See uni Assembly Instructions for uni MPB.

For more detailed sprocket information. contact Customer Service.



Expert advice, quality solutions and local service for all your belting needs  
[www.ammeraalbeltech.com](http://www.ammeraalbeltech.com)

**Ammeraal Beltech Modular A/S**  
Hjulmagervej 21  
DK-7100 Vejle

T +45 7572 3100  
F +45 7572 3348  
admin@unichains.com  
www.unichains.com

This information is subject to alteration due to continuous development. Ammeraal Beltech will not be held liable for the incorrect use of the above stated information. This information replaces previous information. All activities performed and services rendered by Ammeraal Beltech are subject to general terms and conditions of sale and delivery, as applied by its operating companies.





# Plastic Modular Belt

Series **uni MPB** Type **22% Open**

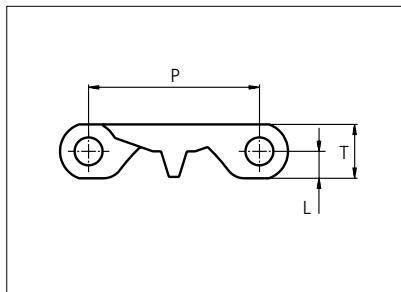

Straight running belt  
 Nominal pitch: 50.8 mm (2.00 in)  
 Surface type: Flat  
 Surface opening: 22%  
 Backflex radius: 65.0 mm (2.6 in)  
 Pin diameter: 8.0 mm (0.31 in)

Belt material & color	PP W		mm	in		mm	in
	Pin material & color	PP W	P (Nominal)	50.8	2.00	T	16.0
L			8.0	0.31	-	-	-

Belt width		Permissible tensile force (Belt/pin material)		Belt weight (Belt/pin material)		*Min. No. drive sprocket per shaft	Number of wear strips (Min. No.)	
		PP/PP		PP/PP			**Carry (pcs)	**Return (pcs)
mm	in	N	lbf	kg/m	lb/ft			
151	5.9	2416	543	1.1	0.73	2	2	2
252	9.9	4032	906	1.8	1.22	2	2	2
302	11.9	4832	1086	2.2	1.46	3	3	2
353	13.9	5648	1270	2.5	1.71	3	3	2
403	15.9	6448	1450	2.9	1.95	3	3	2
453	17.8	7248	1629	3.3	2.19	4	4	2
504	19.8	8064	1813	3.6	2.44	4	4	2
554	21.8	8864	1993	4.0	2.68	4	4	2
604	23.8	9664	2172	4.3	2.92	5	5	3
655	25.8	10480	2356	4.7	3.17	5	5	3
705	27.8	11280	2536	5.1	3.41	5	5	3
755	29.7	12080	2716	5.4	3.65	6	6	3
806	31.7	12896	2899	5.8	3.90	6	6	3
856	33.7	13696	3079	6.2	4.14	6	6	3
906	35.7	14496	3259	6.5	4.38	7	7	4
957	37.7	15312	3442	6.9	4.63	7	7	4
1007	39.6	16112	3622	7.3	4.87	7	7	4
1057	41.6	16912	3802	7.6	5.11	8	8	4
1108	43.6	17728	3985	8.0	5.36	8	8	4
1158	45.6	18528	4165	8.3	5.60	8	8	4
1208	47.6	19328	4345	8.7	5.85	9	9	5

General belt tolerance is +0/-0.4% at 23°C/73°F and 50% RH. For exact belt width contact Customer Service.

\*Max. Load per Drive Sprocket. Belt material: PP with snub roller 2000 N (450 lbf) without snub roller 1250 N (281 lbf)

\*\*Max. Spacing between wear strips, Carry: 152.0 mm (6.00 in) ; Return: 304.0 mm (12.00 in).



This Core Range datasheet represents our most valued products. For more options see our uni MPB standard range datasheets.

CORE RANGE

STRAIGHT RUNNING

PITCH 50.8 MM/2.00 IN

## Sprocket

No of teeth	Bore size				Overall diameter		Pitch diameter		Hub diameter		Dimension A		Dimension B		Single row/One way	Molded	PA6 LG
	Pilot bore	in	1.57	2.36													
		mm	40.0	60.0	mm	in	mm	in	mm	in	mm	in					
Z08	✓		■		132.9	5.23	132.8	5.23	70.0	2.75	53.3	2.10	74.9	2.94	✓	✓	
Z10	<sup>1</sup> ✓		<sup>1</sup> ■	<sup>2</sup> ■	166.3	6.55	164.4	6.47	<sup>1</sup> 70.0 <sup>2</sup> 120.0	<sup>1</sup> 2.75 <sup>2</sup> 4.72	70.2	2.76	90.7	3.57	✓	✓	
Z12	<sup>1</sup> ✓		<sup>1</sup> ■	<sup>2</sup> ■	198.6	7.82	196.3	7.73	<sup>1</sup> 70.0 <sup>2</sup> 120.0	<sup>1</sup> 2.75 <sup>2</sup> 4.72	86.8	3.42	106.6	4.19	✓	✓	

### Molded sprocket



Width of sprocket = Single row: 42.3 mm (1.66 in)  
 Width of tooth = Single row: 9.5 mm (0.37 in)

Max. load per sprocket shown does not take bore size into account.

## uni UltraClean Two-Part Sprocket

No. of teeth	Bore size				Overall diameter		Pitch-diameter		Hub-diameter		Dimension A		Dimension B		Single row/One way	Moulded	PA6 W
	in	1.50	1.57	2.36													
	mm	38.1	40.0	60.0	mm	in	mm	in	mm	in	mm	in					
Z8		■	■		132.9	5.23	132.8	5.23	80.0	3.15	53.3	2.10	74.9	2.94	✓	✓	
Z10		<sup>1</sup> ■	<sup>1</sup> ■	<sup>2</sup> ■	166.3	6.55	164.4	6.47	<sup>1</sup> 126.0 <sup>2</sup> 118.0	<sup>1</sup> 4.96 <sup>2</sup> 4.65	70.2	2.76	90.7	3.57	✓	✓	
Z12		<sup>1</sup> ■	<sup>1</sup> ■	<sup>2</sup> ■	198.6	7.82	196.3	7.73	<sup>1</sup> 126.0 <sup>2</sup> 118.0	<sup>1</sup> 4.96 <sup>2</sup> 4.65	86.8	3.42	106.6	4.19	✓	✓	

### Moulded uni UltraClean TwoPart Sprocket

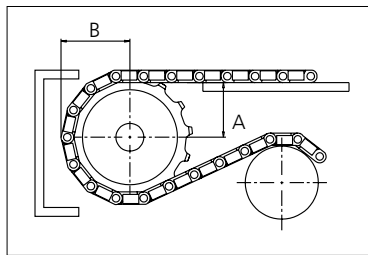

Width of UltraClean Two-part sprocket = Single row: 44.0 mm (1.73 in)  
 Width of UltraClean Two-part sprocket, tooth = Single row: 9.5 mm (0.37 in)

uni Retainer Rings: See uni Retainer Ring data sheet.  
 For correct sprocket position: See uni Assembly Instructions for uni MPB.  
 For more detailed sprocket information, contact Customer Service.

This Core Range datasheet represents our most valued sprockets.  
 For more sprocket options see our uni MPB standard range datasheets.

uni MPB 22% Open/2019.03.04



Expert advice, quality solutions and local service for all your belting needs  
[www.ammeraalbeltech.com](http://www.ammeraalbeltech.com)

**Ammeraal Beltech Modular A/S**  
 Hjulmagervej 21  
 DK-7100 Vejle

T +45 7572 3100  
 F +45 7572 3348  
 admin@unichains.com  
 www.unichains.com

This information is subject to alteration due to continuous development. Ammeraal Beltech will not be held liable for the incorrect use of the above stated information. This information replaces previous information. All activities performed and services rendered by Ammeraal Beltech are subject to general terms and conditions of sale and delivery, as applied by its operating companies.



# Plastic Modular Belt

Series **uni MPB** Type **C**

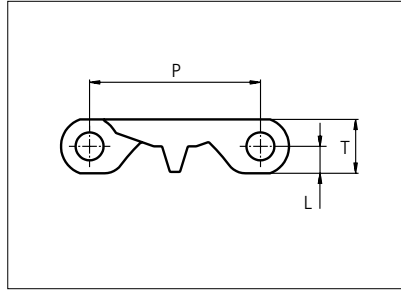

Straight running belt  
 Nominal pitch: 50.8 mm (2.00 in)  
 Surface type: Flat  
 Surface opening: Closed  
 Backflex radius: 65.0 mm (2.6 in)  
 Pin diameter: 8 mm (0.31 in)

STANDARD

Belt material & color	POM-DI <span>W</span> <span>B</span>	PP <span>W</span> <span>B</span>	NBWR <span>W</span>	PE-I <span>N</span> <span>B</span>		mm	in		mm	in	
	Pin material & color				PP <span>W</span>	PE <span>W</span>	<b>P (Nominal)</b>	50.8	2.00	<b>T</b>	16.0
						<b>L</b>	8.0	0.31	-	-	-

Non standard material and color: See uni Material and Color Overview.

Alternative pin and lock materials: Pin: PA6.6 N W PE W PBT LG SS304 Lockpin: PA6.6 B PBT LG Trilock: PA6.6 N

Belt width		Permissible tensile force (Belt/pin material)								Belt weight (Belt/pin material)								*Min. No. drive sprocket per shaft	Number of wear strips (Min. No.)	
		POM-DI/PP		PP/PP		PE-I/PE		NBWR/PP		POM-DI/PP		PP/PP		PE-I/PE		NBWR/PP			**Carry (pcs)	**Return (pcs)
mm	in	N	lbf	N	lbf	N	lbf	N	lbf	Kg/m	lb/ft	Kg/m	lb/ft	Kg/m	lb/ft	Kg/m	lb/ft			
68	2.7	1870	420	1088	245	884	199	561	126	0.8	0.54	0.6	0.38	0.6	0.40	0.7	0.44	2	2	2
84	3.3	2306	518	1341	302	1090	245	692	155	1.0	0.67	0.7	0.47	0.7	0.50	0.8	0.54	2	2	2
151	5.9	4153	933	2416	543	1963	441	1246	280	1.8	1.21	1.3	0.84	1.3	0.89	1.4	0.97	2	2	2
168	6.6	4620	1039	2688	604	2184	491	1386	312	2.0	1.34	1.4	0.94	1.5	0.99	1.6	1.08	2	2	2
185	7.3	5088	1144	2960	665	2405	541	1526	343	2.2	1.48	1.5	1.03	1.6	1.09	1.8	1.19	2	2	2
202	8.0	5555	1249	3232	727	2626	590	1667	375	2.4	1.62	1.7	1.13	1.8	1.19	1.9	1.30	2	2	2
219	8.6	6023	1354	3504	788	2847	640	1807	406	2.6	1.75	1.8	1.22	1.9	1.30	2.1	1.41	2	2	2
235	9.3	6463	1453	3760	845	3055	687	1939	436	2.8	1.88	2.0	1.31	2.1	1.39	2.3	1.52	2	2	2

Additional standard belt widths are available in steps of 16.8 mm (0.66 in).

655	25.8	18013	4049	10480	2356	8515	1914	5404	1215	7.8	5.24	5.4	3.65	5.8	3.87	6.3	4.23	5	5	3
672	26.5	18480	4154	10752	2417	8736	1964	5544	1246	8.0	5.37	5.6	3.75	5.9	3.97	6.5	4.34	5	5	3
688	27.1	18920	4253	11008	2475	8944	2011	5676	1276	8.2	5.50	5.7	3.84	6.1	4.07	6.6	4.44	5	5	3
705	27.8	19388	4358	11280	2536	9165	2060	5816	1307	8.4	5.64	5.9	3.93	6.2	4.17	6.8	4.55	5	5	3
722	28.4	19855	4463	11552	2597	9386	2110	5957	1339	8.6	5.77	6.0	4.03	6.4	4.27	6.9	4.66	5	5	3

Additional standard belt widths are available in steps of 16.8 mm (0.66 in).

1963	77.3	53983	12135	31408	7061	25519	5737	16195	3641	23.4	15.70	16.3	10.95	17.3	11.61	18.8	12.66	14	14	7
------	------	-------	-------	-------	------	-------	------	-------	------	------	-------	------	-------	------	-------	------	-------	----	----	---

Additional standard belt widths are available in steps of 16.8 mm (0.66 in).

2970	116.9	81675	18361	47520	10682	38610	8680	24503	5508	35.3	23.75	24.7	16.57	26.1	17.56	28.5	19.16	20	20	10
------	-------	-------	-------	-------	-------	-------	------	-------	------	------	-------	------	-------	------	-------	------	-------	----	----	----

General belt tolerance is +0/-0.4% at 23°C/73°F. For exact belt width contact Customer Service. Non standard belt width on request.

\*Max. Load per Drive Sprocket. Belt material: POM-DI with snub roller 2000 N (450 lbf) without snub roller 1250 N (281 lbf).

\*\*Max. Spacing between wear strips. Carry: 152 mm (6 in); Return: 304 mm (12 in).

= Single Link



STRAIGHT RUNNING

PITCH 50.8 MM/2.00 IN

## Accessories

### Rubber Top

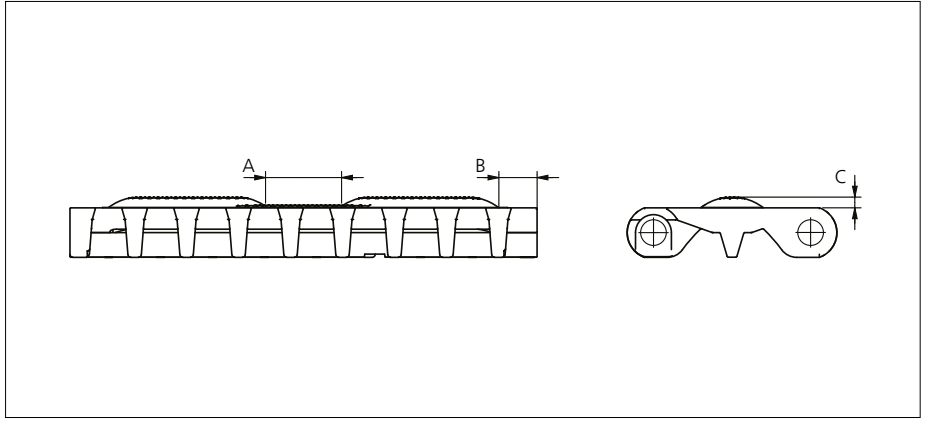

Type	Belt Material & color	Rubber Material & color	A		B		C		Link size	Width	
			mm	in	mm	in	mm	in		mm	in
Curved Rough	POM-DI <b>W</b>	01 <b>N</b>	24.0	0.94	10.0	0.39	3.5	0.14	K600	151.0	5.94

Non Standard material and color: See uni Material and Color Overview.

## Accessories

### Flight

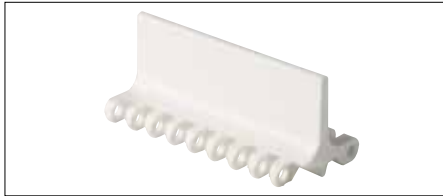

See separate uni MPB series Flight datasheet.

## Accessories

### Side Guard

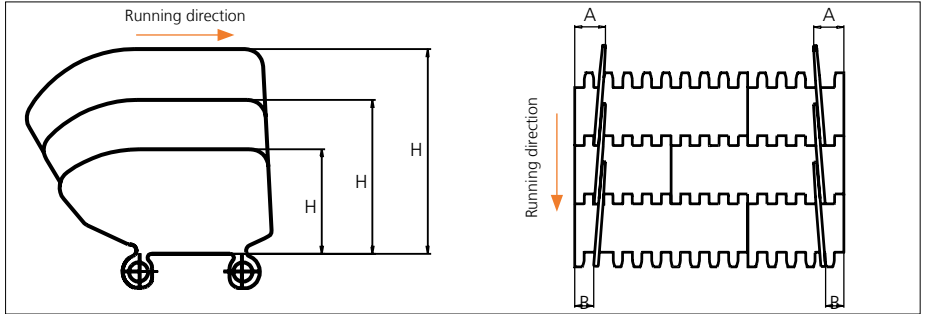

Type	Side Guard Material & color	H		A		B	
		mm	in	mm	in	mm	in
Closed	PE-I <b>B</b> <b>N</b>	50.8	2.00	32.0	1.26	16.0	0.63
	PP-I <b>W</b> <b>B</b>	76.2	3.00				
		101.6	4.00				

\*34.0 mm (1.34 in) combined with flight. Increment: 8.4 mm (0.33 in).

Note: Backflex radius when Side Guards are used: 200.0 mm (7.90 in).

## Accessories

### Tab

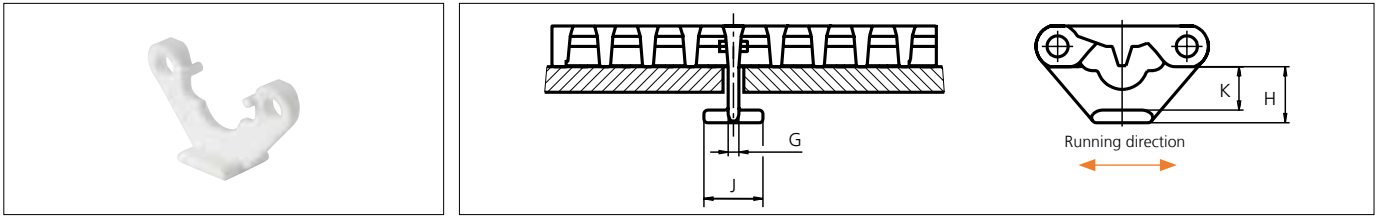

Type	Tab Material & color	G		J		K		H	
		mm	in	mm	in	mm	in	mm	in
Bottom Hold Down	POM-DI <b>W</b>	4.2	0.17	23.2	0.91	17.0	0.67	22.0	0.87

Note: When using tabs, please verify sufficient clearance to the shaft. Max. shaft diameter = Sprocket pitch diameter - 63.5 mm (2.50 in). When using square shafts, please verify that the diagonal does not exceed max. diameter. Example: Sprocket z = 6: Max. shaft diameter 101.6 - 63.5 = ø38.1 mm (4.00 - 2.50 = ø1.4 in).

Note: When using a belt system with tabs, the temperature should be constant. Please note that the tabs are not always placed in the middle of the belt.

Non Standard material and color: See uni Material and Color Overview.

## Accessories

### Tab/NON STANDARD

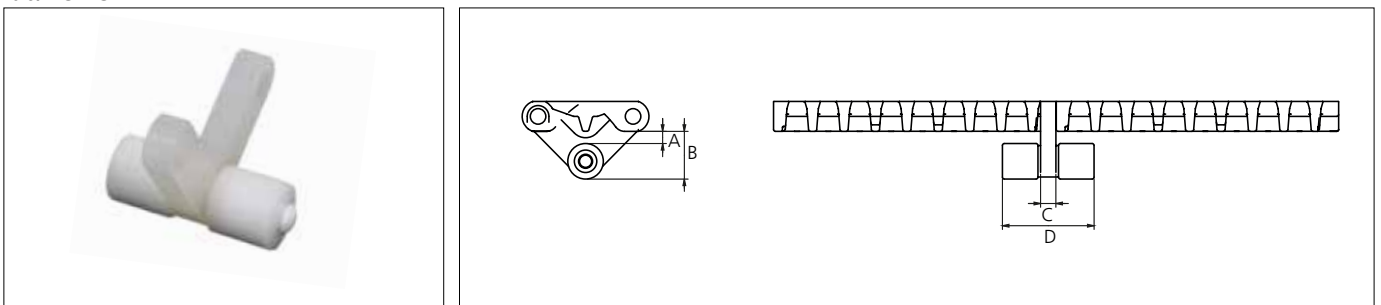

Type	Belt material & color	A		B		C		D	
		mm	in	mm	in	mm	in	mm	in
Bottom Hold Down Roller Tab	PP <b>W</b>	6.5	0.26	25.5	1.00	8.2	0.32	49.0	1.93

Non Standard material and color: See uni Material and Color Overview.

## Accessories

### Non standard uni AmFlight

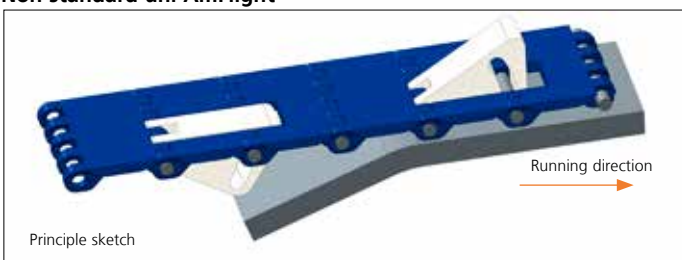

Other non standard option: See uni AmFlight Overview.

## Sprocket

No of teeth	Bore size										Overall diameter		Pitch-diameter		Hub-diameter		Dimension A		Dimension B		Single row/One way	Double row/Two way	Molded	Machined
	Pilot bore																							
	mm	in	1.00	1.18	1.25	1.50	1.57	2.36	2.50	3.54	mm	in	mm	in	mm	in	mm	in	mm	in				
Z06	✓	●	●	●	■	●	■				99.5	3.92	101.6	4.00	65.0	2.56	36.0	1.42	59.3	2.33	✓	✓		
Z08	✓	●	●	●	■	●	■	■			132.9	5.23	132.8	5.23	70.0	2.75	53.3	2.10	74.9	2.94	✓	✓ <sup>1</sup>	✓	
Z10	✓		●	●	●	■	■	■	■	■	166.3	6.55	164.4	6.47	<sup>1</sup> 70.0 <sup>2</sup> 120.0	2.75 4.72	70.2	2.76	90.7	3.57	✓	✓	✓	
Z12	✓		●	●	●	■	■	■	■	■	198.6	7.82	196.3	7.73	<sup>1</sup> 70.0 <sup>2</sup> 120.0 <sup>3</sup> 164.0	2.75 4.72 6.45	86.8 86.8	3.42 3.42	106.6 106.6	4.19 4.19	✓ <sup>1+2</sup>	✓ <sup>2+3</sup>	✓	
Z16	✓		●	●	●	■	■	■	■	■	263.8	10.39	260.4	10.25	<sup>1</sup> 150.0 <sup>2</sup> 164.0 <sup>3</sup> 200.0	5.90 6.45 7.87			138.7	5.46	✓ <sup>1</sup>	✓ <sup>2+3</sup>	✓	✓

● Molded sprocket    ■ Molded sprocket    ■ Machined sprocket



Other sprocket sizes are available upon request.  
 Other bore sizes on sprockets are available upon request.  
 Round bores are always delivered with keyway.  
 Max. load per sprocket shown does not take bore size into account.  
 Please also ensure that sufficient size shaft is chosen for corresponding load.

Width of tooth = Single row: 9.5 mm (0.37 in)  
 = Double row: 17.8 mm (0.70 in)

Width of One-part sprocket = Single row: 42.3 mm (1.66 in)  
 = Double row: 42.3 mm (1.66 in)  
 = <sup>3</sup>Double row: 50.0 mm (1.96 in)

## uni UltraClean Two-Part Sprocket

No. of teeth	Bore size				Overall diameter		Pitch-diameter		Hub-diameter		Dimension A		Dimension B		Single row/One way	Moulded
	in	1.50	1.57	2.36												
	mm	38.1	40.0	60.0	mm	in	mm	in	mm	in	mm	in	mm	in		
Z8		■	■		132.9	5.23	132.8	5.23	80.0	3.15	53.3	2.10	74.9	2.94	✓	✓
Z10		■	■	■	166.3	6.55	164.4	6.47	<sup>1</sup> 126.0 <sup>2</sup> 118.0	<sup>1</sup> 4.96 <sup>2</sup> 4.65	70.2	2.76	90.7	3.57	✓	✓
Z12		■	■	■	198.6	7.82	196.3	7.73	<sup>1</sup> 126.0 <sup>2</sup> 118.0	<sup>1</sup> 4.96 <sup>2</sup> 4.65	86.8	3.42	106.6	4.19	✓	✓

■ Moulded uni UltraClean TwoPart Sprocket

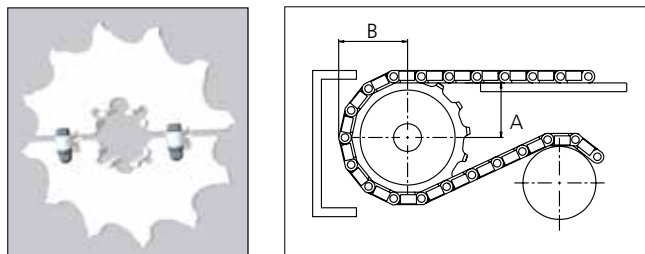

Width of UltraClean Two-part sprocket = Single row: 44.0 mm (1.73 in)  
 Width of UltraClean Two-part sprocket, tooth = Single row: 9.5 mm (0.37 in)

uni Retainer Rings: See uni Retainer Ring data sheet.  
 For correct sprocket position: See uni Assembly Instructions for uni MPB.  
 For more detailed sprocket information. contact Customer Service.



This information is subject to alteration due to continuous development. Ammeraal Beltech will not be held liable for the incorrect use of the above stated information. This information replaces previous information. All activities performed and services rendered by Ammeraal Beltech are subject to general terms and conditions of sale and delivery, as applied by its operating companies.

Expert advice, quality solutions and local service for all your belting needs  
[www.ammeraalbeltech.com](http://www.ammeraalbeltech.com)

**Ammeraal Beltech Modular A/S**  
 Hjulmagervej 21  
 DK-7100 Vejle

T +45 7572 3100  
 F +45 7572 3348  
 admin@unichains.com  
 www.unichains.com



# Plastic Modular Belt

Series **uni MPB** Type **16%**

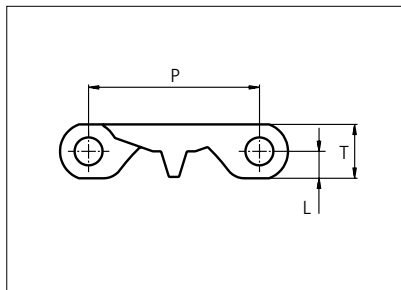

Straight running belt  
 Nominal pitch: 50.8 mm (2.00 in)  
 Surface type: Flat  
 Surface opening: 16%  
 Backflex radius: 65.0 mm (2.60 in)  
 Pin diameter: 8.0 mm (0.31 in)

STANDARD

Belt material & color	PP <b>W</b>	mm	in		mm	in
		P (Nominal)	50.8	2.00	T	16.0
Pin material & color	PP <b>W</b>	L	8.0	0.31	-	-

Non standard material and color: See uni Material and Color Overview.

Alternative pin and lock materials: Pin: PA6.6 **N** PP **W** PE **W** PBT **LG** SS304 Lockpin: PA6.6 **B** PBT **LG** Trilock: PA6.6 **N**

STRAIGHT RUNNING

Belt width		Permissible tensile force (Belt/pin material)				Belt weight (Belt/pin material)				*Min. No. drive sprocket per shaft	Number of wear strips (Min. No.)	
		PP/PP		PE-I/PE		PP/PP		PE-I/PE			**Carry (pcs)	**Return (pcs)
mm	in	N	lbf	N	lbf	Kg/m	lb/ft	Kg/m	lb/ft			
152	6.0	2432	547	1976	444	1.1	0.77	1.2	0.82	2	2	2
202	8.0	3232	727	2626	590	1.5	1.02	1.6	1.09	2	2	2
253	10.0	4048	910	3289	739	1.9	1.28	2.0	1.36	2	2	2
303	11.9	4848	1090	3939	885	2.3	1.53	2.4	1.63	3	3	2
354	13.9	5664	1273	4602	1035	2.7	1.78	2.8	1.90	3	3	2
404	15.9	6464	1453	5252	1181	3.0	2.04	3.2	2.17	3	3	2
455	17.9	7280	1637	5915	1330	3.4	2.29	3.6	2.45	4	4	2
505	19.9	8080	1816	6565	1476	3.8	2.55	4.0	2.72	4	4	2
556	21.9	8896	2000	7228	1625	4.2	2.80	4.4	2.99	4	4	2
606	23.9	9696	2180	7878	1771	4.5	3.05	4.8	3.26	5	5	3
657	25.9	10512	2363	8541	1920	4.9	3.31	5.3	3.53	5	5	3
707	27.8	11312	2543	9191	2066	5.3	3.56	5.7	3.80	5	5	3
758	29.8	12128	2726	9854	2215	5.7	3.82	6.1	4.08	6	6	3

PITCH 50.8 MM/2.00 IN

Additional standard belt widths are available in steps of 50.3 mm (1.98 in) Additional non-standard belt widths are available in steps of 16.8 mm (0.66 in.)

1970	77.6	31520	7086	25610	5757	14.8	9.93	15.8	10.59	14	14	7
------	------	-------	------	-------	------	------	------	------	-------	----	----	---

Additional standard belt widths are available in steps of 50.3 mm (1.98 in) Additional non-standard belt widths are available in steps of 16.8 mm (0.66 in.)

2979	117,3	47664	10715	38727	8706	22,3	15,02	23,8	16,02	20	20	10
------	-------	-------	-------	-------	------	------	-------	------	-------	----	----	----

General belt tolerance is +0/-0.4% at 23°C/73°F and 50% RH. For exact belt width contact Customer Service. Non standard belt width on request.

\*Max. Load per Drive Sprocket. Belt material: PP with snub roller 2000 N (450 lbf) without snub roller 1250 N (281 lbf).

\*\*Max. Spacing between wear strips, Carry: 152.0 mm (6.00 in); Return: 304.0 mm (12.00 in)

= Single Link



## Accessories

### Rubber Top

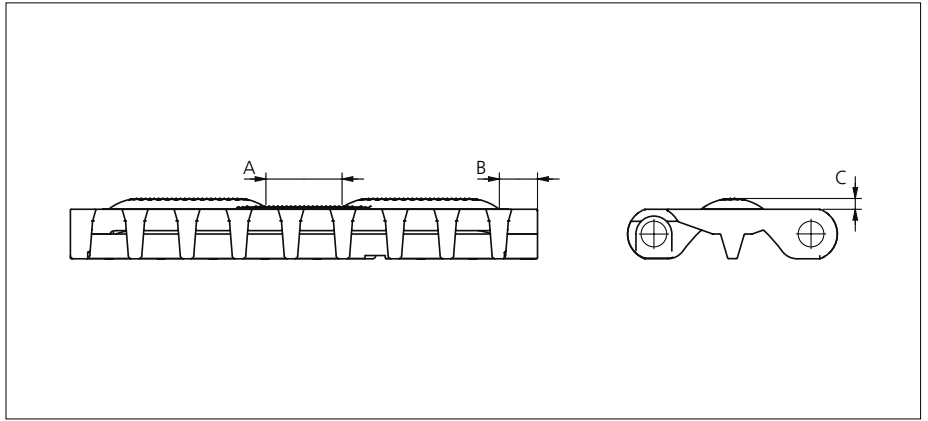

Type	Belt Material & color	Rubber Material & color	A		B		C		Link size	Width	
			mm	in	mm	in	mm	in		mm	in
Curved Rough	POM-DI <b>W</b>	01 <b>N</b>	24.0	0.94	10.0	0.39	3.5	0.14	K600	151.0	5.94

Non Standard material and color: See uni Material and Color Overview.

## Accessories

### Flight



See separate uni MPB series Flight datasheet.

## Accessories

### Side Guard

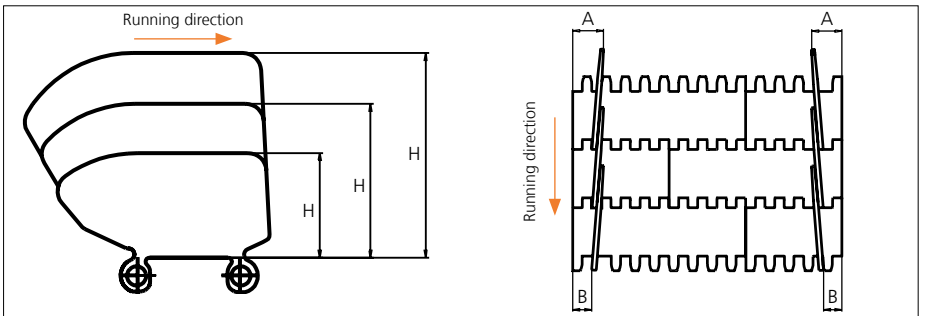

Type	Side Guard Material & color	H		A		B	
		mm	in	mm	in	mm	in
Closed	PE-I <b>B</b> <b>N</b> PP-I <b>W</b> <b>B</b>	50.8	2.00	32.0	1.26	16.0	0.63
		76.2	3.00				
		101.6	4.00				

\*34.0 mm (1.34 in) combined with flight. Increment: 8.4 mm (0.33 in).

Note: Backflex radius when Side Guards are used: 200.0 mm (7.90 in)



## Accessories

### Tab

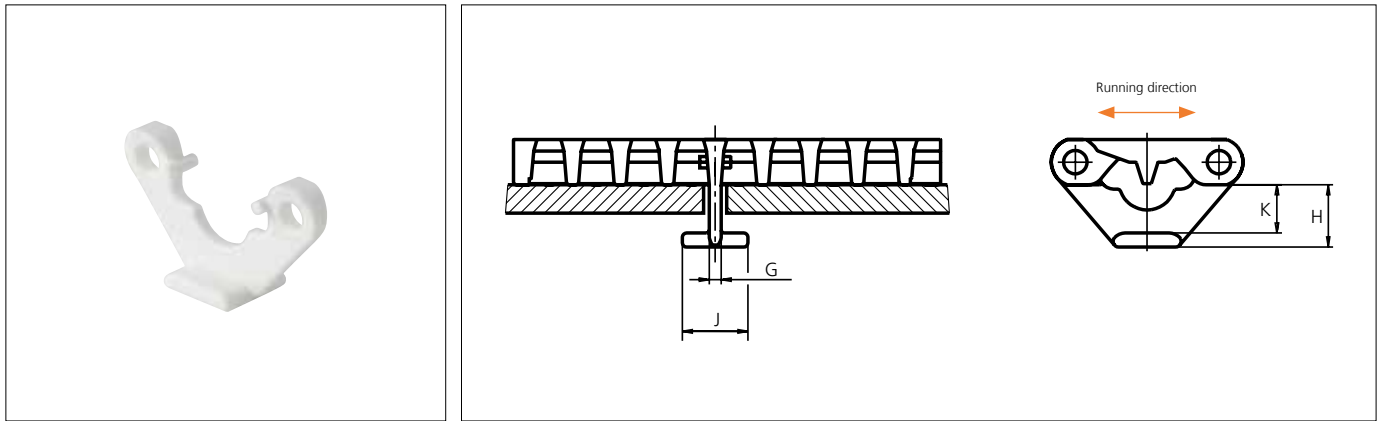

Type	Tab Material & color	G		J		K		H	
		mm	in	mm	in	mm	in	mm	in
Bottom Hold Down	POM-DI <b>w</b>	4.2	0.17	23.2	0.91	17.0	0.67	22.0	0.87

Note: When using tabs, please verify sufficient clearance to the shaft. Max. shaft diameter = Sprocket pitch diameter - 63.5 mm (2.50 in). When using square shafts, please verify that the diagonal does not exceed max. diameter. Example: Sprocket z = 6: Max. shaft diameter 101.6 - 63.5 = ø38.1 mm (4.00 - 2.50 = ø1.4 in).

Note: When using a belt system with tabs, the temperature should be constant. Please note that the tabs are not always placed in the middle of the belt.

Non Standard material and color: See uni Material and Color Overview.

## Accessories

### Non standard uni AmFlight

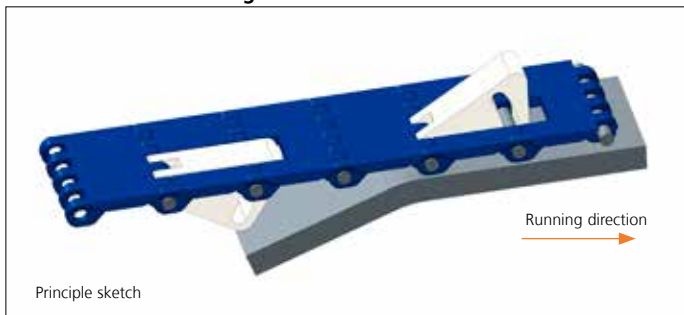

Other non standard option: See uni AmFlight Overview.

## Sprocket

No of teeth	Bore size										Overall diameter		Pitch-diameter		Hub-diameter		Dimension A		Dimension B		Single row/One way	Double row/Two way	Molded	Machined
	Pilot bore		1.00		1.18		1.25		1.50															
	mm	in	25.4	30.0	31.8	38.1	40.0	60.0	63.5	90.0	mm	in	mm	in	mm	in	mm	in						
Z06	✓	●	●	●	■	●	■				99.5	3.92	101.6	4.00	65.0	2.56	36.0	1.42	59.3	2.33	✓		✓	
Z08	✓	●	●	●	■	●	■	■			132.9	5.23	132.8	5.23	70.0	2.75	53.3	2.10	74.9	2.94	✓	1	✓	
Z10	✓		1	1	1	1	1	2	2		166.3	6.55	164.4	6.47	<sup>1</sup> 70.0 <sup>2</sup> 120.0	2.75 4.72	70.2	2.76	90.7	3.57	✓	✓	✓	
Z12	✓		1	1	1	1	1	2	2	3	198.6	7.82	196.3	7.73	<sup>1</sup> 70.0 <sup>2</sup> 120.0 <sup>3</sup> 164.0	2.75 4.72 6.45	86.8 86.8	3.42 3.42	106.6 106.6	4.19 4.19	<sup>1+2</sup> ✓	<sup>2+3</sup> ✓	✓	
Z16	✓		2	2	2	2	2	3	2	3	263.8	10.39	260.4	10.25	<sup>1</sup> 150.0 <sup>2</sup> 164.0 <sup>3</sup> 200.0	5.90 6.45 7.87	119.7	4.71	138.7	5.46	1	<sup>2+3</sup> ✓	✓	✓

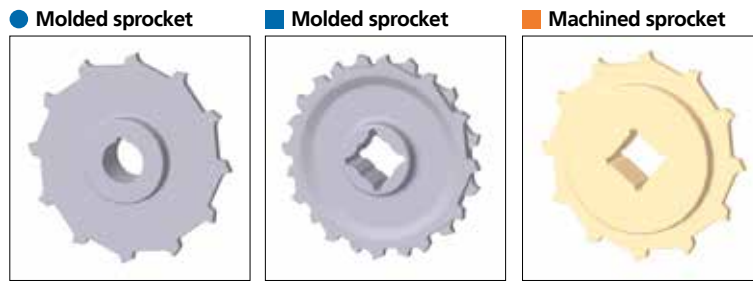

Other sprocket sizes are available upon request.  
 Other bore sizes on sprockets are available upon request.  
 Round bores are always delivered with keyway.  
 Max. load per sprocket shown does not take bore size into account.  
 Please also ensure that sufficient size shaft is chosen for corresponding load.

Width of tooth = Single row: 9.5 mm (0.37 in)  
 = Double row: 17.8 mm (0.70 in)

Width of One-part sprocket = Single row: 42.3 mm (1.66 in)  
 = Double row: 42.3 mm (1.66 in)  
 = <sup>3</sup>Double row: 50.0 mm (1.96 in)

## uni UltraClean Two-Part Sprocket

No. of teeth	Bore size				Overall diameter		Pitch-diameter		Hub-diameter		Dimension A		Dimension B		Single row/One way	Moulded
	in	1.50	1.57	2.36												
	mm	38.1	40.0	60.0	mm	in	mm	in	mm	in	mm	in				
Z8		■	■		132.9	5.23	132.8	5.23	80.0	3.15	53.3	2.10	74.9	2.94	✓	✓
Z10		1	1	2	166.3	6.55	164.4	6.47	126.0 <sup>1</sup> 118.0 <sup>2</sup>	4.96 4.65	70.2	2.76	90.7	3.57	✓	✓
Z12		1	1	2	198.6	7.82	196.3	7.73	126.0 <sup>1</sup> 118.0 <sup>2</sup>	4.96 4.65	86.8	3.42	106.6	4.19	✓	✓

### Moulded uni UltraClean TwoPart Sprocket

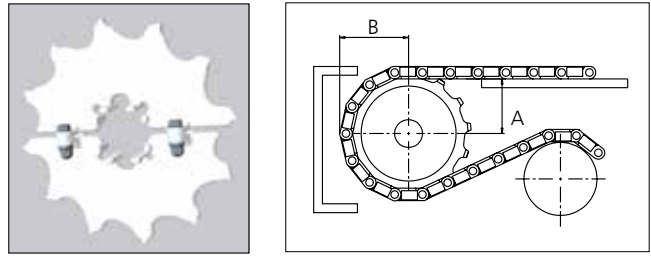

Width of UltraClean two-part sprocket = Single row: 44.0 mm (1.73 in)  
 Width of tooth = Single row: 9.5 mm (0.37 in)

uni Retainer Rings: See uni Retainer Ring data sheet.  
 For correct sprocket position: See uni Assembly Instructions for uni MPB.  
 For more detailed sprocket information. contact Customer Service.

uni MPB 16/2019:03:04

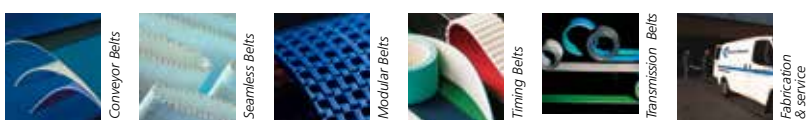

Expert advice, quality solutions and local service for all your belting needs  
[www.ammeraalbeltech.com](http://www.ammeraalbeltech.com)

**Ammeraal Beltech Modular A/S**  
 Hjulmagervej 21  
 DK-7100 Vejle

T +45 7572 3100  
 F +45 7572 3348  
 admin@unichains.com  
 www.unichains.com

This information is subject to alteration due to continuous development. Ammeraal Beltech will not be held liable for the incorrect use of the above stated information. This information replaces previous information. All activities performed and services rendered by Ammeraal Beltech are subject to general terms and conditions of sale and delivery, as applied by its operating companies.



## Accessories

### Rubber Top

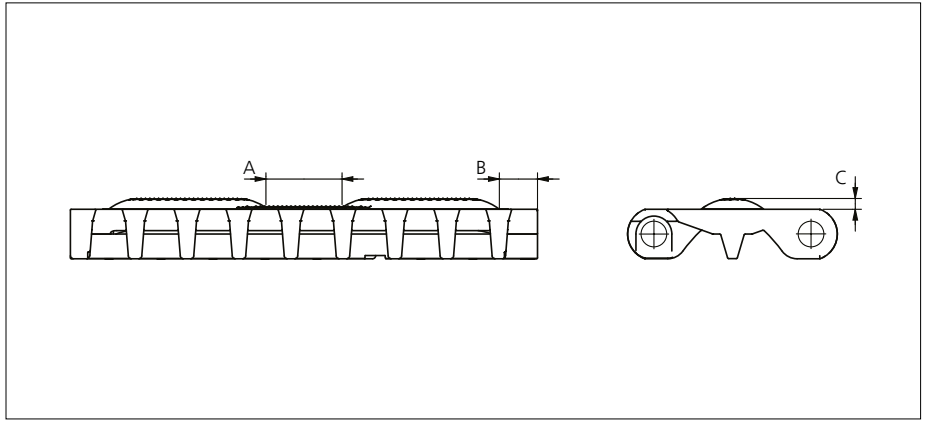

Type	Belt Material & color	Rubber Material & color	A		B		C		Link size	Width	
			mm	in	mm	in	mm	in		mm	in
Curved Rough	POM-DI <b>W</b>	01 <b>N</b>	24.0	0.94	10.0	0.39	3.5	0.14	K600	151.0	5.94

Non Standard material and color: See uni Material and Color Overview.

## Accessories

### Flight



See separate uni MPB series Flight datasheet.

## Accessories

### Side Guard

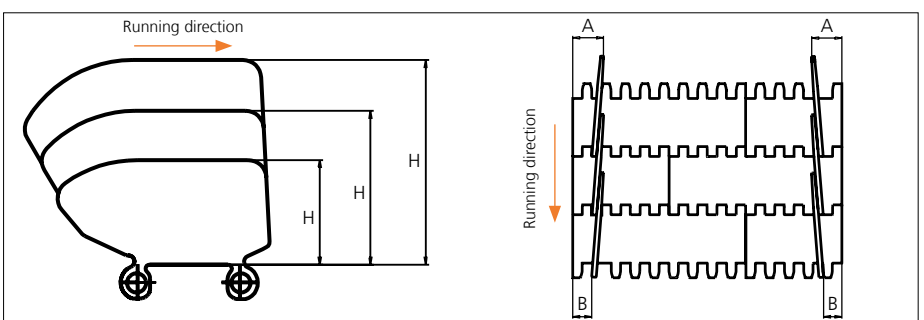

Type	Side Guard Material & color	H		A		B	
		mm	in	mm	in	mm	in
Closed	PE-I <b>B</b> <b>N</b> PP-I <b>W</b> <b>B</b>	50.8	2.00	32.0	1.26	16.0	0.63
		76.2	3.00				
		101.6	4.00				

\*34.0 mm (1.34 in) combined with flight. Increment: 8.4 mm (0.33 in).

Note: Backflex radius when Side Guards are used: 200.0 mm (7.90 in)

## Accessories

### Tab

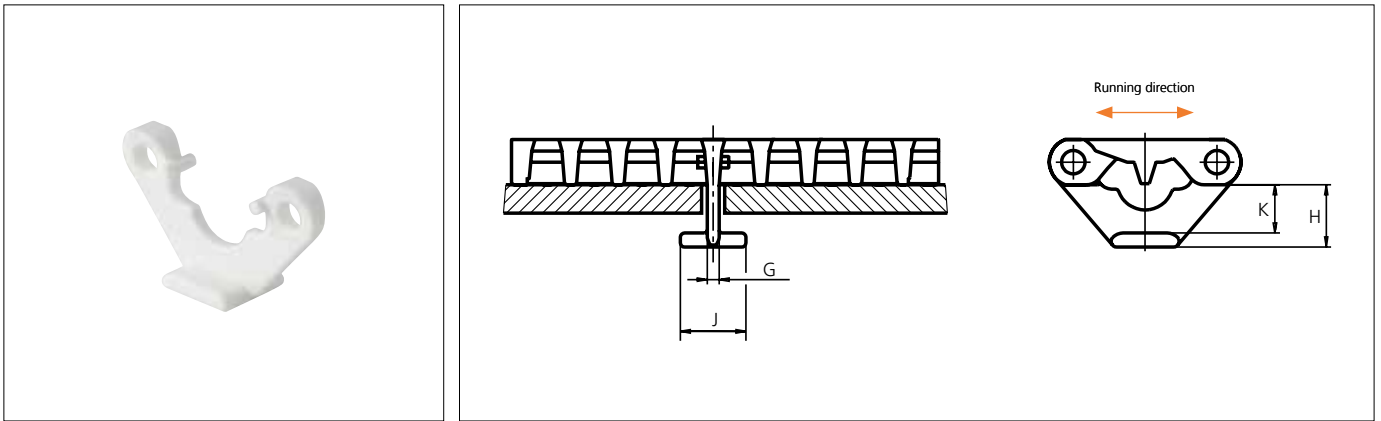

Type	Tab Material & color	G		J		K		H	
		mm	in	mm	in	mm	in	mm	in
Bottom Hold Down	POM-DI <b>w</b>	4.2	0.17	23.2	0.91	17.0	0.67	22.0	0.87

Note: When using tabs, please verify sufficient clearance to the shaft. Max. shaft diameter = Sprocket pitch diameter - 63.5 mm (2.50 in). When using square shafts, please verify that the diagonal does not exceed max. diameter. Example: Sprocket z = 6: Max. shaft diameter 101.6 - 63.5 =  $\varnothing$ 38.1 mm (4.00 - 2.50 =  $\varnothing$ 1.4 in).

Note: When using a belt system with tabs, the temperature should be constant. Please note that the tabs are not always placed in the middle of the belt.

Non Standard material and color: See uni Material and Color Overview.

## Accessories

### Non standard uni AmFlight

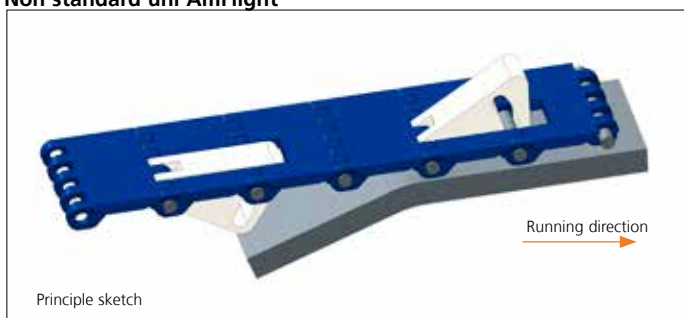

Other non standard option: See uni AmFlight Overview.

## Sprocket

No of teeth	Bore size										Overall diameter		Pitch-diameter		Hub-diameter		Dimension A		Dimension B		Single row/One way	Double row/Two way	Molded PA6 LG	Machined PA6 N
	Pilot bore		1.00		1.18		1.25		1.50															
	mm	in	25.4	30.0	31.8	38.1	40.0	60.0	63.5	90.0	mm	in	mm	in	mm	in	mm	in	mm	in				
Z06	✓	●	●	●	■	●	■				99.5	3.92	101.6	4.00	65.0	2.56	36.0	1.42	59.3	2.33	✓	✓		
Z08	✓	●	●	●	■	●	■	■			132.9	5.23	132.8	5.23	70.0	2.75	53.3	2.10	74.9	2.94	✓	✓ <sup>1</sup>	✓	
Z10	✓		●	●	●	■	■	■	■	■	166.3	6.55	164.4	6.47	<sup>1</sup> 70.0 <sup>2</sup> 120.0	2.75 4.72	70.2	2.76	90.7	3.57	✓	✓	✓	
Z12	✓		●	●	●	■	■	■	■	■	198.6	7.82	196.3	7.73	<sup>1</sup> 70.0 <sup>2</sup> 120.0 <sup>3</sup> 164.0	2.75 4.72 6.45	86.8 86.8	3.42 3.42	106.6 106.6	4.19 4.19	✓ <sup>1+2</sup>	✓ <sup>2+3</sup>	✓	
Z16	✓		●	●	●	■	■	■	■	■	263.8	10.39	260.4	10.25	<sup>1</sup> 150.0 <sup>2</sup> 164.0 <sup>3</sup> 200.0	5.90 6.45 7.87	119.7	4.71	138.7	5.46	✓ <sup>1</sup>	✓ <sup>2+3</sup>	✓	✓

● Molded sprocket   ■ Molded sprocket   ■ Machined sprocket



Other sprocket sizes are available upon request.  
 Other bore sizes on sprockets are available upon request.  
 Round bores are always delivered with keyway.  
 Max. load per sprocket shown does not take bore size into account.  
 Please also ensure that sufficient size shaft is chosen for corresponding load.  
 Width of tooth = Single row: 9.5 mm (0.37 in)  
 = Double row: 17.8 mm (0.70 in)  
 Width of One-part sprocket = Single row: 42.3 mm (1.66 in)  
 = Double row: 42.3 mm (1.66 in)  
 = <sup>3</sup>Double row: 50.0 mm (1.96 in)

## uni UltraClean Two-Part Sprocket

No. of teeth	Bore size				Overall diameter		Pitch-diameter		Hub-diameter		Dimension A		Dimension B		Single row/One way	Moulded PA6 W
	in	1.50	1.57	2.36												
	mm	38.1	40.0	60.0	mm	in	mm	in	mm	in	mm	in	mm	in		
Z8		■	■		132.9	5.23	132.8	5.23	80.0	3.15	53.3	2.10	74.9	2.94	✓	✓
Z10		■	■	■	166.3	6.55	164.4	6.47	<sup>1</sup> 126.0 <sup>2</sup> 118.0	<sup>1</sup> 4.96 <sup>2</sup> 4.65	70.2	2.76	90.7	3.57	✓	✓
Z12		■	■	■	198.6	7.82	196.3	7.73	<sup>1</sup> 126.0 <sup>2</sup> 118.0	<sup>1</sup> 4.96 <sup>2</sup> 4.65	86.8	3.42	106.6	4.19	✓	✓

■ Moulded uni UltraClean TwoPart Sprocket

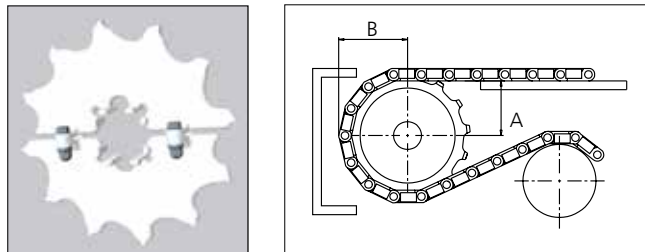

Width of UltraClean Two-part sprocket = Single row: 44.0 mm (1.73 in)  
 Width of UltraClean Two-part sprocket, tooth = Single row: 9.5 mm (0.37 in)

uni Retainer Rings: See uni Retainer Ring data sheet.  
 For correct sprocket position: See uni Assembly Instructions for uni MPB.  
 For more detailed sprocket information. contact Customer Service.

uni MPB 18/2019:03.15



Expert advice, quality solutions and local service for all your belting needs  
[www.ammeraalbeltech.com](http://www.ammeraalbeltech.com)

**Ammeraal Beltech Modular A/S**  
 Hjulmagervej 21  
 DK-7100 Vejle

T +45 7572 3100  
 F +45 7572 3348  
 admin@unichains.com  
 www.unichains.com

This information is subject to alteration due to continuous development. Ammeraal Beltech will not be held liable for the incorrect use of the above stated information. This information replaces previous information. All activities performed and services rendered by Ammeraal Beltech are subject to general terms and conditions of sale and delivery, as applied by its operating companies.



# Plastic Modular Belt

Series **uni MPB** Type **20%**

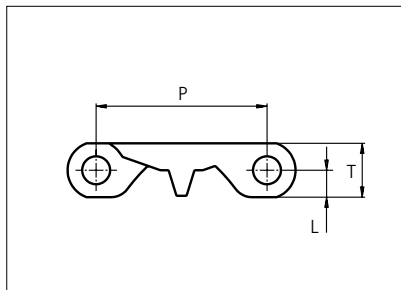

Straight running belt  
 Nominal pitch: 50.8 mm (2.00 in)  
 Surface type: Flat  
 Surface opening: 20%  
 Backflex radius: 65.0 mm (2.6 in)  
 Pin diameter: 8 mm (0.31 in)

Belt material & color	PP <b>W</b>	PE-I <b>N</b>	mm	in	mm	in
	Pin material & color	PP <b>W</b>				
			50.8	2.00	16.0	0.63
			<b>L</b>	8.0	0.31	-

Non standard material and color: See uni Material and Color Overview.

Alternative pin and lock materials: Pin: PA6.6 **N** PP **W** PE **W** PBT **LG** SS304 Lockpin: PA6.6 **B** PBT **LG** Trilock: PA6.6 **N**

Belt width		Permissible tensile force (Belt/pin material)				Belt weight (Belt/pin material)				*Min. No. drive sprocket per shaft	Number of wear strips (Min. No.)	
		PP/PP		PE-I/PE		PP/PP		PE-I/PE			**Carry (pcs)	**Return (pcs)
mm	in	N	lbf	N	lbf	kg/m	lb/ft	kg/m	lb/ft			
68	2.7	1088	245	884	199	0.5	0.34	0.5	0.36	2	2	2
84	3.3	1341	302	1090	245	0.6	0.42	0.7	0.45	2	2	2
151	5.9	2416	543	1963	441	1.1	0.75	1.2	0.80	2	2	2
185	7.3	2953	664	2399	539	1.4	0.92	1.5	0.98	2	2	2
202	8.0	3232	727	2626	590	1.5	1.00	1.6	1.07	2	2	2
252	9.9	4032	906	3276	736	1.9	1.25	2.0	1.34	2	2	2
302	11.9	4832	1086	3926	883	2.2	1.50	2.4	1.60	3	3	2
353	13.9	5648	1270	4589	1032	2.6	1.76	2.8	1.87	3	3	2
403	15.9	6448	1450	5239	1178	3.0	2.00	3.2	2.14	3	3	2
453	17.8	7248	1629	5889	1324	3.4	2.25	3.6	2.41	4	4	2
504	19.8	8064	1813	6552	1473	3.7	2.51	4.0	2.68	4	4	2
554	21.8	8864	1993	7202	1619	4.1	2.76	4.4	2.94	4	4	2
604	23.8	9664	2172	7852	1765	4.5	3.00	4.8	3.21	5	5	3

Additional standard belt widths are available in steps of 50.3 mm (1.98 in.) Additional non-standard belt widths are available in steps of 16.8 mm (0.66 in).

1963	77.3	31408	7061	25519	5737	14.5	9.76	15.5	10.42	14	14	7
------	------	-------	------	-------	------	------	------	------	-------	----	----	---

Additional standard belt widths are available in steps of 50.3 mm (1.98 in.) Additional non-standard belt widths are available in steps of 16.8 mm (0.66 in).

2970	116.9	47520	10682	38610	8680	22.0	14.77	23.5	15.77	20	20	10
------	-------	-------	-------	-------	------	------	-------	------	-------	----	----	----

General belt tolerance is +0/-0.4% at 23°C/73°F and 50% RH. For exact belt width contact Customer Service. Non standard belt width on request.

\*Max. Load per Drive Sprocket. Belt material: PP with snub roller 2000 N (450 lbf) without snub roller 1250 N (281 lbf).

\*\*Max. Spacing between wear strips, Carry: 152 mm (6 in); Return: 304 mm (12 in).

= Single Link



STANDARD

STRAIGHT RUNNING

PITCH 50.8 MM/2.00 IN

## Accessories

### Rubber Top

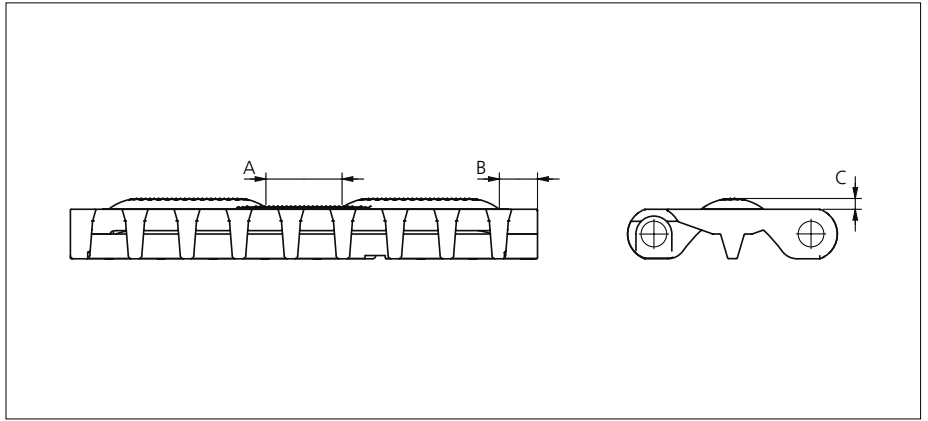

Type	Belt Material & color	Rubber Material & color	A		B		C		Link size	Width	
			mm	in	mm	in	mm	in		mm	in
Curved Rough	POM-DI <b>W</b>	01 <b>N</b>	24.0	0.94	10.0	0.39	3.5	0.14	K600	151.0	5.94

Non Standard material and color: See uni Material and Color Overview.

## Accessories

### Flight



See separate uni MPB series Flight datasheet.

## Accessories

### Side Guard

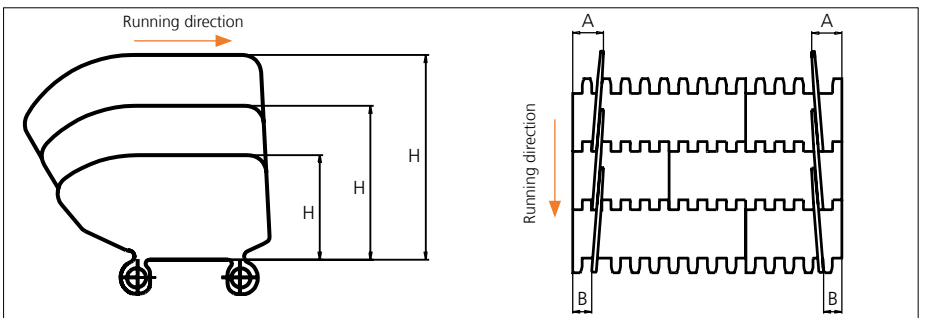

Type	Side Guard Material & color	H		A		B	
		mm	in	mm	in	mm	in
Closed	PE-I <b>B</b> <b>N</b> PP-I <b>W</b> <b>B</b>	50.8	2.00	32.0	1.26	16.0	0.63
		76.2	3.00				
		101.6	4.00				

\*34.0 mm (1.34 in) combined with flight. Increment: 8.4 mm (0.33 in).

Note: Backflex radius when Side Guard are used: 200.0 mm (7.90 in)



## Accessories

### Tab

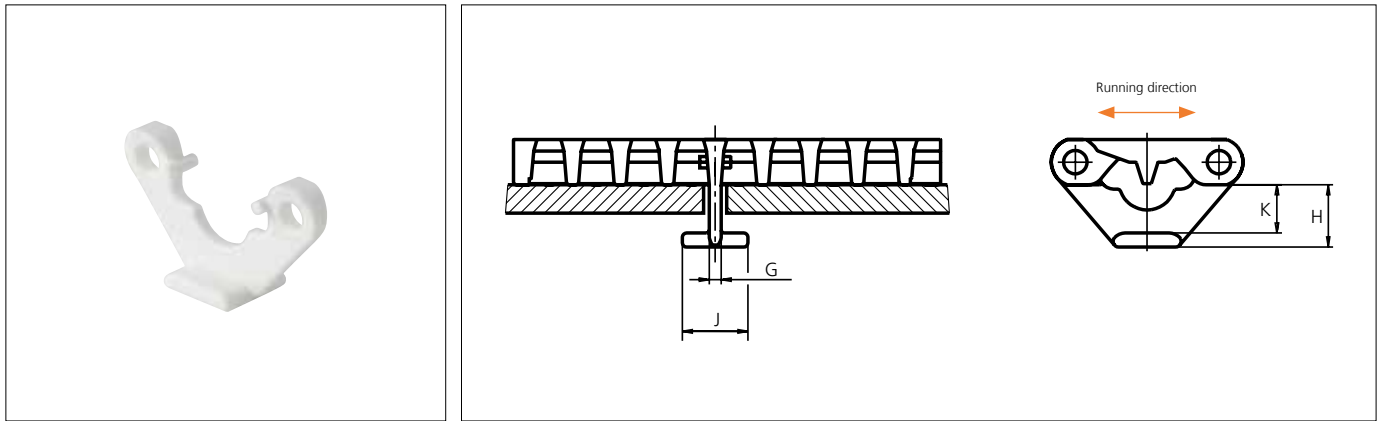

Type	Tab Material & color	G		J		K		H	
		mm	in	mm	in	mm	in	mm	in
Bottom Hold Down	POM-DI <b>w</b>	4.2	0.17	23.2	0.91	17.0	0.67	22.0	0.87

Note: When using taps, please verify sufficient clearance to the shaft. Max. shaft diameter = Sprocket pitch diameter - 63.5 mm (2.50 in). When using square shafts, please verify that the diagonal does not exceed max. diameter. Example: Sprocket z = 6: Max. shaft diameter 101.6 - 63.5 =  $\varnothing$ 38.1 mm (4.00 - 2.50 =  $\varnothing$ 1.4 in).

Note: When using a belt system with tabs, the temperature should be constant. Please note that the tabs are not always placed in the middle of the belt.

Non Standard material and color: See uni Material and Color Overview.

## Accessories

### Non standard uni AmFlight

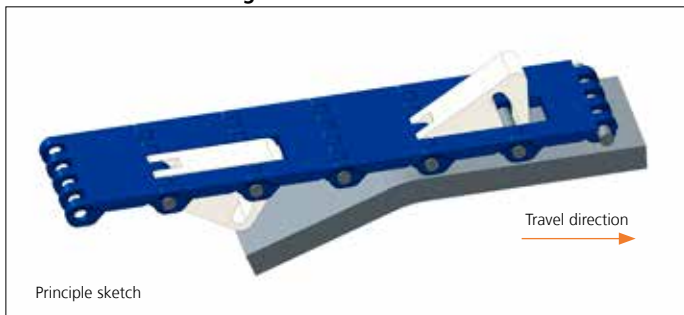

Other non standard option: See uni Amflight Overview.

## Sprocket

No of teeth	Bore size										Overall diameter		Pitch-diameter		Hub-diameter		Dimension A		Dimension B		Single row/One way	Double row/Two way	Molded	Machined
	Pilot bore		1.00		1.18		1.25		1.50															
	mm	in	25.4	30.0	31.8	38.1	40.0	60.0	63.5	90.0	mm	in	mm	in	mm	in	mm	in						
Z06	✓	●	●	●	■	●	■				99.5	3.92	101.6	4.00	65.0	2.56	36.0	1.42	59.3	2.33	✓	✓		
Z08	✓	●	●	●	■	●	■	■			132.9	5.23	132.8	5.23	70.0	2.75	53.3	2.10	74.9	2.94	✓	✓ <sup>1</sup>	✓	
Z10	✓		●	●	●	■	■	■	■	■	166.3	6.55	164.4	6.47	<sup>1</sup> 70.0 <sup>2</sup> 120.0	2.75 4.72	70.2	2.76	90.7	3.57	✓	✓	✓	
Z12	✓		●	●	●	■	■	■	■	■	198.6	7.82	196.3	7.73	<sup>1</sup> 70.0 <sup>2</sup> 120.0 <sup>3</sup> 164.0	2.75 4.72 6.45	86.8 86.8	3.42 3.42	106.6 106.6	4.19 4.19	✓ <sup>1+2</sup>	✓ <sup>2+3</sup>	✓	
Z16	✓	●	●	●	■	■	■	■	■	■	263.8	10.39	260.4	10.25	<sup>1</sup> 150.0 <sup>2</sup> 164.0 <sup>3</sup> 200.0	5.90 6.45 7.87			138.7	5.46	✓ <sup>1</sup>	✓ <sup>2+3</sup>	✓	✓

● Molded sprocket    ■ Molded sprocket    ■ Machined sprocket



Other sprocket sizes are available upon request.  
 Other bore sizes on sprockets are available upon request.  
 Round bores are always delivered with keyway.  
 Max. load per sprocket shown does not take bore size into account.  
 Please also ensure that sufficient size shaft is chosen for corresponding load.  
 Width of tooth = Single row: 9.5 mm (0.37 in)  
 = Double row: 17.8 mm (0.70 in)  
 Width of One-part sprocket = Single row: 42.3 mm (1.66 in)  
 = Double row: 42.3 mm (1.66 in)  
 = <sup>3</sup>Double row: 50.0 mm (1.96 in)

## uni UltraClean Two-Part Sprocket

No. of teeth	Bore size				Overall diameter		Pitch-diameter		Hub-diameter		Dimension A		Dimension B		Single row/One way	Moulded
	in	1.50	1.57	2.36												
	mm	38.1	40.0	60.0	mm	in	mm	in	mm	in	mm	in				
Z8		■	■		132.9	5.23	132.8	5.23	80.0	3.15	53.3	2.10	74.9	2.94	✓	✓
Z10		■	■	■	166.3	6.55	164.4	6.47	<sup>1</sup> 126.0 <sup>2</sup> 118.0	<sup>1</sup> 4.96 <sup>2</sup> 4.65	70.2	2.76	90.7	3.57	✓	✓
Z12		■	■	■	198.6	7.82	196.3	7.73	<sup>1</sup> 126.0 <sup>2</sup> 118.0	<sup>1</sup> 4.96 <sup>2</sup> 4.65	86.8	3.42	106.6	4.19	✓	✓

■ Moulded uni UltraClean TwoPart Sprocket

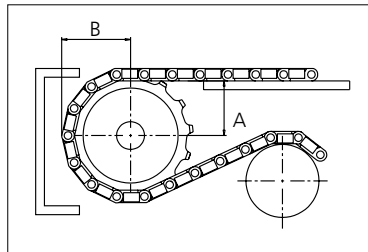

Width of UltraClean Two-part sprocket = Single row: 44.0 mm (1.73 in)  
 Width of UltraClean Two-part sprocket, tooth = Single row: 9.5 mm (0.37 in)

uni Retainer Rings: See uni Retainer Ring data sheet.  
 For correct sprocket position: See uni Assembly Instructions for uni MPB.  
 For more detailed sprocket information. contact Customer Service.

uni MPB 20/2019:02.07



Expert advice, quality solutions and local service for all your belting needs  
[www.ammeraalbeltech.com](http://www.ammeraalbeltech.com)

**Ammeraal Beltech Modular A/S**  
 Hjulmagervej 21  
 DK-7100 Vejle

T +45 7572 3100  
 F +45 7572 3348  
 admin@unichains.com  
 www.unichains.com

This information is subject to alteration due to continuous development. Ammeraal Beltech will not be held liable for the incorrect use of the above stated information. This information replaces previous information. All activities performed and services rendered by Ammeraal Beltech are subject to general terms and conditions of sale and delivery, as applied by its operating companies.



# Plastic Modular Belt

Series **uni MPB** Type **22%**

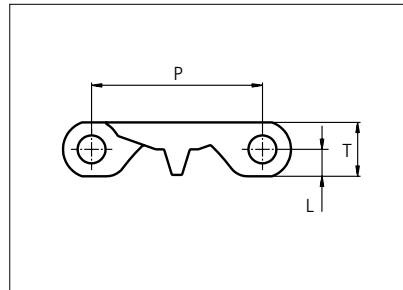

Straight running belt  
 Nominal pitch: 50.8 mm (2.00 in)  
 Surface type: Flat  
 Surface opening: 22%  
 Backflex radius: 65.0 mm (2.6 in)  
 Pin diameter: 8 mm (0.31 in)

Belt material & color	PP <b>W</b>	PE-I <b>N B</b>	mm	in	mm	in		
			<b>P (Nominal)</b>	50.8	2.00	<b>T</b>	16.0	0.63
Pin material & color	PP <b>W</b>	PE <b>W</b>	<b>L</b>	8.0	0.31	-	-	-

Non standard material and color: See uni Material and Color Overview.

Alternative pin and lock materials: Pin: PA6.6 **N W** PE **W** PBT **LG** SS304 Lockpin: PA6.6 **B** PBT **LG** Trilock: PA6.6 **N**

Belt width		Permissible tensile force (Belt/pin material)				Belt weight (Belt/pin material)				*Min. No. drive sprocket per shaft	Number of wear strips (Min. No.)	
		PP/PP		PE-I/PE		PP/PP		PE-I/PE			**Carry (pcs)	**Return (pcs)
mm	in	N	lbf	N	lbf	kg/m	lb/ft	kg/m	lb/ft			
84	3.3	1341	302	1090	245	0.6	0.41	0.6	0.43	2	2	2
151	5.9	2416	543	1963	441	1.1	0.73	1.1	0.77	2	2	2
185	7.3	2953	664	2399	539	1.3	0.89	1.4	0.94	2	2	2
202	8.0	3232	727	2626	590	1.5	0.98	1.5	1.03	2	2	2
252	9.9	4032	906	3276	736	1.8	1.22	1.9	1.29	2	2	2
302	11.9	4832	1086	3926	883	2.2	1.46	2.3	1.54	3	3	2
353	13.9	5648	1270	4589	1032	2.5	1.71	2.7	1.80	3	3	2
403	15.9	6448	1450	5239	1178	2.9	1.95	3.1	2.06	3	3	2
453	17.8	7248	1629	5889	1324	3.3	2.19	3.4	2.31	4	4	2
504	19.8	8064	1813	6552	1473	3.6	2.44	3.8	2.57	4	4	2
554	21.8	8864	1993	7202	1619	4.0	2.68	4.2	2.83	4	4	2
604	23.8	9664	2172	7852	1765	4.3	2.92	4.6	3.08	5	5	3
655	25.8	10480	2356	8515	1914	4.7	3.17	5.0	3.35	5	5	3

Additional standard belt widths are available in steps of 50.3 mm (1.98 in.) Additional non-standard belt widths are available in steps of 16.8 mm (0.66 in.)

1963	77.3	31408	7061	25519	5737	14.1	9.50	14.9	10.03	14	14	7
------	------	-------	------	-------	------	------	------	------	-------	----	----	---

Additional standard belt widths are available in steps of 50.3 mm (1.98 in.) Additional non-standard belt widths are available in steps of 16.8 mm (0.66 in.)

2970	116.9	47520	10682	38610	8680	21.4	14.37	22.6	15.17	20	20	10
------	-------	-------	-------	-------	------	------	-------	------	-------	----	----	----

General belt tolerance is +0/-0.4% at 23°C/73°F and 50% RH. For exact belt width contact Customer Service. Non standard belt width on request.

\*Max. Load per Drive Sprocket. Belt material: PP with snub roller 2000 N (450 lbf) without snub roller 1250 N (281 lbf)

\*\*Max. Spacing between wear strips, Carry: 152 mm (6 in); Return: 304 mm (12 in).

= Single Link



STANDARD

STRAIGHT RUNNING

PITCH 50.8 MM/2.00 IN

## Accessories

### Rubber Top

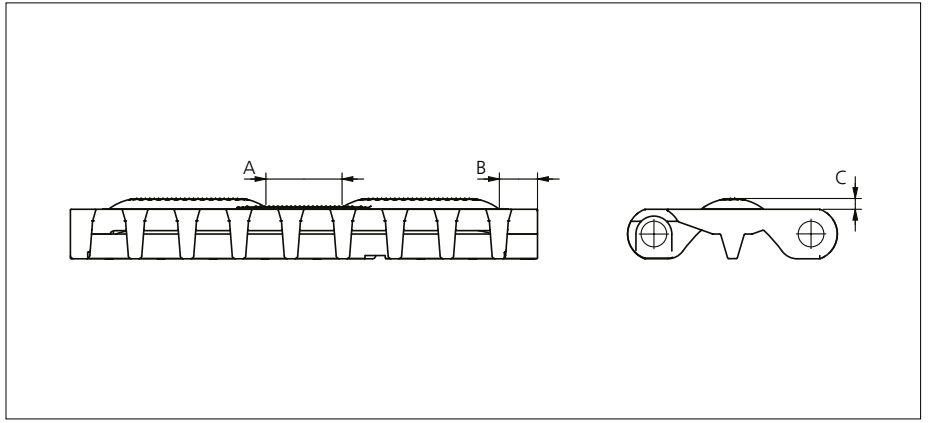

Type	Belt Material & color	Rubber Material & color	A		B		C		Link size	Width	
			mm	in	mm	in	mm	in		mm	in
Curved Rough	POM-DI <b>W</b>	01 <b>N</b>	24.0	0.94	10.0	0.39	3.5	0.14	K600	151.0	5.94

Non Standard material and color: See uni Material and Color Overview.

## Accessories

### Flight



See separate uni MPB series Flight datasheet.

## Accessories

### Side Guard

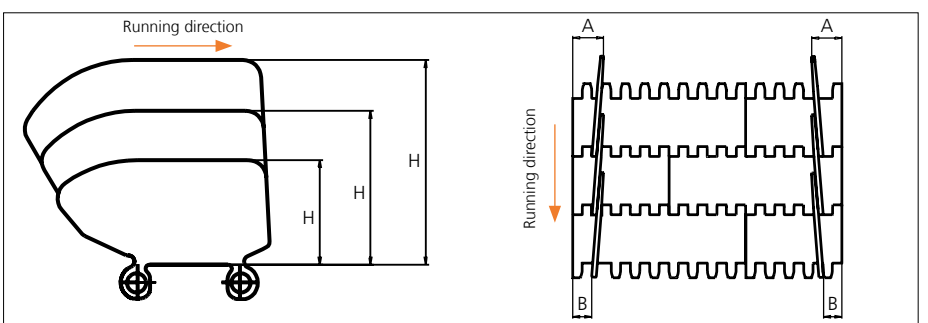

Type	Side Guard Material & color	H		A		B	
		mm	in	mm	in	mm	in
Closed	PE-I <b>B</b> <b>N</b>	50.8	2.00	32.0	1.26	16.0	0.63
	PP-I <b>W</b> <b>B</b>	76.2	3.00				
		101.6	4.00				

\*34.0 mm (1.34 in) combined with flight. Increment: 8.4 mm (0.33 in).

Note: Backflex radius when Side Guard are used: 200.0 mm (7.90 in)

## Accessories

### Tab

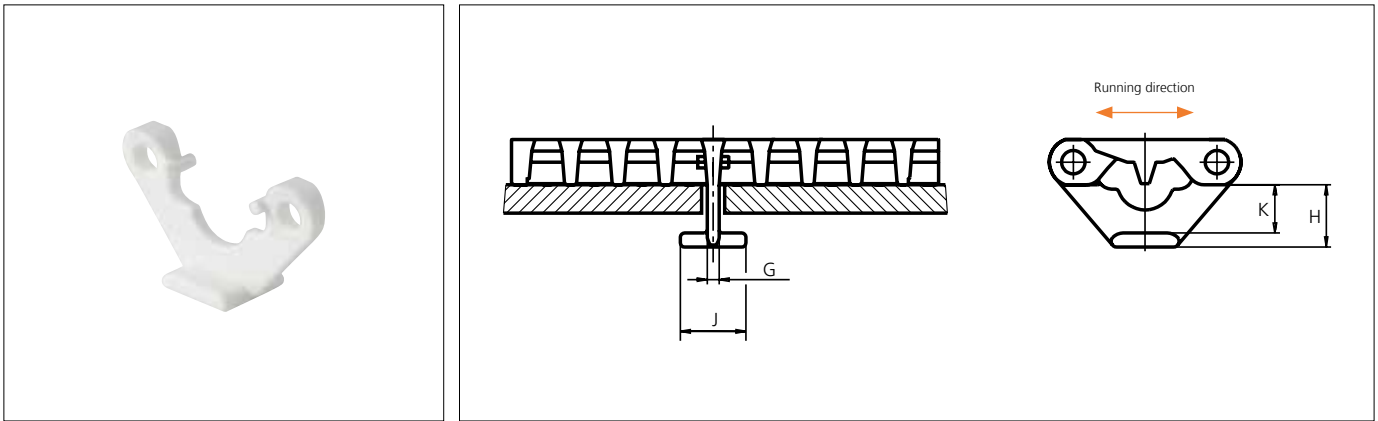

Type	Tab Material & color	G		J		K		H	
		mm	in	mm	in	mm	in	mm	in
Bottom Hold Down	POM-DI <b>w</b>	4.2	0.17	23.2	0.91	17.0	0.67	22.0	0.87

Note: When using taps, please verify sufficient clearance to the shaft. Max. shaft diameter = Sprocket pitch diameter - 63.5 mm (2.50 in). When using square shafts, please verify that the diagonal does not exceed max. diameter. Example: Sprocket z = 6: Max. shaft diameter 101.6 - 63.5 = ø38.1 mm (4.00 - 2.50 = ø1.4 in).

Note: When using a belt system with tabs, the temperature should be constant. Please note that the tabs are not always placed in the middle of the belt.

Non Standard material and color: See uni Material and Color Overview.

## Accessories

### Non standard uni AmFlight

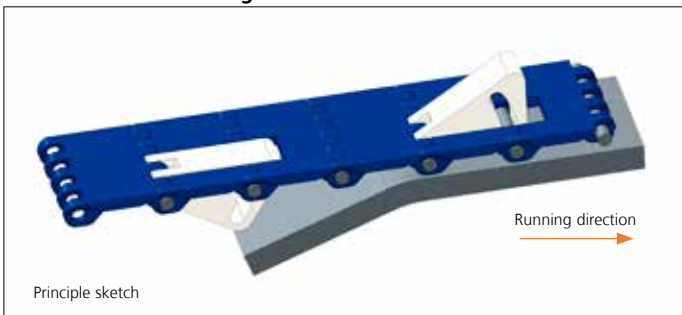

Other non standard option: See uni Amflight Overview.

## Sprocket

No of teeth	Bore size										Overall diameter		Pitch-diameter		Hub-diameter		Dimension A		Dimension B		Single row/One way	Double row/Two way	Molded PA6 LG	Machined PA6 N		
	Pilot bore		1.00		1.18		1.25		1.50																	
	mm	in	25.4	30.0	31.8	38.1	40.0	60.0	63.5	90.0	mm	in	mm	in	mm	in	mm	in								
Z06	✓	●	●	●	■	●	■				99.5	3.92	101.6	4.00	65.0	2.56	36.0	1.42	59.3	2.33	✓	✓				
Z08	✓	●	●	●	■	●	■	■			132.9	5.23	132.8	5.23	70.0	2.75	53.3	2.10	74.9	2.94	✓	1✓	✓			
Z10	✓		1●	1●	1●	1■	1■	2■	2■		166.3	6.55	164.4	6.47	<sup>1</sup> 70.0 <sup>2</sup> 120.0	2.75 4.72	70.2	2.76	90.7	3.57	✓	✓	✓			
Z12	✓		1●	1●	1●	1■	1■	2■	2■	3■	198.6	7.82	196.3	7.73	<sup>1</sup> 70.0 <sup>2</sup> 120.0 <sup>3</sup> 164.0	2.75 4.72 6.45	86.8 86.8	3.42 3.42	106.6 106.6	4.19 4.19	<sup>1+2</sup> ✓	<sup>2+3</sup> ✓	✓			
Z16	✓		2● 1●	2● 1●	2● 1●	2■ 1■	2■ 1■	3■ 1■	2■ 1■	3■	263.8	10.39	260.4	10.25	<sup>1</sup> 150.0 <sup>2</sup> 164.0 <sup>3</sup> 200.0	5.90 6.45 7.87			119.7	4.71	138.7	5.46	<sup>1</sup> ✓	<sup>2+3</sup> ✓	✓	✓

● Molded sprocket   ■ Molded sprocket   ■ Machined sprocket



Other sprocket sizes are available upon request.  
 Other bore sizes on sprockets are available upon request.  
 Round bores are always delivered with keyway.  
 Max. load per sprocket shown does not take bore size into account.  
 Please also ensure that sufficient size shaft is chosen for corresponding load.  
 Width of tooth = Single row: 9.5 mm (0.37 in)  
 = Double row: 17.8 mm (0.70 in)  
 Width of One-part sprocket = Single row: 42.3 mm (1.66 in)  
 = Double row: 42.3 mm (1.66 in)  
 = <sup>3</sup>Double row: 50.0 mm (1.96 in)

## uni UltraClean Two-Part Sprocket

No. of teeth	Bore size				Overall diameter		Pitch-diameter		Hub-diameter		Dimension A		Dimension B		Single row/One way	Moulded PA6 W
	in	1.50	1.57	2.36												
	mm	38.1	40.0	60.0	mm	in	mm	in	mm	in	mm	in				
Z8		■	■		132.9	5.23	132.8	5.23	80.0	3.15	53.3	2.10	74.9	2.94	✓	✓
Z10		1■	1■	2■	166.3	6.55	164.4	6.47	<sup>1</sup> 126.0 <sup>2</sup> 118.0	<sup>1</sup> 4.96 <sup>2</sup> 4.65	70.2	2.76	90.7	3.57	✓	✓
Z12		1■	1■	2■	198.6	7.82	196.3	7.73	<sup>1</sup> 126.0 <sup>2</sup> 118.0	<sup>1</sup> 4.96 <sup>2</sup> 4.65	86.8	3.42	106.6	4.19	✓	✓

■ Moulded uni UltraClean TwoPart Sprocket

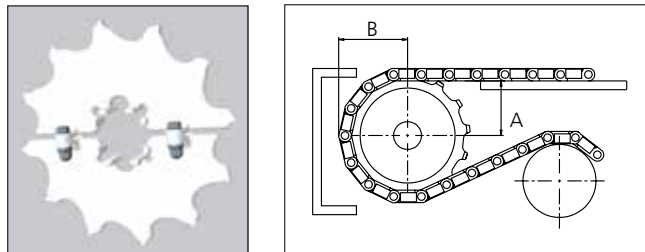

Width of UltraClean Two-part sprocket = Single row: 44.0 mm (1.73 in)  
 Width of UltraClean Two-part sprocket, tooth = Single row: 9.5 mm (0.37 in)

uni Retainer Rings: See uni Retainer Ring data sheet.  
 For correct sprocket position: See uni Assembly Instructions for uni MPB.  
 For more detailed sprocket information. contact Customer Service.

uni MPB 20/2019:03:04



Expert advice, quality solutions and local service for all your belting needs  
[www.ammeraalbeltech.com](http://www.ammeraalbeltech.com)

**Ammeraal Beltech Modular A/S**  
 Hjulmagervej 21  
 DK-7100 Vejle

T +45 7572 3100  
 F +45 7572 3348  
 admin@unichains.com  
 www.unichains.com

This information is subject to alteration due to continuous development. Ammeraal Beltech will not be held liable for the incorrect use of the above stated information. This information replaces previous information. All activities performed and services rendered by Ammeraal Beltech are subject to general terms and conditions of sale and delivery, as applied by its operating companies.



# Plastic Modular Belt

## uni MPB Pop-up flight

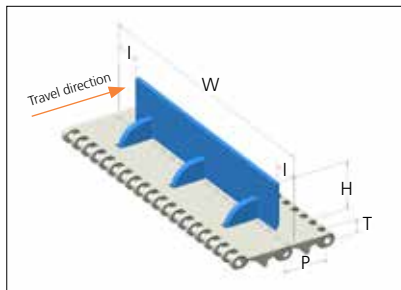
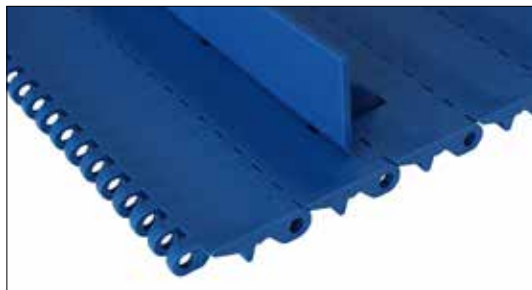

Straight running elevator belt  
 Nominal pitch: 50.8 mm (2.00 in)  
 Surface type: Flat  
 Surface opening: Closed  
 Backflex radius: 100.0 mm (3.90 in) min  
 Pin diameter: 8.0 mm (0.31 in)

<b>Belt material &amp; color</b>	PP <span style="border: 1px solid black; padding: 0 2px;">W</span> <span style="border: 1px solid black; padding: 0 2px;">B</span>	PE-I <span style="border: 1px solid black; padding: 0 2px;">N</span> <span style="border: 1px solid black; padding: 0 2px;">B</span>		<b>mm</b>	<b>in</b>		<b>mm</b>	<b>in</b>	
<b>Pin material &amp; color</b>	PP <span style="border: 1px solid black; padding: 0 2px;">W</span>	PE <span style="border: 1px solid black; padding: 0 2px;">W</span>		<b>H</b>	54.8	2.16	<b>T</b>	16.0	0.63
<b>Flight material &amp; color</b>	PP-I <span style="border: 1px solid black; padding: 0 2px;">W</span> <span style="border: 1px solid black; padding: 0 2px;">B</span>	PE-I <span style="border: 1px solid black; padding: 0 2px;">W</span> <span style="border: 1px solid black; padding: 0 2px;">B</span>		<b>I</b>	34.0	1.34	-	-	-
				<b>P</b>	50.8	2.00	-	-	-

Non standard material and color: See uni Material and Color Overview.

Alternative pin and lock materials: Pin: PA6.6 N PP W PE W PBT LG SS304

Lockpin: PA6.6 B PBT LG

### Belt load capacity

Belt dimensions						Permissible tensile force (Belt/pin material)				Maximum product load per flight row	
Belt width (W)		Indents (I)*		Flight width (B)		PP/PP		PE-I/PE			
mm	in	mm	in	mm	in	N	lbf	N	lbf	Kg	Lbs
302	11.9	34	1.34	234	9.2	4832	1086	3926	883	12	27
353	13.9	34	1.34	285	11.2	5648	1270	4589	1032	14	31
403	15.9	34	1.34	335	13.2	6448	1450	5239	1178	16	36
453	17.8	34	1.34	385	15.2	7248	1629	5889	1324	18	40
504	19.8	34	1.34	436	19.2	8064	1813	6552	1473	20	44
554	21.8	34	1.34	486	19.1	8864	1993	7202	1619	22	49
604	23.8	34	1.34	536	21.1	9664	2173	7852	1765	24	53

General width tolerance is +0/-0.4% at 23°C/73°F. For other widths contact Customer Service.

\*Standard indent 34.0 mm (1.34 in), other indents upon request.



STANDARD

STRAIGHT RUNNING

PITCH 50.8 MM/2.00 IN

Belt dimensions		Base belt weight (Belt/pin material)				ADD weight per flight row				Construction information		
										Min. no drive sprockets*	No flight cams/ activation wearstrips	Min number of support wearstrips
Belt width (W)		PP/PP		PE-I/PE		PP-I/PP		PE-I/PE		Pieces	Pieces	Pieces
mm	in	Kg/m	lb/ft	Kg/m	lb/ft	Kg/m	lb/ft	Kg/m	lb/ft			
302	11.9	2.5	1.7	2.7	1.8	0.08	0.17	0.08	0.18	2	3	2
353	13.9	2.9	2.0	3.1	2.1	0.10	0.22	0.10	0.23	2	4	2
403	15.9	3.3	2.2	3.5	2.4	0.12	0.26	0.13	0.28	2	4	2
453	17.8	3.8	2.5	4.0	2.7	0.13	0.28	0.14	0.30	3	5	2
504	19.8	4.2	2.8	4.4	3.0	0.14	0.31	0.15	0.33	3	5	2
554	21.8	4.6	3.1	4.9	3.3	0.16	0.35	0.17	0.38	4	6	2
604	23.8	5.0	3.4	5.3	3.6	0.17	0.38	0.18	0.40	4	6	2

\*Max. Load per Drive Sprocket. Belt material: POM-DI with snub roller 2000 N (450 lbf) without snub roller 1250 N (281 lbf)

### Placing of activation wearstrips

Belt dimensions						Activation wearstrips Distance from belt left hand edge											
Belt width (W)		Indents* (I)		Flight width (B)		A1		A2		A3		A4		A5		A6	
mm	in	mm	in	mm	in	mm	in	mm	in	mm	in	mm	in	mm	in	mm	in
302	11.9	34	1.34	234	9.2	46	1.81	147	5.79	248	9.76	-	-	-	-	-	-
353	13.9	34	1.34	285	11.2	63	2.48	164	6.46	197	7.76	298	11.73	-	-	-	-
403	15.9	34	1.34	335	13.2	63	2.48	164	6.46	231	9.09	332	13.07	-	-	-	-
453	17.8	34	1.34	385	15.2	46	1.81	147	5.79	248	9.76	298	11.73	399	15.71	-	-
504	19.8	34	1.34	436	19.2	63	2.48	164	6.46	265	10.43	332	13.07	433	17.05	-	-
554	21.8	34	1.34	486	19.1	63	2.48	164	6.46	265	10.43	298	11.73	399	15.71	500	19.67
604	23.8	34	1.34	536	21.1	63	2.48	164	6.46	265	10.43	332	13.07	433	17.05	533	20.98

\*Standard indent 34.0 mm (1.34 in), other indents upon request.

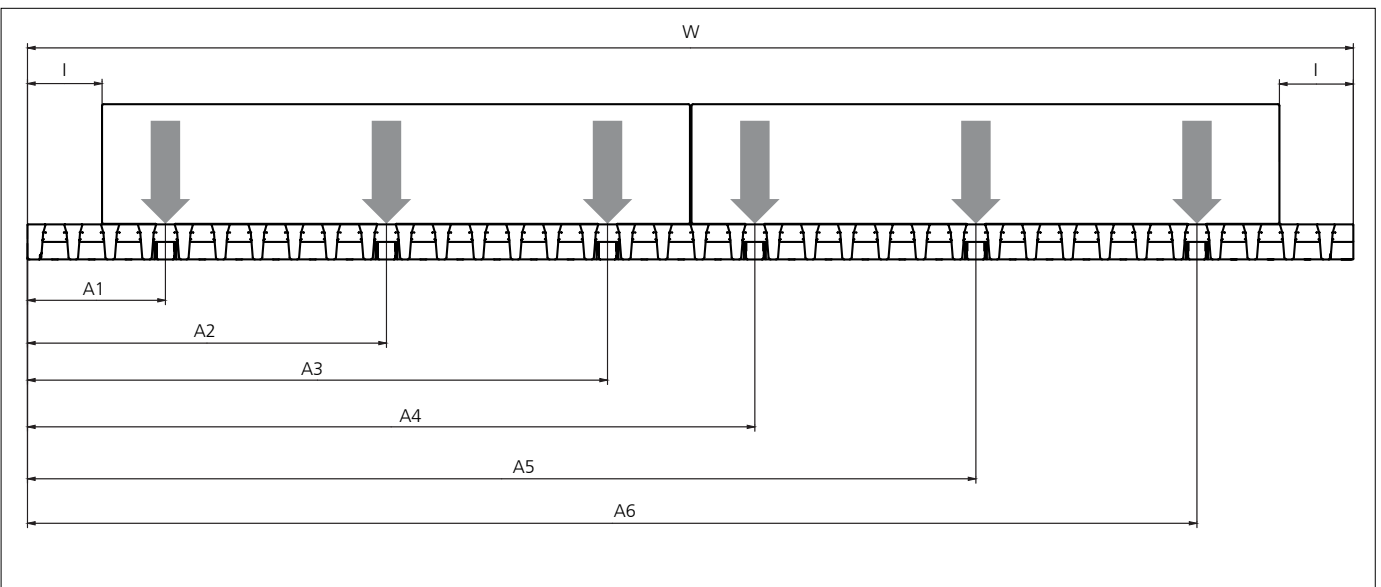

↓ = Placing of activation wearstrip

Dimensions for Pop-up flight system are from left hand edge of belt, looking down from top of belt with travel direction moving away from viewing point.



## Placing of sprockets

Belt dimensions						Min. No drive sprockets**	Sprocket Position Distance from belt left hand edge							
Belt width (W)		Indents* (I)		Flight width (B)			S1		S2		S3		S4	
mm	in	mm	in	mm	in		mm	in	mm	in	mm	in	mm	in
302	11.9	34	1.34	234	9.2	2	88	3.46	206	8.11	-	-	-	-
353	13.9	34	1.34	285	11.2	2	105	4.13	256	10.08	-	-	-	-
403	15.9	34	1.34	335	13.2	2	105	4.13	290	11.42	-	-	-	-
453	17.8	34	1.34	385	15.2	3	88	3.46	206	8.11	357	14.06	-	-
504	19.8	34	1.34	436	19.2	3	105	4.13	223	8.78	391	15.39	-	-
554	21.8	34	1.34	486	19.1	4	105	4.13	223	8.78	357	14.06	457	18.00
604	23.8	34	1.34	536	21.1	4	105	4.13	223	8.78	374	14.72	491	19.33

\*Standard indent 34.0 mm (1.34 in), other indents upon request.

\*\*Max. Load per Drive Sprocket. Belt material: POM-DI with snub roller 2000 N (450 lbf) without snub roller 1250 N (281 lbf)

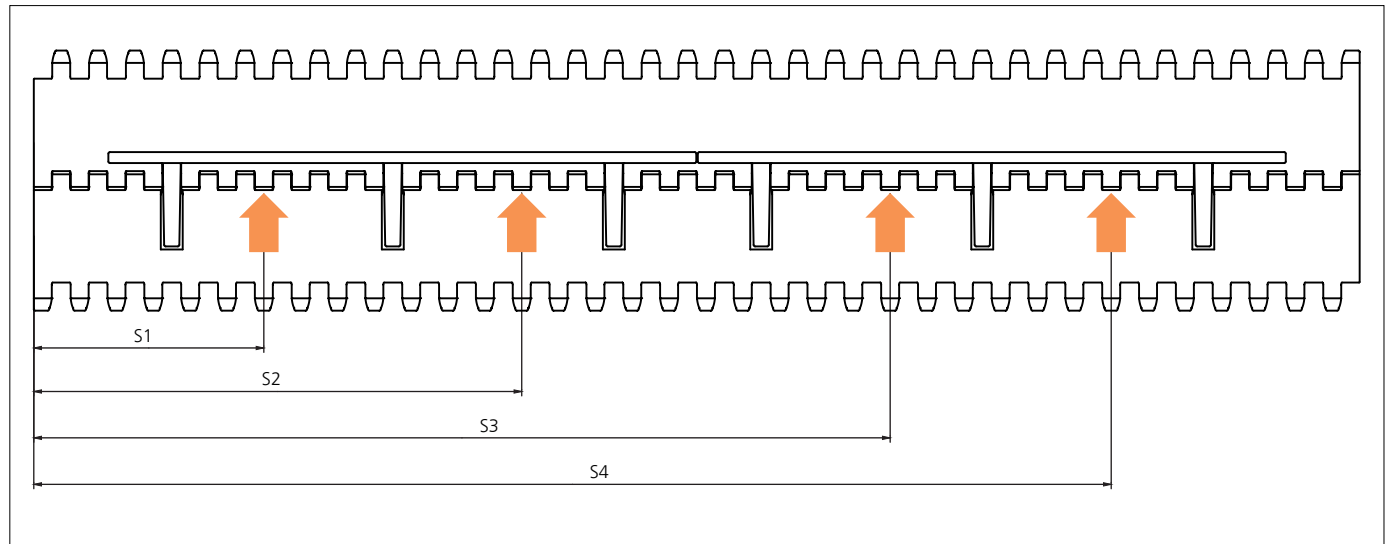

↑ = Placing of sprockets

Ensure sprockets cannot contact the Pop-up flight activation cams. These cams hinge below the belt surface when unsupported by wear-strips. If needed use extra retaining rings each side of floating sprockets to ensure they cannot contact the activation cams but can still float sideways.

## Sprocket

No of teeth	Bore size								Overall diameter		Pitch-diameter		Hub-diameter		Dimension A		Dimension B		Single row/One way	Molded	Machined
	Pilot bore	in	1.00	1.18	1.25	1.50	1.57	2.36													
	mm	25.4	30.0	31.8	38.1	40.0	60.0	63.5	mm	in	mm	in	mm	in	mm	in					
Z08	✓	●	●	●	■	■			132.9	5.23	132.8	5.23	70.0	2.75	53.3	2.10	74.9	2.94	✓	✓	
Z10	✓		●	●	■	■			166.3	6.55	164.4	6.47	70.0	2.75	70.2	2.76	90.7	3.57	✓	✓	
Z10							■	■	166.3	6.55	164.4	6.47	120.0	4.72	70.2	2.76	90.7	3.57	✓	✓	
Z12	✓		●	●	■	■			198.6	7.82	196.3	7.73	70.0	2.75	86.8	3.42	106.6	4.19	✓	✓	
Z12							■	■	198.6	7.82	196.3	7.73	120.0	4.72	86.8	3.42	106.6	4.19	✓	✓	
Z16	✓		●	●	■	■	■	■	263.8	10.39	260.4	10.25	150.0	5.90	119.7	4.71	138.7	5.46	✓		✓

● Molded sprocket    ■ Molded sprocket    ■ Machined sprocket



Other sprocket sizes are available upon request.  
 Other bore sizes on sprockets are available upon request.  
 Round bores are always delivered with keyway.  
 Max. load per sprocket shown does not take bore size into account.  
 Please also ensure that sufficient size shaft is chosen for corresponding load.  
 One way sprockets as shown above are recommended for use with Pop-up flight system.

Width of tooth = Single row: 9.5 mm (0.37 in)  
 = Double row: 17.8 mm (0.70 in)  
 Width of One-part sprocket = Single row: 42.3 mm (1.66 in)  
 = Double row: 42.3 mm (1.66 in)  
 = <sup>3</sup>Double row: 50.0 mm (1.96 in)

## uni UltraClean Two-Part Sprocket

No. of teeth	Bore size				Overall diameter		Pitch-diameter		Hub-diameter		Dimension A		Dimension B		Single row/One way	Moulded
	in	1.50	1.57	2.36												
	mm	38.1	40.0	60.0	mm	in	mm	in	mm	in	mm	in				
Z8		■	■		132.9	5.23	132.8	5.23	80.0	3.15	53.3	2.10	74.9	2.94	✓	✓
Z10		1 ■	1 ■	2 ■	166.3	6.55	164.4	6.47	<sup>1</sup> 126.0 <sup>2</sup> 118.0	<sup>1</sup> 4.96 <sup>2</sup> 4.65	70.2	2.76	90.7	3.57	✓	✓
Z12		1 ■	1 ■	2 ■	198.6	7.82	196.3	7.73	<sup>1</sup> 126.0 <sup>2</sup> 118.0	<sup>1</sup> 4.96 <sup>2</sup> 4.65	86.8	3.42	106.6	4.19	✓	✓

■ Moulded uni UltraClean TwoPart Sprocket

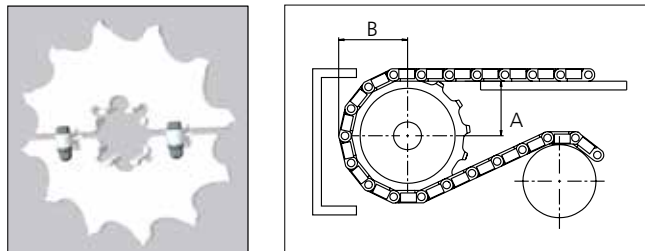

Width of UltraClean two-part sprocket = Single row: 44.0 mm (1.73 in)  
 Two way sprockets are available and can be used for conveyors which needed to reverse travel direction.

uni Retainer Rings: See uni Retainer Ring data sheet.  
 For correct sprocket position: See uni Assembly Instructions for uni MPB.  
 For more detailed sprocket information. contact Customer Service.



Expert advice, quality solutions and local service for all your belting needs  
[www.ammeraalbeltech.com](http://www.ammeraalbeltech.com)

**Global Headquarters:**  
**Ammeraal Beltech Holding B.V.**  
 P.O. Box 38, 1700 AA Heerhugowaard  
 The Netherlands

This information is subject to alteration due to continuous development. Ammeraal Beltech will not be held liable for the incorrect use of the above stated information. This information replaces previous information. All activities performed and services rendered by Ammeraal Beltech are subject to general terms and conditions of sale and delivery, as applied by its operating companies.

T +31 72 575 1212  
 F +31 72 571 6455  
[info@ammeraalbeltech.com](mailto:info@ammeraalbeltech.com)



# Plastic Modular Belt

## Accessories **uni MPB** Type **Flights**

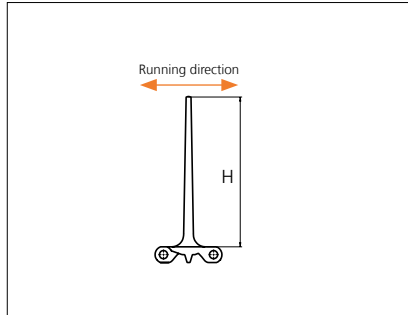

Type	Material & color	H		Link size	Width		Indent both sides			
		mm	in		mm	in	mm	in		
Flat	PE-I	5.0	0.20	K600	151.0	5.94	3.0	0.12		
	PP-I PE-I	10.0	0.39							
	POM-D PP-I PE-I	25.4	1.00				0.0	0.0		
		50.8	2.00							
		76.2	3.00							
		101.6	4.00							
		101.6	4.00						34.0*	1.34
		152.4	6.00						0.0	0.00

\*Indent only in one side.

Depending on height and spacing the use of product supports may influence the backflex radius.

STANDARD  
STRAIGHT RUNNING  
PITCH 50.8 MM/2.00 IN



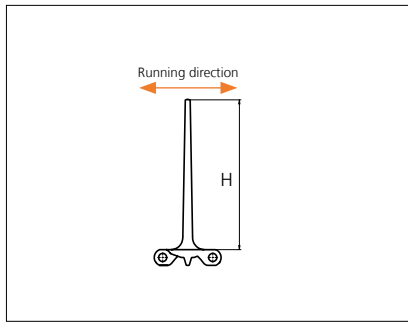
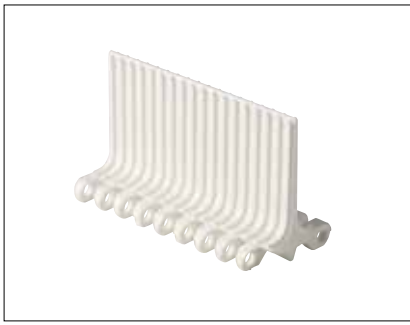

Type	Material & color	H		Link size	Width		Indent both sides	
		mm	in		mm	in	mm	in
Non Stick	PP-I <input type="checkbox"/> W <input checked="" type="checkbox"/> B	76.2	3.00	K600	151.0	5.94	0.0	0.00
	PE-I <input checked="" type="checkbox"/> B <input checked="" type="checkbox"/> N	101.6	4.00					

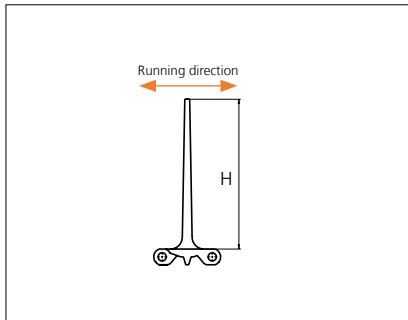

Type	Material & color	H		Link size	Width		Indent both sides	
		mm	in		mm	in	mm	in
10% Non Stick	PP-I <input type="checkbox"/> W <input checked="" type="checkbox"/> B	50.8	2.00	K600	151.0	5.94	0.0	0.00
	PE-I <input checked="" type="checkbox"/> B <input checked="" type="checkbox"/> N	76.2	3.00					
		101.6	4.00					

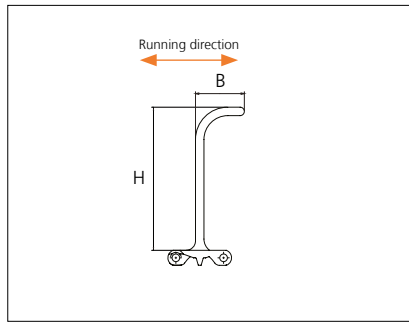

Type	Material & color	H		B		Link size	Width		Indent both sides	
		mm	in	mm	in		mm	in	mm	in
Bent	PP-I <span style="border: 1px solid black; padding: 2px;">W</span> <span style="background-color: #0056b3; color: white; padding: 2px;">B</span>	76.2	3.00	52.0	2.05	K600	151.0	5.94	0.0	0.00
	PP-I <span style="border: 1px solid black; padding: 2px;">W</span> <span style="background-color: #0056b3; color: white; padding: 2px;">B</span>	101.6	4.00							
	PE <span style="border: 1px solid black; padding: 2px;">N</span>									
	PP-I <span style="border: 1px solid black; padding: 2px;">W</span> <span style="background-color: #0056b3; color: white; padding: 2px;">B</span>	152.4	6.00							

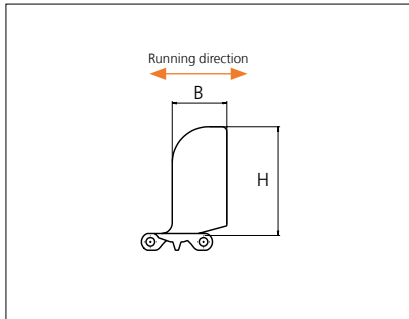

Type	Material & color	H		B		Link size	Width		Indent both sides	
		mm	in	mm	in		mm	in	mm	in
Cupped	PP-I <span style="border: 1px solid black; padding: 2px;">W</span>	76.2	3.00	52.0	2.05	K600	151.0	5.94	0.0	0.00
		101.6	4.00							
		152.4	6.00							

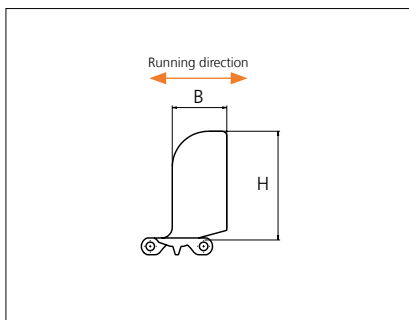

Type	Material & color	H		B		Link size	Width		Indent both sides	
		mm	in	mm	in		mm	in	mm	in
Cupped drain	PP-I <span style="border: 1px solid black; padding: 2px;">W</span>	76.2	3.00	52.0	2.05	K600	151.0	5.94	0.0	0.00
		101.6	4.00							
		152.4	6.00							

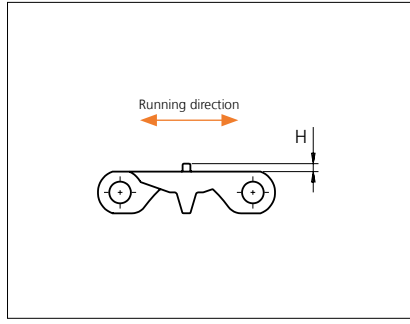
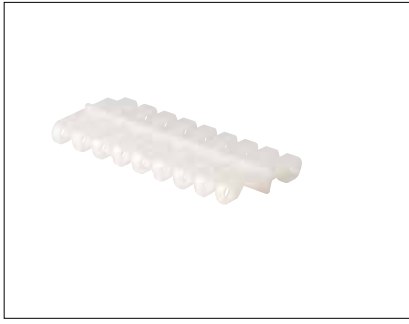

Type	Material & color	H		Link size	Width		Indent both sides	
		mm	in		mm	in	mm	in
Flat 20%	PE-I	5.0	0.20	K600	151.0	5.94	3.0	0.12

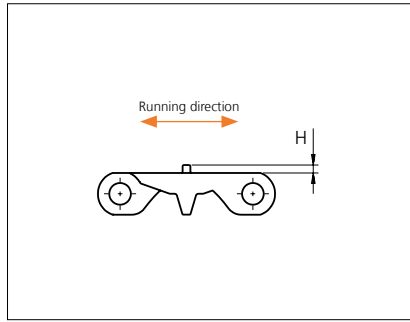
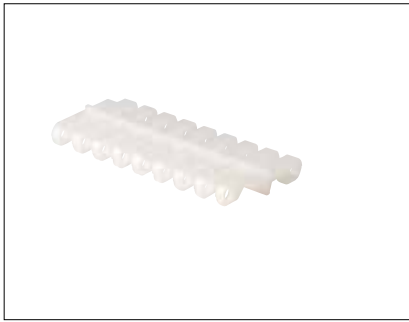

Type	Material & color	H		Link size	Width		Indent both sides	
		mm	in		mm	in	mm	in
Flat 22%	PE-I	3.0	0.12	K600	151.0	5.94	3.0	0.12

uni MPB flights/180216



Expert advice, quality solutions and local service for all your belting needs  
[www.ammeraalbeltech.com](http://www.ammeraalbeltech.com)

**Ammeraal Beltech Modular A/S**  
 Hjulmagervej 21  
 DK-7100 Vejle

T +45 7572 3100  
 F +45 7572 3348  
 admin@unichains.com  
 www.unichains.com

This information is subject to alteration due to continuous development. Ammeraal Beltech will not be held liable for the incorrect use of the above stated information. This information replaces previous information. All activities performed and services rendered by Ammeraal Beltech are subject to general terms and conditions of sale and delivery, as applied by its operating companies.



# Plastic Modular Belt

Series **uni MPB** Type **G**

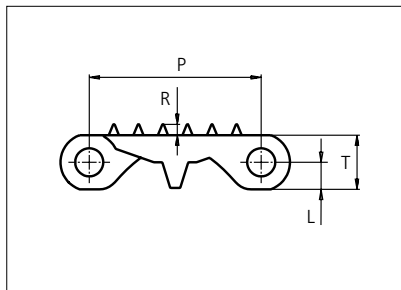
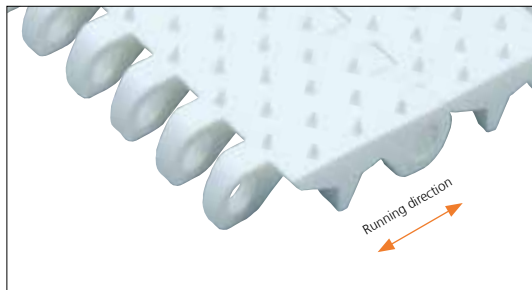

Straight running belt  
 Nominal pitch: 50.8 mm (2.00 in)  
 Surface type: Grip  
 Surface opening: Closed  
 Backflex radius: 65.0 mm (2.6 in)  
 Pin diameter: 8.0 mm (0.31 in)

Belt material & color	POM-DI <span style="border: 1px solid black; padding: 0 2px;">W</span>		mm	in		mm	in
		P (Nominal)	50.8	2.00	R	3.2	0.13
Pin material & color	PP <span style="border: 1px solid black; padding: 0 2px;">W</span>						
		L	8.0	0.31	T	16.0	0.63

Non standard material and color: See uni Material and Color Overview.

Alternative pin and lock materials: N Pin: PA6.6 W PP W PE W PBT LG SS304 B Lockpin: PA6.6 B PBT LG N Trilock: PA6.6 N

uni MPB G is available with a molded indent of 35.0 mm (1.38 in) in both sides.

Belt width		Permissible tensile force (Belt/pin material)		Belt weight (Belt/pin material)		*Min. No. drive sprocket per shaft	Number of wear strips (Min. No.)	
		POM-DI/PP		POM-DI/PP			**Carry (pcs)	**Return (pcs)
mm	in	N	lbf	kg/m	lb/ft			
151	5.9	4153	933	1.8	1.21	2	2	2
202	8.0	5555	1249	2.4	1.62	2	2	2
252	9.9	6930	1558	3.0	2.02	2	2	2
302	11.9	8305	1867	3.6	2.42	3	3	2
353	13.9	9708	2182	4.2	2.82	3	3	2
403	15.9	11083	2491	4.8	3.22	3	3	2
453	17.8	12458	2800	5.4	3.62	4	4	2
504	19.8	13860	3116	6.0	4.03	4	4	2
554	21.8	15235	3425	6.6	4.43	4	4	2
604	23.8	16610	3734	7.2	4.83	5	5	3
655	25.8	18013	4049	7.8	5.24	5	5	3
705	27.8	19388	4358	8.4	5.64	5	5	3
755	29.7	20763	4667	9.0	6.04	6	6	3

Additional standard belt widths are available in steps of 50.3 mm (1.98 in.) Additional non-standard belt widths are available in steps of 16.8 mm (0.66 in).

1963	77.3	53983	12135	23.4	15.70	14	14	7
------	------	-------	-------	------	-------	----	----	---

Additional standard belt widths are available in steps of 50.3 mm (1.98 in.) Additional non-standard belt widths are available in steps of 16.8 mm (0.66 in).

2970	116.9	81675	18361	35.3	23.75	20	20	10
------	-------	-------	-------	------	-------	----	----	----

General belt tolerance is +0/-0.4% at 23°C/73°F and 50% RH. For exact belt width contact Customer Service. Non standard belt width on request.

\*Max. Load per Drive Sprocket. Belt material: POM-DI with snub roller 2000 N (450 lbf) without snub roller 1250 N (281 lbf).

\*\*Max. Spacing between wear strips, Carry: 152.0 mm (6.00 in); Return: 304.0 mm (12.00 in).

  = Single Link



STANDARD

STRAIGHT RUNNING

PITCH 50.8 MM/2.00 IN

## Accessories

### Flight

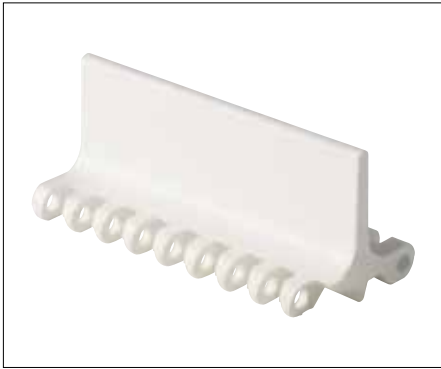

See separate uni MPB series Flight datasheet.

## Accessories

### Side Guard

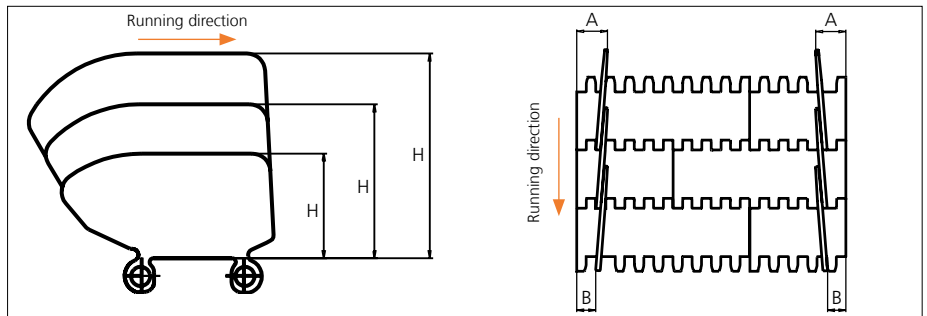

Type	Side Guard Material & color	H		A		B	
		mm	in	mm	in	mm	in
Closed	PE-I <span style="border: 1px solid black; padding: 2px;">B</span> <span style="border: 1px solid black; padding: 2px;">N</span>	50.8	2.00	32.0	1.26	16.0	0.63
	PP-I <span style="border: 1px solid black; padding: 2px;">W</span> <span style="border: 1px solid black; padding: 2px;">B</span>	76.2	3.00				
		101.6	4.00				

\*34.0 mm (1.34 in) combined with flight. Increment: 8.4 mm (0.33 in).

Backflex radius when Side Guard are used: 200.0 mm (7.90 in).

## Accessories

### Tab

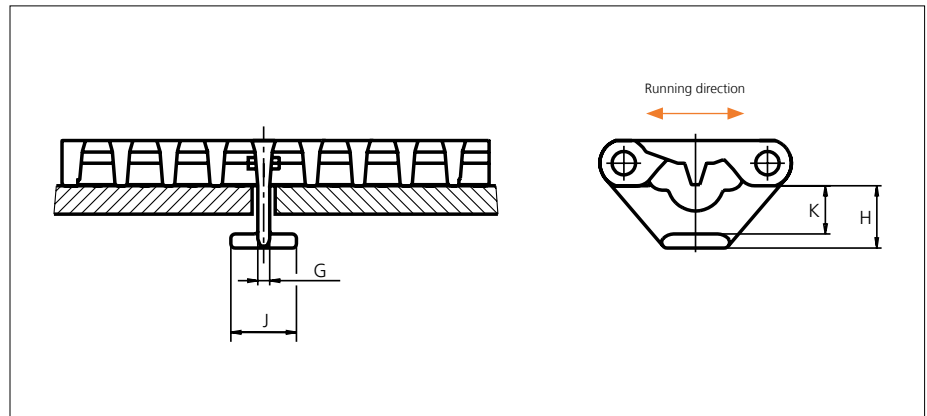

Type	Tab Material & color	G		J		K		H	
		mm	in	mm	in	mm	in	mm	in
Bottom Hold Down	POM-DI <span style="border: 1px solid black; padding: 2px;">W</span>	4.2	0.17	23.2	0.91	17.0	0.67	22.0	0.87

Note: When using taps, please verify sufficient clearance to the shaft. Max. shaft diameter = Sprocket pitch diameter - 63.5 mm (2.50 in). When using square shafts, please verify that the diagonal does not exceed max. diameter. Example: Sprocket z = 6: Max. shaft diameter 101.6 - 63.5 =  $\varnothing$ 38.1 mm (4.00 - 2.50 =  $\varnothing$ 1.4 in).

Note: When using a belt system with tabs, the temperature should be constant. Please note that the tabs are not always placed in the middle of the belt.

Non Standard material and color: See uni Material and Color Overview.



## Sprocket

No of teeth	Bore size										Overall diameter		Pitch-diameter		Hub-diameter		Dimension A		Dimension B		Single row/One way	Double row/Two way	Molded PA6 LG	Machined PA6 N					
	Pilot bore	1.00			1.18			1.25																	1.50			1.57	
	mm	25.4	30.0	31.8	38.1	40.0	60.0	63.5	90.0	mm	in	mm	in	mm	in	mm	in	mm	in	mm					in	mm	in	mm	in
Z06	✓	●	●	●	■	●	■			99.5	3.92	101.6	4.00	65.0	2.56	36.0	1.42	59.3	2.33	✓		✓							
Z08	✓	●	●	●	■	●	■	■		132.9	5.23	132.8	5.23	70.0	2.75	53.3	2.10	74.9	2.94	✓	1✓	✓							
Z10	✓		1●	1●	1●	1●	1■	2■	2■	166.3	6.55	164.4	6.47	<sup>1</sup> 70.0 <sup>2</sup> 120.0	2.75 4.72	70.2	2.76	90.7	3.57	✓	✓	✓							
Z12	✓		1●	1●	1●	1●	1■	2■	2■	198.6	7.82	196.3	7.73	<sup>1</sup> 70.0 <sup>2</sup> 120.0 <sup>3</sup> 164.0	2.75 4.72 6.45	86.8 86.8	3.42 3.42	106.6 106.6	4.19 4.19	<sup>1+2</sup> ✓	<sup>2+3</sup> ✓	✓							
Z16	✓		2● 1●	2● 1●	2●	2■	2■	3■	2■	263.8	10.39	260.4	10.25	<sup>1</sup> 150.0 <sup>2</sup> 164.0 <sup>3</sup> 200.0	5.90 6.45 7.87	119.7	4.71	138.7	5.46	<sup>1</sup> ✓	<sup>2+3</sup> ✓	✓	✓						

● Molded sprocket    ■ Molded sprocket    ■ Machined sprocket



Other sprocket sizes are available upon request.  
 Other bore sizes on sprockets are available upon request.  
 Round bores are always delivered with keyway.  
 Max. load per sprocket shown does not take bore size into account.  
 Please also ensure that sufficient size shaft is chosen for corresponding load.  
 Width of tooth = Single row: 9.5 mm (0.37 in)  
 = Double row: 17.8 mm (0.70 in)  
 Width of One-part sprocket = Single row: 42.3 mm (1.66 in)  
 = Double row: 42.3 mm (1.66 in)  
 = <sup>3</sup>Double row: 50.0 mm (1.96 in)

## uni UltraClean Two-Part Sprocket

No. of teeth	Bore size				Overall diameter		Pitch-diameter		Hub-diameter		Dimension A		Dimension B		Single row/One way	Moulded PA6 W
	in	1.50	1.57	2.36												
	mm	38.1	40.0	60.0	mm	in	mm	in	mm	in	mm	in	mm	in		
Z8		■	■		132.9	5.23	132.8	5.23	80.0	3.15	53.3	2.10	74.9	2.94	✓	✓
Z10		1■	1■	2■	166.3	6.55	164.4	6.47	<sup>1</sup> 126.0 <sup>2</sup> 118.0	<sup>1</sup> 4.96 <sup>2</sup> 4.65	70.2	2.76	90.7	3.57	✓	✓
Z12		1■	1■	2■	198.6	7.82	196.3	7.73	<sup>1</sup> 126.0 <sup>2</sup> 118.0	<sup>1</sup> 4.96 <sup>2</sup> 4.65	86.8	3.42	106.6	4.19	✓	✓

■ Moulded uni UltraClean TwoPart Sprocket

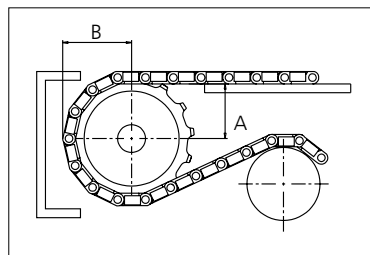

Width of UltraClean Two-part sprocket = Single row: 44.0 mm (1.73 in)  
 Width of UltraClean Two-part sprocket, tooth = Single row: 9.5 mm (0.37 in)

uni Retainer Rings: See uni Retainer Ring data sheet.  
 For correct sprocket position: See uni Assembly Instructions for uni MPB.  
 For more detailed sprocket information, contact Customer Service.



Conveyor Belts



Seamless Belts



Modular Belts



Timing Belts



Transmission Belts



Fabrication & service

Expert advice, quality solutions and local service for all your belting needs [www.ammeraalbeltech.com](http://www.ammeraalbeltech.com)

**Ammeraal Beltech Modular A/S**  
Hjulgagervej 21  
DK-7100 Vejle

T +45 7572 3100  
F +45 7572 3348  
admin@unichains.com  
www.unichains.com

This information is subject to alteration due to continuous development. Ammeraal Beltech will not be held liable for the incorrect use of the above stated information. This information replaces previous information. All activities performed and services rendered by Ammeraal Beltech are subject to general terms and conditions of sale and delivery, as applied by its operating companies.



# Plastic Modular Belt

Series **uni MPB** Type **N**

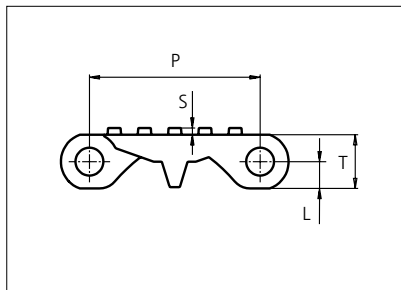
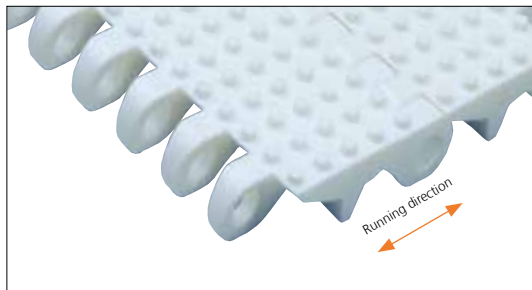

Straight running belt  
 Nominal pitch: 50.8 mm (2.00 in)  
 Surface type: No Cling  
 Surface opening: Closed  
 Backflex radius: 65.0 mm (2.6 in)  
 Pin diameter: 8.0 mm (0.31 in)

Belt material & color	PE-I	mm	in	mm	in		
	P (Nominal)					50.8	2.00
Pin material & color	PE	L	8.0	0.31	T	16.0	0.63

Non standard material and color: See uni Material and Color Overview.

Alternative pin and lock materials: Pin: PA6.6 PP PE PBT SS304 Lockpin: PA6.6 PBT Trilock: PA6.6

uni MPB N is available with a molded indent of 35.0 mm (1.38 in) in both sides.

Belt width		Permissible tensile force (Belt/pin material)		Belt weight (Belt/pin material)		*Min. No. drive sprocket per shaft	Number of wear strips (Min. No.)	
		PE-I/PE		PE-I/PE			**Carry (pcs)	**Return (pcs)
mm	in	N	lbf	kg/m	lb/ft			
151	5.9	1963	441	1.3	0.89	2	2	2
202	8.0	2626	590	1.8	1.19	2	2	2
252	9.9	3276	736	2.2	1.49	2	2	2
302	11.9	3926	883	2.7	1.79	3	3	2
353	13.9	4589	1032	3.1	2.09	3	3	2
403	15.9	5239	1178	3.5	2.38	3	3	2
453	17.8	5889	1324	4.0	2.68	4	4	2
504	19.8	6552	1473	4.4	2.98	4	4	2
554	21.8	7202	1619	4.9	3.28	4	4	2
604	23.8	7852	1765	5.3	3.57	5	5	3
655	25.8	8515	1914	5.8	3.87	5	5	3
705	27.8	9165	2060	6.2	4.17	5	5	3
755	29.7	9815	2206	6.6	4.47	6	6	3

Additional standard belt widths are available in steps of 50.3 mm (1.98 in.) Additional non-standard belt widths are available in steps of 16.8 mm (0.66 in).

1963	77.3	25519	5737	17.3	11.61	14	14	7
------	------	-------	------	------	-------	----	----	---

Additional standard belt widths are available in steps of 50.3 mm (1.98 in.) Additional non-standard belt widths are available in steps of 16.8 mm (0.66 in).

2970	116.9	38610	8680	26.1	17.56	20	20	10
------	-------	-------	------	------	-------	----	----	----

General belt tolerance is +0/-0.4% at 23°C/73°F and 50% RH. For exact belt width contact Customer Service. Non standard belt width on request.

\*Max. Load per Drive Sprocket. Belt material: POM-DI with snub roller 2000 N (450 lbf) without snub roller 1250 N (281 lbf).

\*\*Max. Spacing between wear strips, Carry: 152.0 mm (6.00 in); Return: 304.0 mm (12.00 in).

= Single Link



STANDARD

STRAIGHT RUNNING

PITCH 50.8 MM/2.00 IN

## Accessories

### Flight

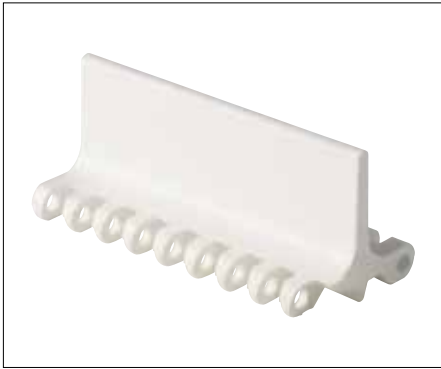

See separate uni MPB series Flight datasheet.

## Accessories

### Side Guard

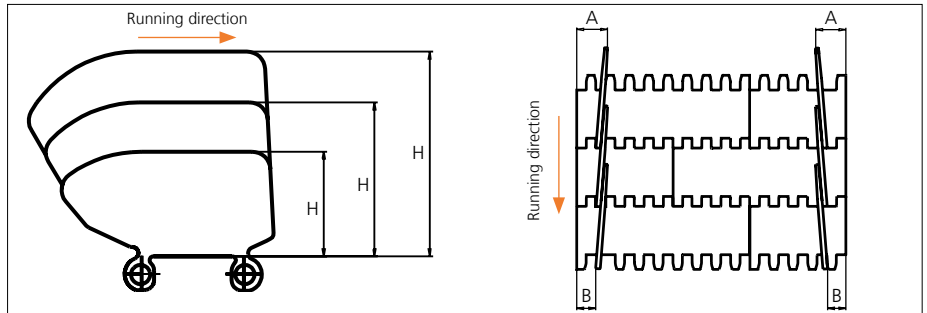

Type	Side Guard Material & color	H		A		B	
		mm	in	mm	in	mm	in
Closed	PE-I <span style="border: 1px solid black; padding: 2px;">B</span> <span style="border: 1px solid black; padding: 2px;">N</span>	50.8	2.00	32.0	1.26	16.0	0.63
	PP-I <span style="border: 1px solid black; padding: 2px;">W</span> <span style="border: 1px solid black; padding: 2px;">B</span>	76.2	3.00				
		101.6	4.00				

\*34.0 mm (1.34 in) combined with flight. Increment: 8.4 mm (0.33 in).

Note: Backflex radius when Side Guard are used: 200.0 mm (7.90 in).

## Accessories

### Tab

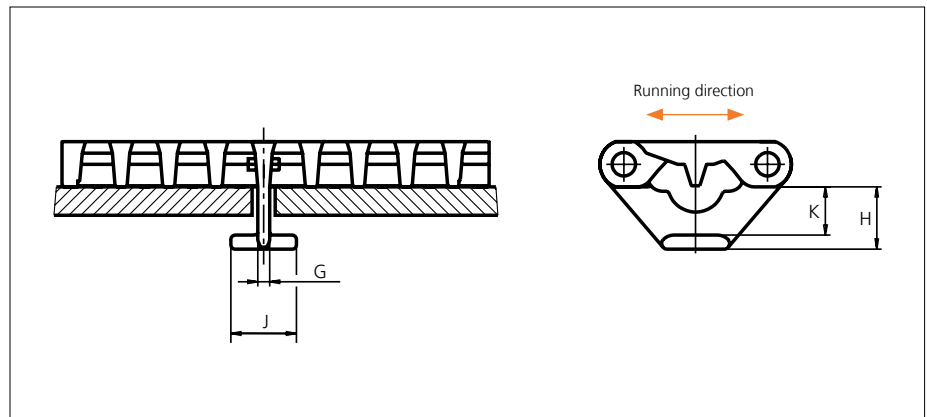

Type	Tab Material & color	G		J		K		H	
		mm	in	mm	in	mm	in	mm	in
Bottom Hold Down	POM-DI <span style="border: 1px solid black; padding: 2px;">W</span>	4.2	0.17	23.2	0.91	17.0	0.67	22.0	0.87

Note: When using taps, please verify sufficient clearance to the shaft. Max. shaft diameter = Sprocket pitch diameter - 63.5 mm (2.50 in). When using square shafts, please verify that the diagonal does not exceed max. diameter. Example: Sprocket z = 6: Max. shaft diameter 101.6 - 63.5 =  $\varnothing$ 38.1 mm (4.00 - 2.50 =  $\varnothing$ 1.4 in).

Note: When using a belt system with tabs, the temperature should be constant. Please note that the tabs are not always placed in the middle of the belt.

Non Standard material and color: See uni Material and Color Overview.

## Sprocket

No of teeth	Bore size									Overall diameter		Pitch-diameter		Hub-diameter		Dimension A		Dimension B		Single row/One way	Double row/Two way	Molded PA6 LG	Machined PA6 N
	Pilot bore	1.00			1.18			1.25															
	mm	25.4	30.0	31.8	38.1	40.0	60.0	63.5	90.0	mm	in	mm	in	mm	in	mm	in	mm	in				
Z06	✓	●	●	●	■	●	■			99.5	3.92	101.6	4.00	65.0	2.56	36.0	1.42	59.3	2.33	✓		✓	
Z08	✓	●	●	●	■	●	■	■		132.9	5.23	132.8	5.23	70.0	2.75	53.3	2.10	74.9	2.94	✓	✓ <sup>1</sup>	✓	
Z10	✓		1●	1●	1●	1●	1●	2■	2■	166.3	6.55	164.4	6.47	<sup>1</sup> 70.0 <sup>2</sup> 120.0	2.75 4.72	70.2	2.76	90.7	3.57	✓	✓	✓	
Z12	✓		1●	1●	1●	1●	1●	2■	2■	198.6	7.82	196.3	7.73	<sup>1</sup> 70.0 <sup>2</sup> 120.0 <sup>3</sup> 164.0	2.75 4.72 6.45	86.8 86.8	3.42 3.42	106.6 106.6	4.19 4.19	1+2✓	2+3✓	✓	
Z16	✓		2● 1●	2● 1●	2● 1●	2● 1●	2● 1●	3■ 1■	2■ 1■	263.8	10.39	260.4	10.25	<sup>1</sup> 150.0 <sup>2</sup> 164.0 <sup>3</sup> 200.0	5.90 6.45 7.87	119.7	4.71	138.7	5.46	1✓	2+3✓	✓	✓

● Molded sprocket    ■ Molded sprocket    ■ Machined sprocket



Other sprocket sizes are available upon request.  
 Other bore sizes on sprockets are available upon request.  
 Round bores are always delivered with keyway.  
 Max. load per sprocket shown does not take bore size into account.  
 Please also ensure that sufficient size shaft is chosen for corresponding load.  
 Width of tooth = Single row: 9.5 mm (0.37 in)  
 = Double row: 17.8 mm (0.70 in)  
 Width of One-part sprocket = Single row: 42.3 mm (1.66 in)  
 = Double row: 42.3 mm (1.66 in)  
 = <sup>3</sup>Double row: 50.0 mm (1.96 in)

## uni UltraClean Two-Part Sprocket

No. of teeth	Bore size				Overall diameter		Pitch-diameter		Hub-diameter		Dimension A		Dimension B		Single row/One way	Moulded PA6 W
	in	1.50	1.57	2.36												
	mm	38.1	40.0	60.0	mm	in	mm	in	mm	in	mm	in	mm	in		
Z8		■	■		132.9	5.23	132.8	5.23	80.0	3.15	53.3	2.10	74.9	2.94	✓	✓
Z10		1■	1■	2■	166.3	6.55	164.4	6.47	<sup>1</sup> 126.0 <sup>2</sup> 118.0	<sup>1</sup> 4.96 <sup>2</sup> 4.65	70.2	2.76	90.7	3.57	✓	✓
Z12		1■	1■	2■	198.6	7.82	196.3	7.73	<sup>1</sup> 126.0 <sup>2</sup> 118.0	<sup>1</sup> 4.96 <sup>2</sup> 4.65	86.8	3.42	106.6	4.19	✓	✓

■ Moulded uni UltraClean TwoPart Sprocket

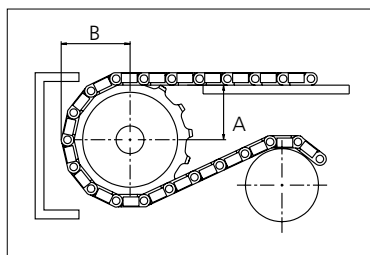

Width of UltraClean Two-part sprocket = Single row: 44.0 mm (1.73 in)  
 Width of UltraClean Two-part sprocket, tooth = Single row: 9.5 mm (0.37 in)

uni Retainer Rings: See uni Retainer Ring data sheet.  
 For correct sprocket position: See uni Assembly Instructions for uni MPB.  
 For more detailed sprocket information, contact Customer Service.



Conveyor Belts



Seamless Belts



Modular Belts



Timing Belts



Transmission Belts



Fabrication & service

Expert advice, quality solutions and local service for all your belting needs  
[www.ammeraalbeltech.com](http://www.ammeraalbeltech.com)

**Ammeraal Beltech Modular A/S**  
Hjulmagervej 21  
DK-7100 Vejle

T +45 7572 3100  
F +45 7572 3348  
admin@unichains.com  
www.unichains.com

This information is subject to alteration due to continuous development. Ammeraal Beltech will not be held liable for the incorrect use of the above stated information. This information replaces previous information. All activities performed and services rendered by Ammeraal Beltech are subject to general terms and conditions of sale and delivery, as applied by its operating companies.



# Plastic Modular Belt

Series **uni MPB** Type **RO**

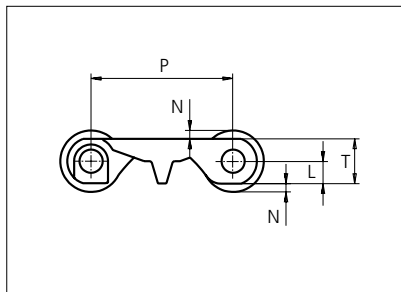
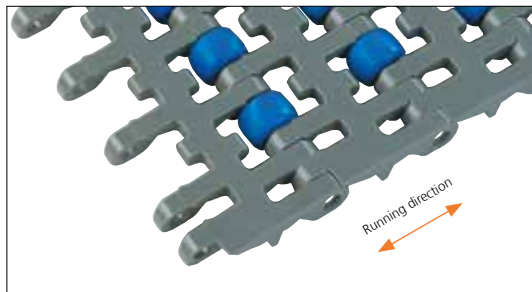

Straight running belt  
 Nominal pitch: 50.8 mm (2.00 in)  
 Surface type: Roller Top  
 Surface opening: 22%  
 Backflex radius: 65.0 mm (2.6 in)  
 Pin diameter: 8.0 mm (0.31 in)

<b>Recommended belt material &amp; color</b>	POM-DI <b>G</b>		<b>mm</b>	<b>in</b>		<b>mm</b>	<b>in</b>
<b>Recommended pin material &amp; color</b>	PP <b>W</b>	<b>P (Nominal)</b>	50.8	2.00	<b>L</b>	8.0	0.31
		<b>N</b>	3.0	0.12	<b>T</b>	16.0	0.63

Non standard material and color: See uni Material and Color Overview.

Alternative pin and lock materials: Pin: PA6.6 **N** PP **W** PE **W** PBT **LG** SS304 Lockpin: PA6.6 **B** PBT **LG** Trilock: PA6.6 **N**

Belt width		Permissible tensile force (Belt/pin material)		Belt weight (Belt/pin material)		*Min. No. drive sprocket per shaft	Number of wear strips (Min. No.)	
		POM-DI/PP		POM-DI/PP			**Carry (pcs)	**Return (pcs)
mm	in	N	lbf	kg/m	lb/ft			
151	5.9	1661	373	1.7	1.15	2	2	2
185	7.3	2030	456	2.1	1.40	2	2	2
202	8.0	2222	500	2.3	1.53	2	2	2
252	9.9	2772	623	2.8	1.91	2	2	2
302	11.9	3322	747	3.4	2.29	3	3	2
353	13.9	3883	873	4.0	2.68	3	3	2
403	15.9	4433	997	4.6	3.06	3	3	2
453	17.8	4983	1120	5.1	3.44	4	4	2
504	19.8	5544	1246	5.7	3.83	4	4	2
554	21.8	6094	1370	6.3	4.21	4	4	2
604	23.8	6644	1494	6.8	4.59	5	5	3
655	25.8	7205	1620	7.4	4.97	5	5	3
705	27.8	7755	1743	8.0	5.35	5	5	3

Additional standard belt widths are available in steps of 50.3 mm (1.98 in). Additional non-standard belt widths are available in steps of 16.8 mm (0.66 in).

1963	77.3	21593	4854	22.2	14.91	14	14	7
------	------	-------	------	------	-------	----	----	---

Additional standard belt widths are available in steps of 50.3 mm (1.98 in). Additional non-standard belt widths are available in steps of 16.8 mm (0.66 in).

2970	116.9	32670	7344	33.6	22.55	20	20	10
------	-------	-------	------	------	-------	----	----	----

General belt tolerance is +0/-0.4% at 23°C/73°F and 50% RH. For exact belt width contact Customer Service. Non standard belt width on request.

\*Max. Load per Drive Sprocket. Belt material: PP with snub roller 2000 N (450 lbf) without snub roller 1250 N (281 lbf).

\*\*Max. Spacing between wear strips, Carry: 152.0 mm (6.00 in); Return: 304.0 mm (12.00 in).

= Single Link



NON STANDARD

STRAIGHT RUNNING

PITCH 50.8 MM/2.00 IN

## Sprocket

No of teeth	Bore size										Overall diameter		Pitch-diameter		Hub-diameter		Dimension A		Dimension B		Single row/One way	Double row/Two way	Molded	Machined	
	Pilot bore		1.00		1.18		1.25		1.50																1.57
	mm	in	25.4	30.0	31.8	38.1	40.0	60.0	63.5	90.0	mm	in	mm	in	mm	in	mm	in	mm	in					
Z06	✓	●	●	●	■	●	■					99.5	3.92	101.6	4.00	65.0	2.56	36.0	1.42	59.3	2.33	✓	✓		
Z08	✓	●	●	●	■	●	■					132.9	5.23	132.8	5.23	70.0	2.75	53.3	2.10	74.9	2.94	✓	✓ <sup>1</sup>	✓	
Z10	✓		●	●	●	■	■	■	■	■	■	166.3	6.55	164.4	6.47	<sup>1</sup> 70.0 <sup>2</sup> 120.0	2.75 4.72	70.2	2.76	90.7	3.57	✓	✓	✓	
Z12	✓		●	●	●	■	■	■	■	■	■	198.6	7.82	196.3	7.73	<sup>1</sup> 70.0 <sup>2</sup> 120.0 <sup>3</sup> 164.0	2.75 4.72 6.45	86.8 86.8	3.42 3.42	106.6 106.6	4.19 4.19	✓ <sup>1+2</sup>	✓ <sup>2+3</sup>	✓	
Z16	✓		●	●	●	■	■	■	■	■	■	263.8	10.39	260.4	10.25	<sup>1</sup> 150.0 <sup>2</sup> 164.0 <sup>3</sup> 200.0	5.90 6.45 7.87	119.7	4.71	138.7	5.46	✓ <sup>1</sup>	✓ <sup>2+3</sup>	✓	✓

● Molded sprocket    ■ Molded sprocket    ■ Machined sprocket



Other sprocket sizes are available upon request.  
 Other bore sizes on sprockets are available upon request.  
 Round bores are always delivered with keyway.  
 Max. load per sprocket shown does not take bore size into account.  
 Please also ensure that sufficient size shaft is chosen for corresponding load.  
 Width of tooth = Single row: 9.5 mm (0.37 in)  
 = Double row: 17.8 mm (0.70 in)  
 Width of One-part sprocket = Single row: 42.3 mm (1.66 in)  
 = Double row: 42.3 mm (1.66 in)  
 = <sup>3</sup>Double row: 50.0 mm (1.96 in)

## uni UltraClean Two-Part Sprocket

No. of teeth	Bore size				Overall diameter		Pitch-diameter		Hub-diameter		Dimension A		Dimension B		Single row/One way	Moulded
	in		1.50													
	mm	in	38.1	40.0	60.0	mm	in	mm	in	mm	in	mm	in			
Z8		■	■		132.9	5.23	132.8	5.23	80.0	3.15	53.3	2.10	74.9	2.94	✓	✓
Z10		■	■	■	166.3	6.55	164.4	6.47	<sup>1</sup> 126.0 <sup>2</sup> 118.0	<sup>1</sup> 4.96 <sup>2</sup> 4.65	70.2	2.76	90.7	3.57	✓	✓
Z12		■	■	■	198.6	7.82	196.3	7.73	<sup>1</sup> 126.0 <sup>2</sup> 118.0	<sup>1</sup> 4.96 <sup>2</sup> 4.65	86.8	3.42	106.6	4.19	✓	✓

### ■ Moulded uni UltraClean TwoPart Sprocket

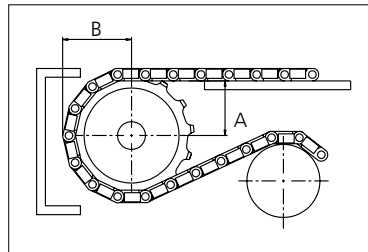

Width of UltraClean Two-part sprocket = Single row: 44.0 mm (1.73 in)  
 Width of UltraClean Two-part sprocket, tooth = Single row: 9.5 mm (0.37 in)

uni Retainer Rings: See uni Retainer Ring data sheet.  
 For correct sprocket position: See uni Assembly Instructions for uni MPB.  
 For more detailed sprocket information, contact Customer Service.



Expert advice, quality solutions and local service for all your belting needs  
[www.ammeraalbeltech.com](http://www.ammeraalbeltech.com)

**Ammeraal Beltech Modular A/S**  
 Hjulmagervej 21  
 DK-7100 Vejle

T +45 7572 3100  
 F +45 7572 3348  
 admin@unichains.com  
 www.unichains.com

This information is subject to alteration due to continuous development. Ammeraal Beltech will not be held liable for the incorrect use of the above stated information. This information replaces previous information. All activities performed and services rendered by Ammeraal Beltech are subject to general terms and conditions of sale and delivery, as applied by its operating companies.





# Plastic Modular Belt

Serie **uni NTB** Type **C**

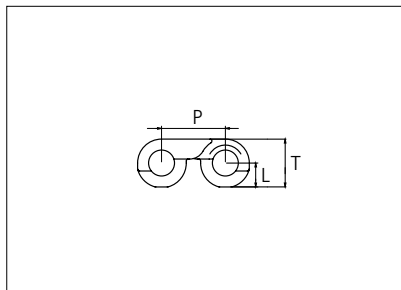

Straight Running Belt  
 Nominal pitch: 8.0 mm (0.32 in)  
 Surface type: Flat  
 Surface opening: Closed  
 Backflex radius: R6 mm (0.24 in)  
 Pin diameter: 3.0 mm (0.12 in)

<b>Belt material &amp; color</b>	POM-D <b>B</b>		<b>mm</b>	<b>in</b>		<b>mm</b>	<b>in</b>
<b>Pin material &amp; color</b>	PA6.6 <b>B</b>	<b>P (Nominal)</b>	8.0	0.32	<b>T</b>	6.00	0.24
		<b>L</b>	3.00	0.12	-	-	-

Non standard material and color: See uni Material and Color Overview.

Alternative pin and lock materials: PBT **LG**

Belt width		Permissible tensile force (Belt/pin material)		Belt weight (Belt/pin material)		*Min No drive sprocket per shaft	Number of wear strips (min no)	
		POM-D/PA6.6		POM-D/PA6.6			**Carry (pcs)	**Return (pcs)
mm	in	N	lbf	Kg/m	lb/ft			
76	3.0	167	38	0.4	0.24	2	2	2
153	6.0	337	76	0.7	0.49	2	2	2
229	9.0	504	113	1.1	0.73	3	3	2
305	12.0	671	151	1.5	0.98	4	4	2
381	15.0	838	188	1.8	1.22	4	4	2
458	18.0	1008	227	2.2	1.47	5	5	3
534	21.0	1175	264	2.5	1.71	6	6	3
610	24.0	1342	302	2.9	1.95	7	7	4
686	27.0	1509	339	3.3	2.19	7	7	4
762	30.0	1676	377	3.6	2.44	8	8	4
839	33.0	1846	415	4.0	2.68	9	9	5
915	36.0	2013	453	4.4	2.93	10	10	5
991	39.0	2180	490	4.7	3.17	10	10	5

Additional standard belt widths are available in steps of 76.2 mm (3.00 in). Additional non-standard belt widths are available in steps of 25.4 mm (1.00 in).

1448	57.0	3186	716	6.9	4.63	15	15	8
------	------	------	-----	-----	------	----	----	---

Additional standard belt widths are available in steps of 76.2 mm (3.00 in). Additional non-standard belt widths are available in steps of 25.4 mm (1.00 in).

1982	78.0	4360	980	9.4	6.34	20	20	10
------	------	------	-----	-----	------	----	----	----

General belt tolerance is +0/-0.4% at 23°C/73°F and 50% RH. For exact belt width contact Customer Service. Non standard belt width on request.

\*Max. Load per Drive Sprocket. Belt material: POM-D 200N (44 lbf).

\*\*Max. Spacing between wear strips, Carry: 102.0 mm (4.00 in); Return: 203.0 mm (8.00 in).

= Single Link



STANDARD

STRAIGHT RUNNING

PITCH 8.0 MM/0.32 IN

## Sprocket

No. of teeth	Bore size										Overall diameter		Pitch diameter		Hub diameter		Dimension A		Dimension B		Single row/Two way	Double row/Two way	Molded PA6 LG	Machined PA6 N
	Pilot bore	in	0.75	0.78	0.98	1.00	1.18	1.25	1.50	1.57														
	mm	19.1	20.0	25.0	25.4	30.0	31.8	38.1	40.0	mm	in	mm	in	mm	in	mm	in							
<b>Z24</b>	x		●		●						61.3	2.41	61.3	2.41	57.3	2.26	27.38	1.08	33.65	1.32		x		x
<b>Z32</b>	x		●							■	81.6	3.21	81.7	3.21	77.6	3.06	37.61	1-48	43.8	1.72		x		x
<b>Z48</b>	x		●							■	122.7	4.83	122.4	4.81	118.7	4.67	58.03	2.28	64.16	2.52		x		x
<b>Z60</b>	x		●							■	152.9	6.02	152.9	6.02	148.9	5.86	73.32	2.88	79.43	3.13		x		x

■ Machined sprocket ● Machined sprocket

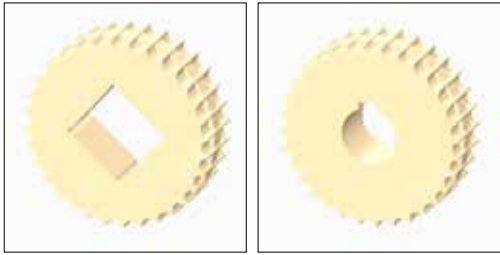

Non standard material and color: See uni Material and Color Overview.

### Nosebars Min. Dimensions

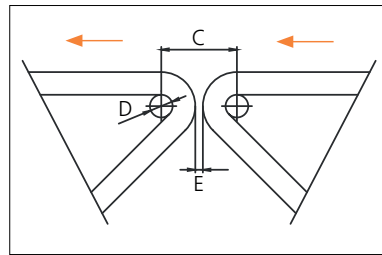
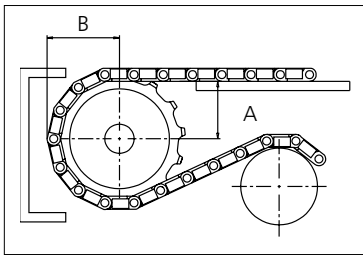

	mm	in
<b>C</b>	20.0	0.79
<b>D</b>	6.0	0.24
<b>E</b>	2.0	0.08

Other sprocket sizes are available upon request.  
 Round bores are always delivered with keyway.  
 Other bore sizes are available upon request.  
 uni Retainer Rings: See uni Retainer Ring data sheet.  
 Width of tooth = 9.0 mm (0.35 in)  
 Width of sprocket = 25.0 mm (0.98 in)

Max load per sprocket shown does not take bore size into account.  
 Please also ensure that sufficient size shaft is chosen for corresponding load.

For correct sprocket position: See uni Assembly Instructions for uni NTB.  
 For more detailed sprocket information, contact Customer Service.

uni NTB C/170522



Expert advice, quality solutions and local service for all your belting needs  
[www.ammeraalbeltech.com](http://www.ammeraalbeltech.com)

**Ammeraal Beltech Modular A/S**  
 Hjulmagervej 21  
 DK-7100 Vejle

T +45 7572 3100  
 F +45 7572 3348  
 admin@unichains.com  
 www.unichains.com

This information is subject to alteration due to continuous development. Ammeraal Beltech will not be held liable for the incorrect use of the above stated information. This information replaces previous information. All activities performed and services rendered by Ammeraal Beltech are subject to general terms and conditions of sale and delivery, as applied by its operating companies.



# Plastic Modular Belt

Series **uni OPB 4** Type **C**

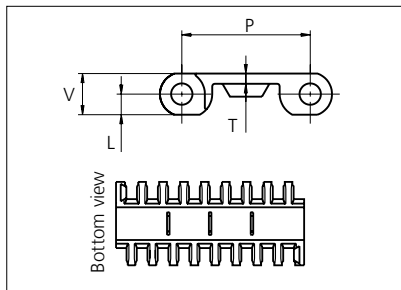

Straight running belt  
 Nominal pitch: 50.0 mm (1.97 in)  
 Surface type: Flat  
 Surface opening: Closed  
 Backflex radius: 75.0 mm (3.00 in)  
 Pin diameter: 8 mm (1.97 in)

\*uni-chains recommends this travel direction. However, travel in both directions is possible.

Recommended belt material & color	POM-D <b>W</b>		mm	in		mm	in
		<b>P (Nominal)</b>	50.0	1.97	<b>V</b>	16.0	0.63
Recommended pin and lock material & color	PP <b>W</b>						
		<b>L</b>	8.0	0.31	<b>T</b>	4.0	0.16

Non standard material and color: See uni Material and Color Overview.

Alternative materials: Belt: POM-LF, POM-SLF, PP, PE, PA6.6 and PA6.6H

Rodlock: PP **W**

Endlock: PP **W** **G** **B** and PE **W** **B**

Lockpin: PE **W** PA6.6 **N** PP **W**

Pin: PP **W** PE **W** SS304 and SS316

Belt width		Permissible tensile force (Belt/pin material)						Belt weight (Belt/pin material)						*Min. No. drive sprocket per shaft	Number of wear strips (Min. No.)	
		POM-D/PA6.6		PP/PA6.6		PE/PA6.6		POM-D/PA6.6		PP/PA6.6		PE/PA6.6			**Carry (pcs)	**Return (pcs)
mm	in	N	lbf	N	lbf	N	lbf	kg/m	lb/ft	kg/m	lb/ft	kg/m	lb/ft			
118	4.6	1298	292	649	146	389	88	1.4	0.93	0.9	0.59	1.0	0.64	2	2	2
151	5.9	1661	373	831	187	498	112	1.8	1.19	1.1	0.76	1.2	0.82	2	2	2
185	7.3	2035	457	1018	229	611	137	2.2	1.45	1.4	0.93	1.5	1.01	2	2	2
302	11.9	3322	747	1661	373	997	224	3.5	2.37	2.3	1.52	2.4	1.64	3	3	2
453	17.8	4983	1120	2492	560	1495	336	5.3	3.56	3.4	2.28	3.7	2.47	4	4	2
604	23.8	6644	1494	3322	747	1993	448	7.1	4.75	4.5	3.04	4.9	3.29	5	5	3
755	29.7	8305	1867	4153	933	2492	560	8.8	5.94	5.7	3.81	6.1	4.11	6	6	3
906	35.7	9966	2240	4983	1120	2990	672	10.6	7.12	6.8	4.57	7.3	4.93	7	7	4
1057	41.6	11627	2614	5814	1307	3488	784	12.4	8.31	7.9	5.33	8.6	5.75	8	8	4
1208	47.6	13288	2987	6644	1494	3986	896	14.1	9.50	9.1	6.09	9.8	6.58	9	9	5
1359	53.5	14949	3361	7475	1680	4485	1008	15.9	10.69	10.2	6.85	11.0	7.40	10	10	5
1510	59.4	16610	3734	8305	1867	4983	1120	17.7	11.87	11.3	7.61	12.2	8.22	11	11	6
1661	65.4	18271	4107	9136	2054	5481	1232	19.4	13.06	12.5	8.37	13.5	9.04	12	12	6

Additional standard belt widths are available in steps of 151.0 mm (5.94 in). Additional non-standard belt widths are available in steps of 33.6 mm (1.32 in)

2567	101.1	28237	6348	14119	3174	8471	1904	30.0	20.18	19.3	12.94	20.8	13.97	18	18	9
------	-------	-------	------	-------	------	------	------	------	-------	------	-------	------	-------	----	----	---

Additional standard belt widths are available in steps of 151.0 mm (5.94 in). Additional non-standard belt widths are available in steps of 33.6 mm (1.32 in)

2869	113.0	31559	7094	15780	3547	9468	2128	33.6	22.56	21.5	14.46	23.2	15.62	20	20	10
------	-------	-------	------	-------	------	------	------	------	-------	------	-------	------	-------	----	----	----

General belt tolerance is +0/-0.4% at 23°C/73°F and 50% RH. For exact belt width contact Customer Service. Non standard belt width on request.

\*Max. Load per Drive Sprocket. Belt material: POM 2500 N (562 lbf), PP 1200 N (270 lbf), PE 500 N (270 lbf)

\*\*Max. Spacing between wear strips, Carry: 152 mm (6 in); Return: 304 mm (12 in)

= Single Link



NON STANDARD

STRAIGHT RUNNING

PITCH 50.0 MM/1.97 IN

## Accessories

### Rubber Top

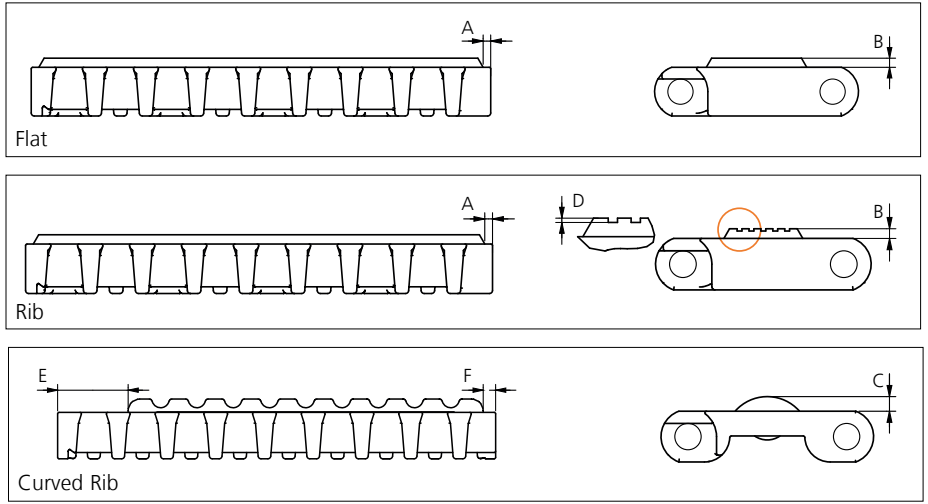

Type	Belt Material & color	Rubber Material & color	A		B		C		D		E		F		Link size	Width	
			mm	in	mm	in	mm	in	mm	in	mm	in	mm	in		mm	in
Flat	POM-LF <b>BR</b>	03 <b>N</b>															
Rib	POM-D <b>W</b>		2.5	0.10	3.0	0.12	4.5	0.18	0.7	0.03	24.0	0.94	4.0	0.16	K600	150.5	5.93
Curved Rib	POM-D <b>W</b>	03 <b>K</b>															

Other Non Standard Rubber profiles: See uni Rubber Profile Overview.

## Accessories

### Flight

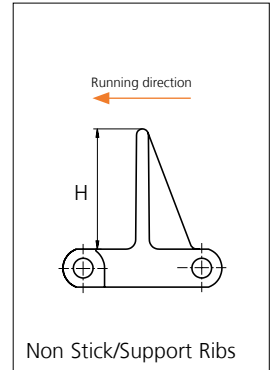
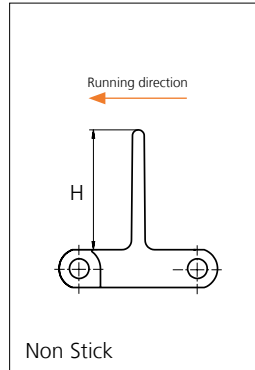

Type	Recommended Material & color	H		Link size	Width		Indent	
		mm	in		mm	in	mm	in
Non Stick	PP-HW <b>B</b>	50.8	2.00	K600	151.0	5.94	0.0	0.00
Non Stick/Support Ribs		76.2	3.00					
		101.6	4.00					

Non Standard material and color: See uni Material and Color Overview.

## Accessories

### Side Guard

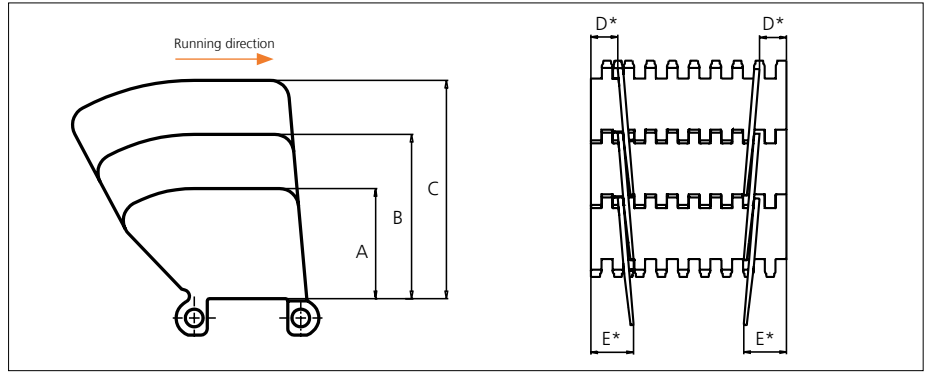

Type	Recommended Material & color	A		B		C		D*		E*	
		mm	in	mm	in	mm	in	mm	in	mm	in
Closed	PP-HW <b>B</b>	51.8	2.04	77.2	3.04	102.6	4.04	21.0	0.83	34.0	1.34

\* Min. indent Increment : 8.4 mm (0.33 in)

Note: Backflex radius when side guard are used: 200.0 mm (7.90 in)

Non Standard material and color: See uni Material and Color Overview.

## Accessories

### Tab

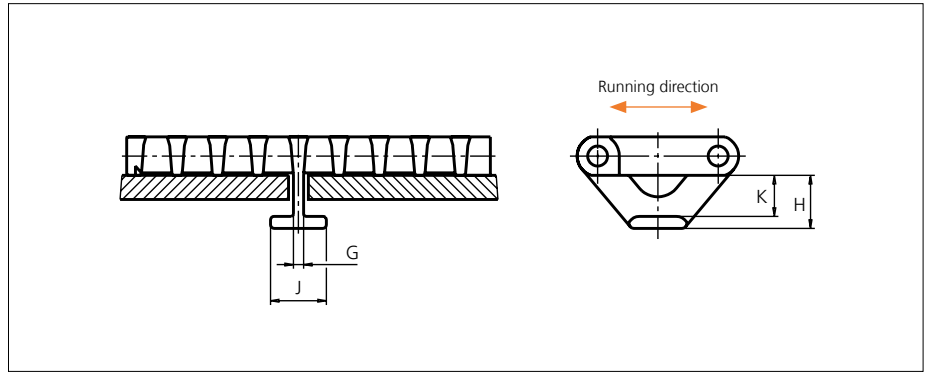

Type	Recommended Material & color	G		H		J		K	
		mm	in	mm	in	mm	in	mm	in
Bottom Hold Down	POM-D <b>N</b>	4.2	0.17	22.0	0.87	23.2	0.92	17.0	0.67
	POM-LF <b>B</b>								
	PP <b>W</b>								

Non Standard material and color: See uni Material and Color Overview.

## Accessories

### Non Standard uni AmFlight

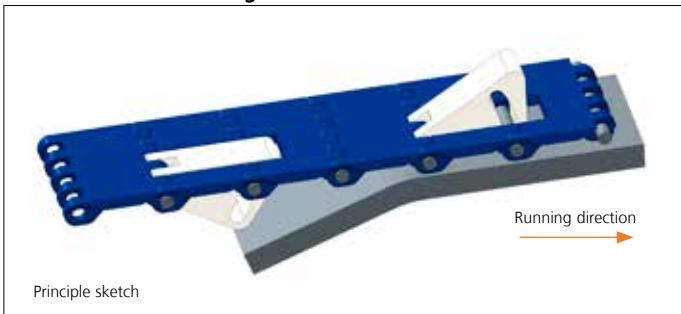

Other Non Standard option: See uni AmFlight Overview.

## Sprocket

No of teeth	Bore size													Overall diameter		Pitch-diameter		Hub-diameter		A-dimension		B-dimension		Single row/Two way	Double row/Two way	Molded PA6 LG	Machined PA6 N
	Pilot Bore	in	0.75	0.78	0.98	1.00	1.18	1.25	1.50	1.57	2.36	2.50	3.54														
	mm	19.1	20.0	25.0	25.4	30.0	31.8	38.1	40.0	60.0	63.5	90.0	mm	in	mm	in	mm	in	mm	in							
Z06	x				●	●	●	■	■				94.5	3.72	100.3	3.95	65	2.56	35.5	1.40	58.6	2.31	x		x		
Z08	x				●	●	●	■	■				129	5.08	131.1	5.16	65	2.56	52.6	2.07	74	2.91	x		x		
Z10	x					●	●	■	■				160.1	6.30	162.4	6.39	65	2.56	69.2	2.72	89.7	3.53	x		x		
Z12	x					●	●	■	■				191.5	7.54	193.9	7.63	65	2.56	85.7	3.37	105.5	4.15	x		x		
Z13	x					●		■	■				207.3	8.16	209.7	8.26	72	2.83	93.8	3.69	113.4	4.46	x		x		
Z13													207.3	8.16	209.7	8.26	150	5.91	93.8	3.69	113.4	4.46	x			x	
Z16	x					●		■	■				254.8	10.03	257.3	10.13	200	7.87	118.2	4.65	137.1	5.40	x			x	

■ Molded sprocket

● Molded sprocket

■ Machined sprocket

● Machined sprocket

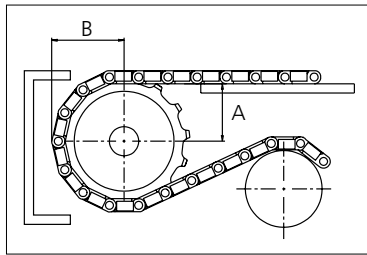
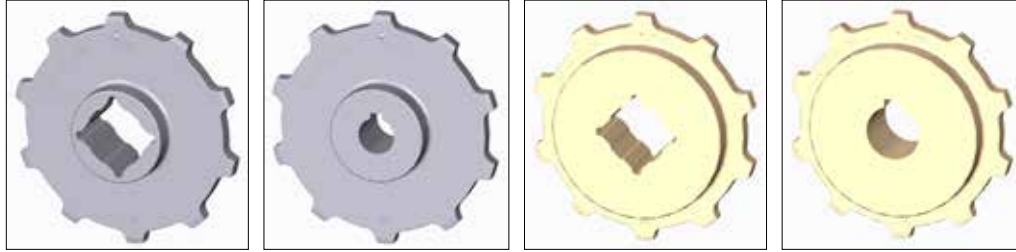

Other sprocket sizes are available upon request.  
 Two-part sprocket are available upon request.  
 Round bores are always delivered with keyway.  
 Other bore sizes are available upon request.  
 uni Retainer Rings: See uni Retainer Ring data sheet  
 Width of tooth = 11.0 mm (0.43 in)  
 Width of sprocket = 42.3 mm (1.67 in)

Max load per sprocket shown does not take bore size into account.  
 Please also ensure that sufficient size shaft is chosen for corresponding load.

For correct sprocket position: See uni Assembly Instructions for uni OPB.  
 For more detailed sprocket information, contact Customer Service.

Non standard material and color: See uni Material and Color Overview.

uni OPB C 4/160707



Expert advice, quality solutions and local service for all your belting needs  
[www.ammeraalbeltech.com](http://www.ammeraalbeltech.com)

**Ammeraal Beltech Modular A/S**  
 Hjulmagervej 21  
 DK-7100 Vejle

T +45 7572 3100  
 F +45 7572 3348  
 admin@unichains.com  
 www.unichains.com

This information is subject to alteration due to continuous development. Ammeraal Beltech will not be held liable for the incorrect use of the above stated information. This information replaces previous information. All activities performed and services rendered by Ammeraal Beltech are subject to general terms and conditions of sale and delivery, as applied by its operating companies.



# Plastic Modular Belt

Series **uni OPB 4** Type **Vacuum**

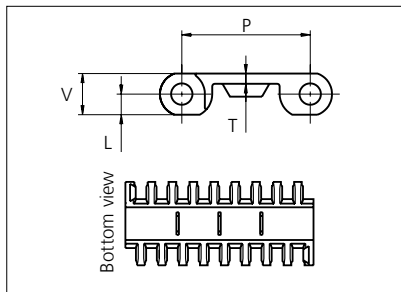

Straight running belt  
 Nominal pitch: 50.0 mm (1.97 in)  
 Surface type: Flat  
 Surface opening:  $\varnothing$ 5.5 mm (0.22 in)  
 Backflex radius: 75.0 mm (3.00 in)  
 Pin diameter: 8 mm (1.97 in)

\*uni-chains recommends this travel direction. However, travel in both directions is possible.

Recommended belt material & color	POM-D <b>W</b>		mm	in		mm	in
		<b>P (Nominal)</b>	50.0	1.97	<b>V</b>	16.0	0.63
Recommended pin and lock material & color	PP <b>W</b>						
		<b>L</b>	8.0	0.31	<b>T</b>	4.0	0.16

Non standard material and color: See uni Material and Color Overview.

Alternative materials: Belt: POM-LF, POM-SLF, PP, PE, PA6.6 and PA6.6H

Rodlock: PP **W**

Endlock: PP **W** **G** **B** and PE **W** **B**

Lockpin: PE **W** PA6.6 **N** PP **W**

Pin: PP **W** PE **W** SS304 and SS316

Belt width		Permissible tensile force (Belt/pin material)						Belt weight (Belt/pin material)						*Min. No. drive sprocket per shaft	Number of wear strips (Min. No.)	
		POM-D/PA6.6		PP/PA6.6		PE/PA6.6		POM-D/PA6.6		PP/PA6.6		PE/PA6.6			**Carry (pcs)	**Return (pcs)
mm	in	N	lbf	N	lbf	N	lbf	kg/m	lb/ft	kg/m	lb/ft	kg/m	lb/ft			
151	5.9	1661	373	831	187	498	112	1.8	1.19	1.1	0.76	1.2	0.82	2	2	2
302	11.9	3322	747	1661	373	997	224	3.5	2.37	2.3	1.52	2.4	1.64	3	3	2
453	17.8	4983	1120	2492	560	1495	336	5.3	3.56	3.4	2.28	3.7	2.47	4	4	2
604	23.8	6644	1494	3322	747	1993	448	7.1	4.75	4.5	3.04	4.9	3.29	5	5	3
755	29.7	8305	1867	4153	933	2492	560	8.8	5.94	5.7	3.81	6.1	4.11	6	6	3
906	35.7	9966	2240	4983	1120	2990	672	10.6	7.12	6.8	4.57	7.3	4.93	7	7	4
1057	41.6	11627	2614	5814	1307	3488	784	12.4	8.31	7.9	5.33	8.6	5.75	8	8	4
1208	47.6	13288	2987	6644	1494	3986	896	14.1	9.50	9.1	6.09	9.8	6.58	9	9	5
1359	53.5	14949	3361	7475	1680	4485	1008	15.9	10.69	10.2	6.85	11.0	7.40	10	10	5
1510	59.4	16610	3734	8305	1867	4983	1120	17.7	11.87	11.3	7.61	12.2	8.22	11	11	6
1661	65.4	18271	4107	9136	2054	5481	1232	19.4	13.06	12.5	8.37	13.5	9.04	12	12	6
1812	71.3	19932	4481	9966	2240	5980	1344	21.2	14.25	13.6	9.13	14.7	9.86	13	13	7
1963	77.3	21593	4854	10797	2427	6478	1456	23.0	15.44	14.7	9.89	15.9	10.69	14	14	7

Additional standard belt widths are available in steps of 151.0 mm (5.94 in). Additional non-standard belt widths are available in steps of 33.6 mm (1.32 in).

2567	101.1	28237	6348	14119	3174	8471	1904	30.0	20.18	19.3	12.94	20.8	13.97	18	18	9
------	-------	-------	------	-------	------	------	------	------	-------	------	-------	------	-------	----	----	---

Additional standard belt widths are available in steps of 151.0 mm (5.94 in). Additional non-standard belt widths are available in steps of 33.6 mm (1.32 in).

2869	113.0	31559	7094	15780	3547	9468	2128	33.6	22.56	21.5	14.46	23.2	15.62	20	20	10
------	-------	-------	------	-------	------	------	------	------	-------	------	-------	------	-------	----	----	----

General belt tolerance is +0/-0.4% at 23°C/73°F and 50% RH. For exact belt width contact Customer Service. Non standard belt width on request.

\*Max. Load per Drive Sprocket. Belt material: POM 2500 N (562 lbf), PP 1200 N (270 lbf), PE 500 N (270 lbf)

\*\*Max. Spacing between wear strips, Carry: 152 mm (6 in); Return: 304 mm (12 in).

= Single Link



NON STANDARD

STRAIGHT RUNNING

PITCH 50.0 MM/1.97 IN

## Accessories

### Tab

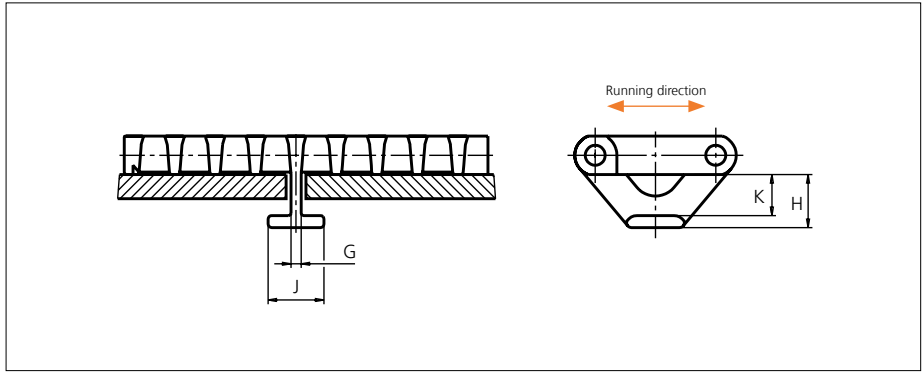

Type	Belt material & color	G		H		J		K	
		mm	in	mm	in	mm	in	mm	in
Bottom Hold Down	POM-D <span style="border: 1px solid black; padding: 0 2px;">N</span>	4.2	0.17	22.0	0.87	23.2	0.92	17.0	0.67
	POM-LF <span style="background-color: #0056b3; color: white; padding: 0 2px;">B</span>								
	PP <span style="border: 1px solid black; padding: 0 2px;">W</span>								

Non Standard material and color: See uni Material and Color Overview.



## Sprocket

No of teeth	Bore size												Overall diameter		Pitch-diameter		Hub-diameter		A-dimension		B-dimension		Single row/Two way	Double row/Two way	Material			
	Pilot Bore	mm	in	0.75	0.78	0.98	1.00	1.18	1.25	1.50	1.57	2.36													2.50	3.54	mm	in
													PA6	PA6 LG														
Z06	x						●	●	●	■	■				94.5	3.72	100.3	3.95	65	2.56	35.5	1.40	58.6	2.31	x		x	
Z08	x						●	●	●	■	■				129	5.08	131.1	5.16	65	2.56	52.6	2.07	74	2.91	x		x	
Z10	x						●	●	●	■	■				160.1	6.30	162.4	6.39	65	2.56	69.2	2.72	89.7	3.53	x		x	
Z12	x						●	●	●	■	■				191.5	7.54	193.9	7.63	65	2.56	85.7	3.37	105.5	4.15	x		x	
Z13	x						●			■	■				207.3	8.16	209.7	8.26	72	2.83	93.8	3.69	113.4	4.46	x		x	
Z13												■			207.3	8.16	209.7	8.26	150	5.91	93.8	3.69	113.4	4.46	x			x
Z16	x						●		■	■	■		■		254.8	10.03	257.3	10.13	200	7.87	118.2	4.65	137.1	5.40	x			x

■ Molded sprocket

● Molded sprocket

■ Machined sprocket

● Machined sprocket

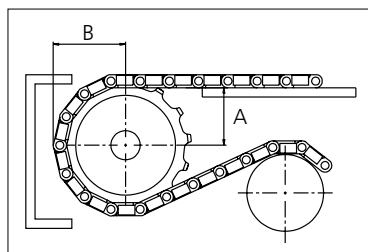
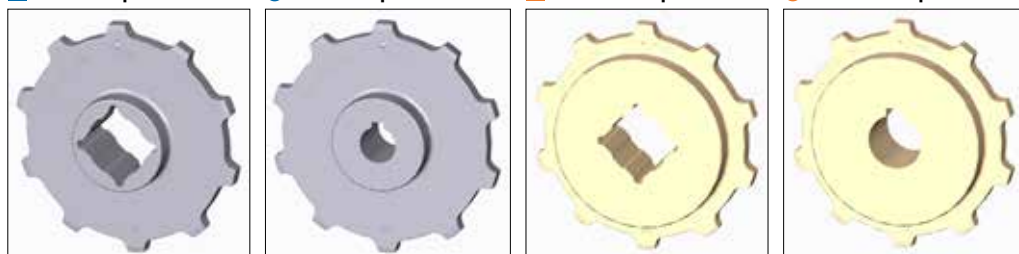

Other sprocket sizes are available upon request.  
 Two-part sprocket are available upon request.  
 Round bores are always delivered with keyway.  
 Other bore sizes are available upon request.  
 uni Retainer Rings: See uni Retainer Ring data sheet  
 Width of tooth = 11.0 mm (0.43 in)  
 Width of sprocket = 42.3 mm (1.67 in)

Max load per sprocket shown does not take bore size into account.  
 Please also ensure that sufficient size shaft is chosen for corresponding load.

For correct sprocket position: See uni Assembly Instructions for uni OPB.  
 For more detailed sprocket information, contact Customer Service.

Non standard material and color: See uni Material and Color Overview.



Conveyor Belts



Seamless Belts

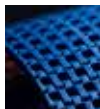

Modular Belts



Timing Belts

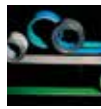

Transmission Belts



Fabrication & service

Solid advice  
For all your belting needs  
Local stock & service  
[www.ammeraalbeltech.com](http://www.ammeraalbeltech.com)

**Ammeraal Beltech Modular A/S**  
Hjulmagervej 21  
DK-7100 Vejle

T +45 7572 3100  
F +45 7572 3348  
admin@unichains.com  
www.unichains.com

This information is subject to alteration due to continuous development. Ammeraal Beltech will not be held liable for the incorrect use of the above stated information. This information replaces previous information. All activities performed and services rendered by Ammeraal Beltech are subject to general terms and conditions of sale and delivery, as applied by its operating companies.



# Plastic Modular Belt

Serie **uni OPB 4V** Type **23% Fine-meshed**

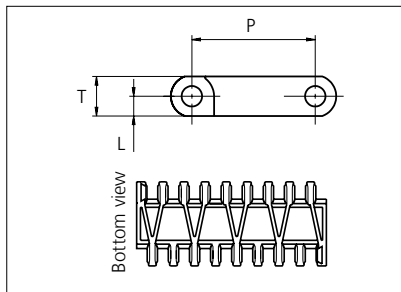

Straight running belt  
 Nominal pitch: 50.0 mm (1.97 in)  
 Surface type: Flat  
 Surface opening: 23%  
 Backflex radius: 75.0 mm (3.00 in)  
 Pin diameter: 8.0 mm (1.97 in)

\*uni-chains recommends this travel direction. However, travel in both directions is possible.

<b>Belt material &amp; color</b>	PP-HW <b>B</b>	PP <b>W</b>		<b>mm</b>	<b>in</b>		<b>mm</b>	<b>in</b>	
<b>Pin and lock material &amp; color</b>	PP-HW <b>LB</b>	PP <b>W</b>		<b>P (Nominal)</b>	50.0	1.97	<b>T</b>	16.0	0.63
				<b>L</b>	8.0	0.31	-	-	-

Non standard material and color: See uni Material and Color Overview.

Alternative pin and lock materials: Trilock: PP-HW **LB** Endlock: PP **W** **G** **B** and PE **W** **B** Lockpin: PE **W** PA6.6 **N** **B** and PBT **LG**  
 Pin: PP **W** PE **W** PBT **LG** SS304 and SS316

Belt width		Permissible tensile force (Belt/pin material)				Belt weight (Belt/pin material)				*Min. No. drive sprocket per shaft	Number of wear strips (Min. No.)	
		PP-HW/PP-HW		PP/PP-HW		PP-HW/PP-HW		PP/PP-HW			**Carry (pcs)	**Return (pcs)
mm	in	N	lbf	N	lbf	kg/m	lb/ft	kg/m	lb/ft			
118	4.6	1296	291	1296	291	0.8	0.54	0.8	0.54	2	2	2
153	6.0	1683	378	1683	378	1.0	0.70	1.0	0.70	2	2	2
186	7.3	2046	460	2046	460	1.3	0.85	1.3	0.85	2	2	2
305	12.0	3355	754	3355	754	2.1	1.39	2.1	1.39	3	3	2
457	18.0	5027	1130	5027	1130	3.1	2.09	3.1	2.09	4	4	2
609	24.0	6699	1506	6699	1506	4.1	2.78	4.1	2.78	5	5	3
761	30.0	8371	1882	8371	1882	5.2	3.48	5.2	3.48	6	6	3
913	35.9	10043	2258	10043	2258	6.2	4.17	6.2	4.17	7	7	4
1065	41.9	11715	2634	11715	2634	7.2	4.87	7.2	4.87	8	8	4
1218	48.0	13398	3012	13398	3012	8.3	5.57	8.3	5.57	9	9	5
1370	53.9	15070	3388	15070	3388	9.3	6.26	9.3	6.26	10	10	5
1522	59.9	16742	3764	16742	3764	10.3	6.96	10.3	6.96	11	11	6
1674	65.9	18414	4139	18414	4139	11.4	7.65	11.4	7.65	12	12	6

Additional standard belt widths are available in steps of 151.5 mm (5.96 in). Additional non-standard belt widths are available in steps of 33.7 mm (1.33 in).

2587	101.9	28457	6397	28457	6397	17.6	11.82	17.6	11.82	18	18	9
------	-------	-------	------	-------	------	------	-------	------	-------	----	----	---

Additional standard belt widths are available in steps of 151.5 mm (5.96 in). Additional non-standard belt widths are available in steps of 33.7 mm (1.33 in).

2891	113.8	31801	7149	31801	7149	19.7	13.21	19.7	13.21	20	20	10
------	-------	-------	------	-------	------	------	-------	------	-------	----	----	----

General belt tolerance is +0/-0.4% at 23°C/73°F and 50% RH. For exact belt width contact Customer Service. Non standard belt width on request.

Belt widths in PP-HW is 0.4 % wider than the belt widths in the table above.

\*Max. Load per Drive Sprocket. Belt material: POM 2500 N (562 lbf), PP 1200 N (270 lbf), PE 500 N (270 lbf)

\*\*Max. Spacing between wear strips, Carry: 152.0 mm (6.00 in); Return: 304.0 mm (12.00 in)

= Single Link



STANDARD

STRAIGHT RUNNING

PITCH 50.0 MM/1.97 IN

## Accessories

### Flight

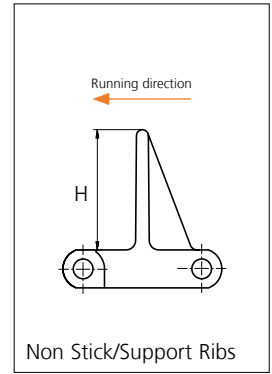
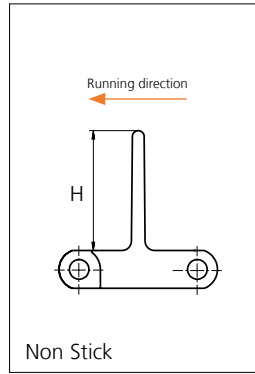

Type	Flight material & color	H		Link size	Width		Indent	
		mm	in		mm	in	mm	in
Non Stick	PP-HW <b>B</b>	50.8	2.00	K600	151.0	5.94	0.0	0.00
Non Stick/ Support Ribs	PP-I <b>W</b>	76.2	3.00					
		101.6	4.00					

Non Standard material and color: See uni Material and Color Overview.

## Accessories

### Side Guard

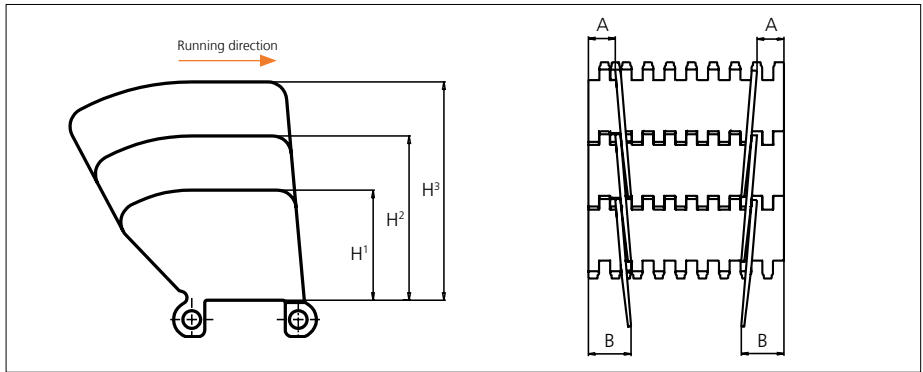

Type	Material & color	H <sup>1</sup>		H <sup>2</sup>		H <sup>3</sup>		A*		B*	
		mm	in	mm	in	mm	in	mm	in	mm	in
Closed	PP-HW <b>B</b> PP-I <b>W</b>	51.8	2.04	77.2	3.04	102.6	4.04	21.0	0.83	34.0	1.34

\* Min. indent Increment : 8.4 mm (0.33 in).

Note: Backflex radius when side guards are used: 200.0 mm (7.90 in)

Non Standard material and color: See uni Material and Color Overview.

## Accessories

### Tab/NON STANDARD

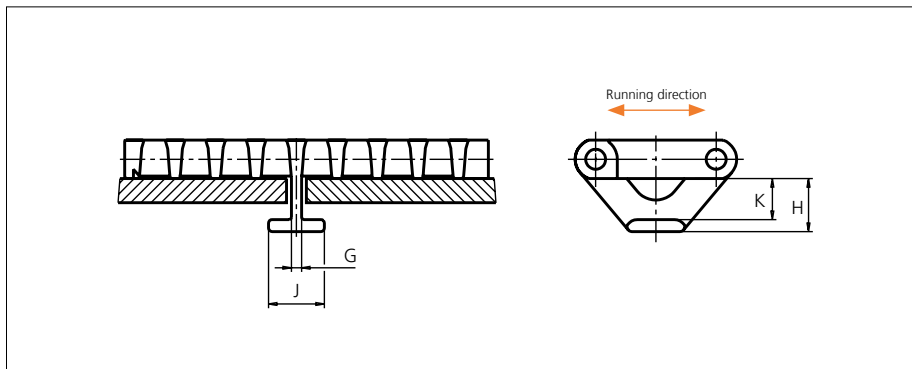

Type	Belt material & color	G		H		J		K	
		mm	in	mm	in	mm	in	mm	in
Bottom Hold Down	POM-D <span style="border: 1px solid black; padding: 0 2px;">N</span>	4.2	0.17	22.0	0.87	23.2	0.92	17.0	0.67
	POM-LF <span style="border: 1px solid black; padding: 0 2px;">B</span>								
	PP <span style="border: 1px solid black; padding: 0 2px;">W</span>								

Non Standard material and color: See uni Material and Color Overview.

## Accessories

### Reinforcement Link

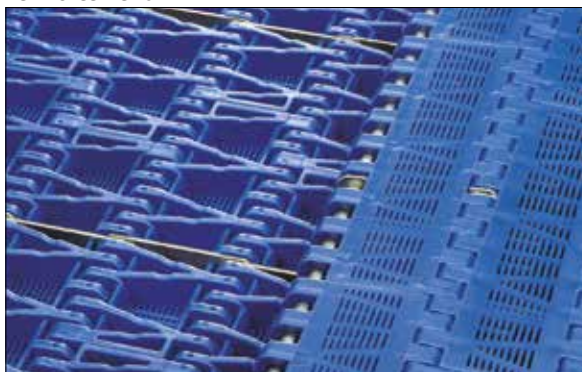

The use of uni-chains belts with the SS reinforcement /pitch control links in blanchers, cookers and other high temperature applications will reduce belt elongation due to temperature by more than 90%. This will simplify the belt take-up system and reduce maintenance.

uni-chains recommends one reinforcement link per K600 module.

Type	Material & color	N/row	Lbf/row
Steel Link	SS316	2500	562

Note: Reinforcement links require the use of SS pins.

Non Standard material and color: See uni Material and Color Overview.

## Sprocket

No of teeth	Bore size							Overall diameter		Pitch-diameter		Hub-diameter		Dimension A		Dimension B		Single row/Two way	Molded	Machined
	Pilot Bore																			
	in	1.00	1.18	1.25	1.50	1.57	2.50	mm	in	mm	in	mm	in	mm	in	mm	in			
Z06	✓		●	●	●	■	■	94.5	3.72	100.3	3.95	65	2.56	35.5	1.40	58.6	2.31	✓	✓	
Z08	✓		●	●	●	■	■	129	5.08	131.1	5.16	65	2.56	52.6	2.07	74	2.91	✓	✓	
Z10	✓			●	●	■	■	160.1	6.30	162.4	6.39	65	2.56	69.2	2.72	89.7	3.53	✓	✓	
Z12	✓			●	●	■	■	191.5	7.54	193.9	7.63	65	2.56	85.7	3.37	105.5	4.15	✓	✓	
Z13	✓			●		■	■	207.3	8.16	209.7	8.26	72	2.83	93.8	3.69	113.4	4.46	✓	✓	
Z13							■	207.3	8.16	209.7	8.26	150	5.91	93.8	3.69	113.4	4.46	✓		✓
Z16	✓			●		■	■	254.8	10.03	257.3	10.13	200	7.87	118.2	4.65	137.1	5.40	✓		✓

■ Molded sprocket    
 ● Molded sprocket    
 ■ Machined sprocket    
 ● Machined sprocket

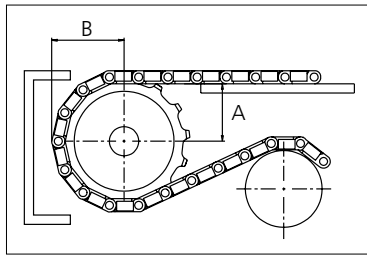
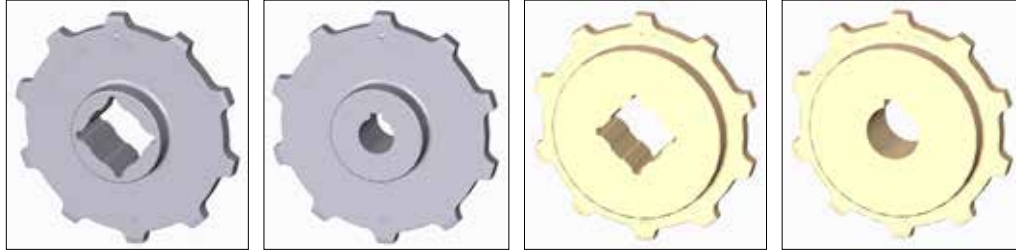

Other sprocket sizes are available upon request.  
 Two-part sprocket are available upon request.  
 Other bore sizes are available upon request  
 uni Retainer Rings: See uni Retainer Ring data sheet  
 Width of tooth = 11.0 mm (0.43 in)  
 Width of sprocket = 42.3 mm (1.67 in)

Max load per sprocket shown does not take bore size into account.  
 Please also ensure that sufficient size shaft is chosen for corresponding load.

For correct sprocket position: See uni Assembly Instructions for uni OPB.  
 For more detailed sprocket information. contact Customer Service.

Non standard material and color: See uni Material and Color Overview.

uni OPB 4V 23% Fine Meshed /2019.09.11



Expert advice, quality solutions and local service for all your belting needs  
[www.ammeraalbeltech.com](http://www.ammeraalbeltech.com)

**Ammeraal Beltech Modular A/S**  
 Hjulmagervej 21  
 DK-7100 Vejle

T +45 7572 3100  
 F +45 7572 3348  
 admin@unichains.com  
 www.unichains.com

This information is subject to alteration due to continuous development. Ammeraal Beltech will not be held liable for the incorrect use of the above stated information. This information replaces previous information. All activities performed and services rendered by Ammeraal Beltech are subject to general terms and conditions of sale and delivery, as applied by its operating companies.



# Plastic Modular Belt

Serie **uni OPB 4V** Type **23% Rib**

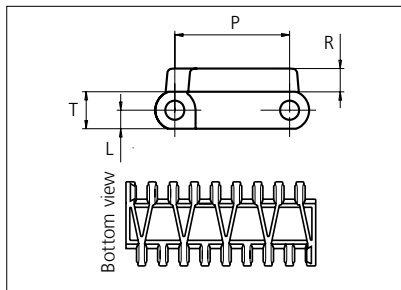
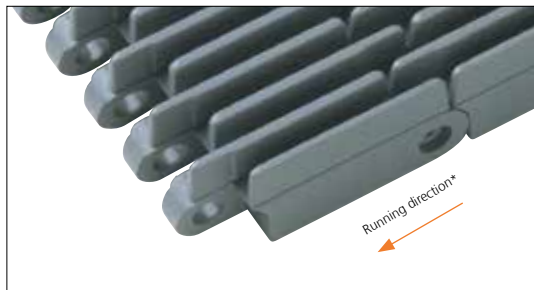

Straight running belt  
 Nominal pitch: 50.0 mm (1.97 in)  
 Surface type: Rib Top  
 Surface opening: 23%  
 Backflex radius: 300.0 mm (11.80 in)  
 Pin diameter: 8.0 mm (1.97 in)

\*uni-chains recommends this travel direction. However, travel in both directions is possible.

Note: uni OPB 36% 4V are listed in the USDA "Accepted Meat and Poultry Equipment" publication as accepted food contact.

Belt material & color	PP-HW <b>LB</b>	PP <b>G</b>	mm	in	P (Nominal)	mm	in
			T	16.0		0.63	50.0
Pin and lock material & color	Trilock: PP-HW <b>LB</b>	Endlock: PP <b>W</b>	L	mm	R	mm	in
	Pin: PP <b>W</b>	PE <b>W</b>	8.0	0.31	10.0	0.39	

Non standard material and color: See uni Material and Color Overview.

Alternative pin and lock materials: Trilock: PP-HW **LB** Endlock: PP **W G B** PE **W B** Lockpin: PP **W** PE **W** PA6.6 **N B** PBT **LG**  
 Pin: PP **W** PE **W** PBT **LG** SS304 and SS316

Belt width		Permissible tensile force (Belt/pin material)				Belt weight (Belt/pin material)				*Min. No. drive sprocket per shaft	Number of wear strips (Min. No.)	
		PP-HW/PP-HW		PP/PP-HW		PP-HW/PP-HW		PP/PP-HW			**Carry (pcs)	**Return (pcs)
mm	in	N	lbf	N	lbf	kg/m	lb/ft	kg/m	lb/ft			
151	5.9	1661	373	1661	373	1.0	0.69	1.0	0.69	2	2	2
302	11.9	3322	747	3322	747	2.1	1.38	2.1	1.38	3	3	2
453	17.8	4983	1120	4983	1120	3.1	2.07	3.1	2.07	4	4	2
604	23.8	6644	1494	6644	1494	4.1	2.76	4.1	2.76	5	5	3
755	29.7	8305	1867	8305	1867	5.1	3.45	5.1	3.45	6	6	3
906	35.7	9966	2240	9966	2240	6.2	4.14	6.2	4.14	7	7	4
1057	41.6	11627	2614	11627	2614	7.2	4.83	7.2	4.83	8	8	4
1208	47.6	13288	2987	13288	2987	8.2	5.52	8.2	5.52	9	9	5
1359	53.5	14949	3361	14949	3361	9.2	6.21	9.2	6.21	10	10	5
1510	59.4	16610	3734	16610	3734	10.3	6.90	10.3	6.90	11	11	6
1661	65.4	18271	4107	18271	4107	11.3	7.59	11.3	7.59	12	12	6
1812	71.3	19932	4481	19932	4481	12.3	8.28	12.3	8.28	13	13	7

Additional standard belt widths are available in steps of 151.0 mm (5.94 in). Additional non-standard belt widths are available in steps of 33.6 mm (1.32 in).

2567	101.1	28237	6348	28237	6348	17.5	11.73	17.5	11.73	18	18	9
------	-------	-------	------	-------	------	------	-------	------	-------	----	----	---

Additional standard belt widths are available in steps of 151.0 mm (5.94 in). Additional non-standard belt widths are available in steps of 33.6 mm (1.32 in).

2869	113.0	31559	7094	31559	7094	19.5	13.11	19.5	13.11	20	20	10
------	-------	-------	------	-------	------	------	-------	------	-------	----	----	----

General belt tolerance is +0/-0.4% at 23°C/73°F and 50% RH. For exact belt width contact Customer Service. Non standard belt width on request.

\*Max. Load per Drive Sprocket. Belt material: POM 2500 N (562 lbf), PP 1200 N (270 lbf), PE 500 N (270 lbf)

\*\*Max. Spacing between wear strips, Carry: 152.0 mm (6.00 in); Return: 304.0 mm (12.00 in).

= Single Link



STANDARD

STRAIGHT RUNNING

PITCH 50.0 MM/1.97 IN

## Accessories

### Finger Plates

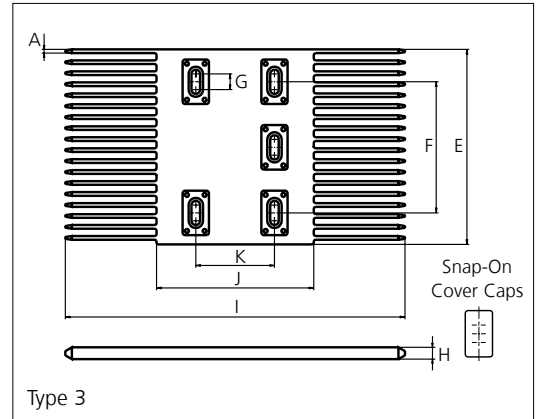
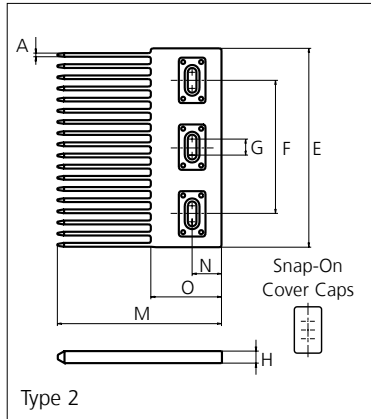
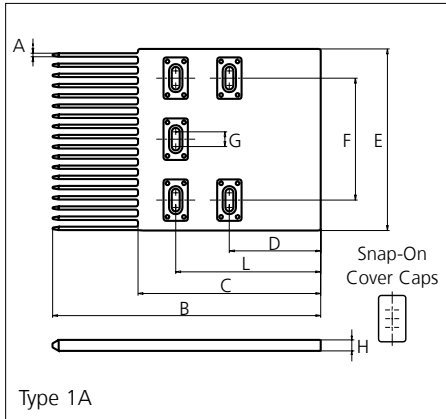
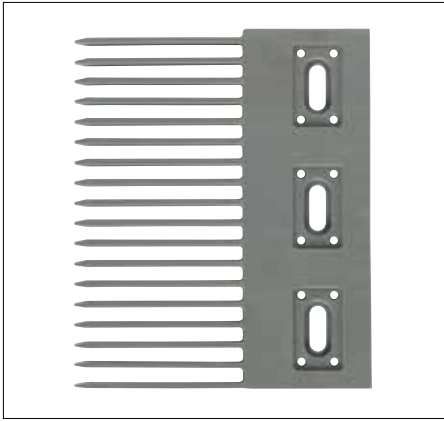

Type	Material & color	A		B		C		D		E		F	
		mm	in	mm	in	mm	in	mm	in	mm	in	mm	in
Single Sided	POM-DI <b>G</b>	2.8	0.11	220.0	8.66	150.0	5.91	75.0	2.95	149.0	5.87	100.0	3.94
Double Sided													

G		H		I		J		K		L		M		N		O	
mm	in	mm	in	mm	in	mm	in	mm	in	mm	in	mm	in	mm	in	mm	in
12.0	0.47	9.0	0.35	259.0	10.20	120.0	4.72	60.0	2.36	119.0	4.69	123.0	4.84	22.0	0.87	53.0	2.09

All uni-chains belt systems are available in a raised rib version that can be supplied with matching finger plates, also called combs.

The finger plates are supplied with cover caps which can be attached when the finger plate has been installed. The cover caps can be removed by using a screwdriver that can be inserted between the cover and finger plate. In order to adjust to belt width variations caused by temperature fluctuations, a slider facilitates the sideways movement of the finger plates.

Non Standard material and color: See uni Material and Color Overview.



## Sprocket

No of teeth	Bore size													Overall diameter		Pitch-diameter		Hub-diameter		Dimension A		Dimension B		Single row/Two way	Double row/Two way	Material	
	Pilot Bore		19.1	20.0	25.0	25.4	30.0	31.8	38.1	40.0	60.0	63.5	90.0													Molded	Machined
	mm	in																									
Z06	x				●	●	●	■	■				94.5	3.72	100.3	3.95	65	2.56	35.5	1.40	58.6	2.31	x		x		
Z08	x				●	●	●	■	■				129	5.08	131.1	5.16	65	2.56	52.6	2.07	74	2.91	x		x		
Z10	x					●	●	■	■				160.1	6.30	162.4	6.39	65	2.56	69.2	2.72	89.7	3.53	x		x		
Z12	x					●	●	■	■				191.5	7.54	193.9	7.63	65	2.56	85.7	3.37	105.5	4.15	x		x		
Z13	x					●		■	■				207.3	8.16	209.7	8.26	72	2.83	93.8	3.69	113.4	4.46	x		x		
Z13											■		207.3	8.16	209.7	8.26	150	5.91	93.8	3.69	113.4	4.46	x			x	
Z16	x					●		■	■		■		254.8	10.03	257.3	10.13	200	7.87	118.2	4.65	137.1	5.40	x			x	

■ Molded sprocket

● Molded sprocket

■ Machined sprocket

● Machined sprocket

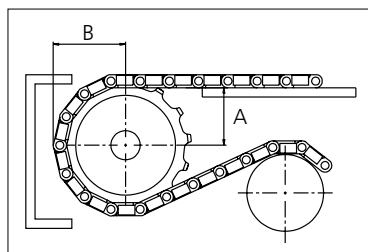
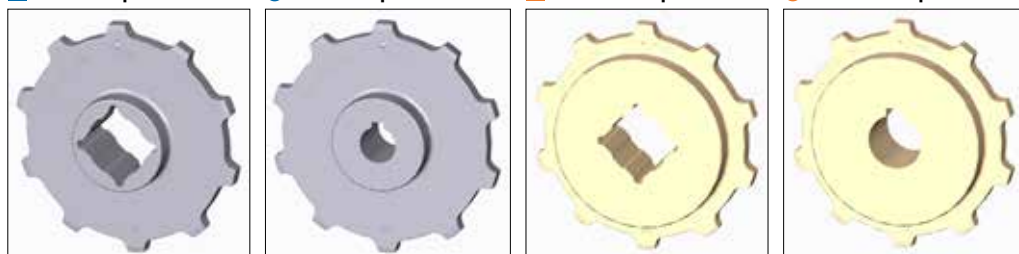

Other sprocket sizes are available upon request.  
 Two-part sprocket are available upon request.  
 Round bores are always delivered with keyway.  
 Other bore sizes are available upon request.  
 uni Retainer Rings: See uni Retainer Ring data sheet  
 Width of tooth = 11.0 mm (0.43 in)  
 Width of sprocket = 42.3 mm (1.67 in)

Max load per sprocket shown does not take bore size into account.  
 Please also ensure that sufficient size shaft is chosen for corresponding load.

For correct sprocket position: See uni Assembly Instructions for uni OPB.  
 For more detailed sprocket information. contact Customer Service.

Non standard material and color: See uni Material and Color Overview.



Conveyor Belts



Seamless Belts

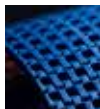

Modular Belts



Timing Belts



Transmission Belts



Fabrication & service

Expert advice, quality solutions and local service for all your belting needs  
[www.ammeraalbeltech.com](http://www.ammeraalbeltech.com)

**Ammeraal Beltech Modular A/S**  
Hjulmagervej 21  
DK-7100 Vejle

T +45 7572 3100  
F +45 7572 3348  
admin@unichains.com  
www.unichains.com

This information is subject to alteration due to continuous development. Ammeraal Beltech will not be held liable for the incorrect use of the above stated information. This information replaces previous information. All activities performed and services rendered by Ammeraal Beltech are subject to general terms and conditions of sale and delivery, as applied by its operating companies.



# Plastic Modular Belt

Serie **uni OPB 4V** Type **23%**

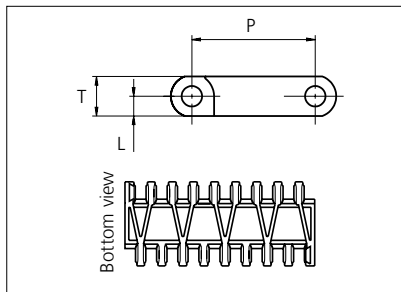

Straight running belt  
 Nominal pitch: 50.0 mm (1.97 in)  
 Surface type: Flat  
 Surface opening: 23%  
 Backflex radius: 75.0 mm (3.00 in)  
 Pin diameter: 8 mm (1.97 in)

\*uni-chains recommends this travel direction. However, travel in both directions is possible.

Note: uni OPB 23% 4V are listed in the USDA "Accepted Meat and Poultry Equipment" publication as accepted food contact.

<b>Belt material &amp; color</b>	PP-HW <b>B</b>		<b>mm</b>	<b>in</b>		<b>mm</b>	<b>in</b>	
<b>Pin and lock material &amp; color</b>	PP-HW <b>LB</b>		<b>P (Nominal)</b>	50.0	1.97	<b>T</b>	16.0	0.63
			<b>L</b>	8.0	0.31	-	-	-

Non standard material and color: See uni Material and Color Overview.

Alternative pin and lock materials: Trilock: PP-HW **LB** Endlock: PP **W** **G** **B** and PE **W** **B** Lockpin: PE **W** PA6.6 **N** **B** and PBT **LG**  
 Pin: PP **W** PE **W** PBT **LG** SS304 and SS316

Belt width		Permissible tensile force (Belt/pin material)				Belt weight (Belt/pin material)				*Min. No. drive sprocket per shaft	Number of wear strips (Min. No.)	
		PP-HW/PP-HW		PP/PP-HW		PP-HW/PP-HW		PP/PP-HW			**Carry (pcs)	**Return (pcs)
mm	in	N	lbf	N	lbf	kg/m	lb/ft	kg/m	lb/ft			
118	4.6	1298	292	1298	292	0.8	0.54	0.8	0.54	2	2	2
151	5.9	1661	373	1661	373	1.0	0.69	1.0	0.69	2	2	2
185	7.3	2035	457	2035	457	1.3	0.85	1.3	0.85	2	2	2
302	11.9	3322	747	3322	747	2.1	1.38	2.1	1.38	3	3	2
453	17.8	4983	1120	4983	1120	3.1	2.07	3.1	2.07	4	4	2
604	23.8	6644	1494	6644	1494	4.1	2.76	4.1	2.76	5	5	3
755	29.7	8305	1867	8305	1867	5.1	3.45	5.1	3.45	6	6	3
906	35.7	9966	2240	9966	2240	6.2	4.14	6.2	4.14	7	7	4
1057	41.6	11627	2614	11627	2614	7.2	4.83	7.2	4.83	8	8	4
1208	47.6	13288	2987	13288	2987	8.2	5.52	8.2	5.52	9	9	5
1359	53.5	14949	3361	14949	3361	9.2	6.21	9.2	6.21	10	10	5
1510	59.4	16610	3734	16610	3734	10.3	6.90	10.3	6.90	11	11	6

Additional standard belt widths are available in steps of 151.0 mm (5.94 in). Additional non-standard belt widths are available in steps of 33.6 mm (1.32 in).

2567	101.1	28237	6348	28237	6348	17.5	11.73	17.5	11.73	18	18	9
------	-------	-------	------	-------	------	------	-------	------	-------	----	----	---

Additional standard belt widths are available in steps of 151.0 mm (5.94 in) Additional non-standard belt widths are available in steps of 33.6 mm (1.32 in).

2869	113.0	31559	7094	31559	7094	19.5	13.11	19.5	13.11	20	20	10
------	-------	-------	------	-------	------	------	-------	------	-------	----	----	----

General belt tolerance is +0/-0.4% at 23°C/73°F and 50% RH. For exact belt width contact Customer Service. Non standard belt width on request.

Belt widths in PP-HW is 0.4 % wider than the belt widths in the table above.

\*Max. Load per Drive Sprocket. Belt material: POM 2500 N (562 lbf), PP 1200 N (270 lbf), PE 500 N (270 lbf).

\*\*Max. Spacing between wear strips, Carry: 152 mm (6 in); Return: 304 mm (12 in).

= Single Link



STANDARD

STRAIGHT RUNNING

PITCH 50.0 MM/1.97 IN

## Accessories

### Flight

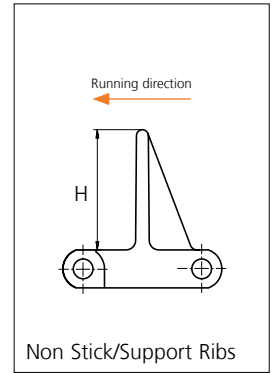
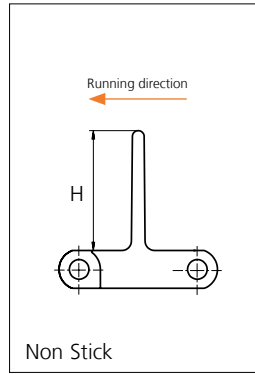

Type	Flight material & color	H		Link size	Width		Indent	
		mm	in		mm	in	mm	in
Non Stick	PP-HW <b>B</b>	50.8	2.00	K600	151.0	5.94	0.0	0.00
Non Stick/ Support Ribs		76.2	3.00					
		101.6	4.00					

Non Standard material and color: See uni Material and Color Overview.

## Accessories

### Side Guard

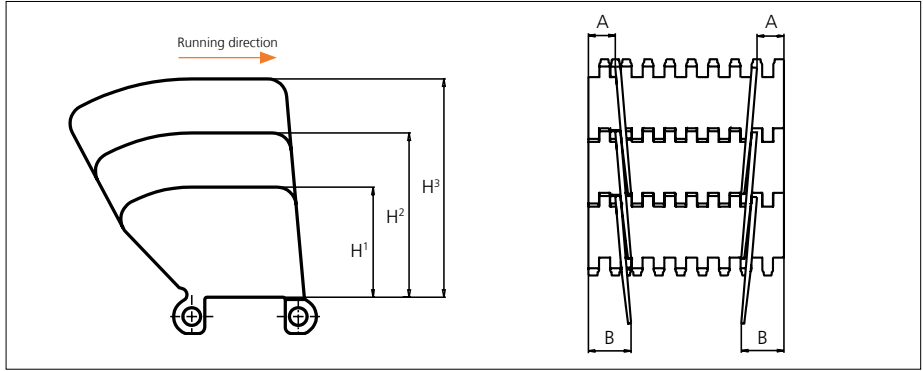

Type	Material & color	H <sup>1</sup>		H <sup>2</sup>		H <sup>3</sup>		A*		B*	
		mm	in	mm	in	mm	in	mm	in	mm	in
Closed	PP-HW <b>B</b>	51.8	2.04	77.2	3.04	102.6	4.04	21.0	0.83	34.0	1.34

\* Min. indent Increment : 8.4 mm (0.33 in)

Note: Backflex radius when side guards are used: 200.0 mm (7.90 in)

Non Standard material and color: See uni Material and Color Overview.

## Accessories

### Tab/NON STANDARD

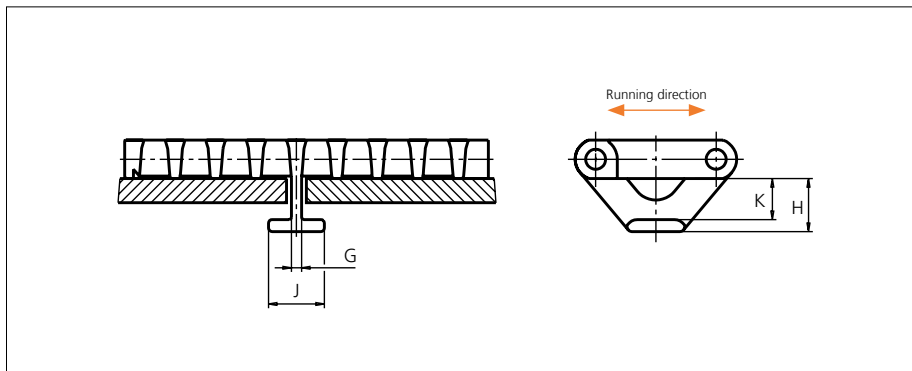

Type	Belt material & color	G		H		J		K	
		mm	in	mm	in	mm	in	mm	in
Bottom Hold Down	POM-D <span style="border: 1px solid black; padding: 0 2px;">N</span>	4.2	0.17	22.0	0.87	23.2	0.92	17.0	0.67
	POM-LF <span style="border: 1px solid black; padding: 0 2px;">B</span>								
	PP <span style="border: 1px solid black; padding: 0 2px;">W</span>								

Non Standard material and color: See uni Material and Color Overview.

## Accessories

### Reinforcement Link

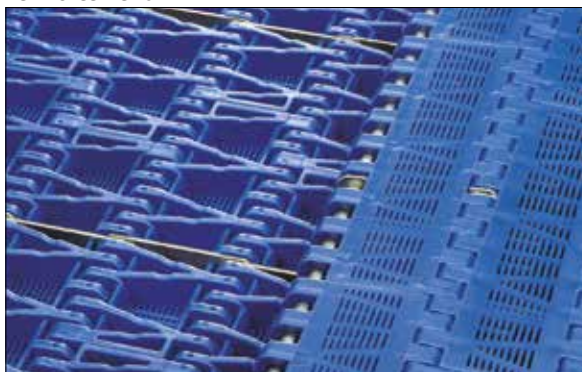

The use of uni-chains belts with the SS reinforcement /pitch control links in blanchers, cookers and other high temperature applications will reduce belt elongation due to temperature by more than 90%. This will simplify the belt take-up system and reduce maintenance.

uni-chains recommends one reinforcement link per K600 module.

Type	Material & color	N/row	Lbf/row
Steel Link	SS316	2500	562

Note: Reinforcement links require the use of SS pins.

Non Standard material and color: See uni Material and Color Overview.

## Sprocket

No of teeth	Bore size													Overall diameter		Pitch-diameter		Hub-diameter		Dimension A		Dimension B		Single row/Two way	Double row/Two way	Molded PA6 LG	Machined PA6 N
	Pilot Bore	in	0.75	0.78	0.98	1.00	1.18	1.25	1.50	1.57	2.36	2.50	3.54														
	mm	19.1	20.0	25.0	25.4	30.0	31.8	38.1	40.0	60.0	63.5	90.0	mm	in	mm	in	mm	in	mm	in							
Z06	x				●	●	●	■	■				94.5	3.72	100.3	3.95	65	2.56	35.5	1.40	58.6	2.31	x		x		
Z08	x				●	●	●	■	■				129	5.08	131.1	5.16	65	2.56	52.6	2.07	74	2.91	x		x		
Z10	x					●	●	■	■				160.1	6.30	162.4	6.39	65	2.56	69.2	2.72	89.7	3.53	x		x		
Z12	x					●	●	■	■				191.5	7.54	193.9	7.63	65	2.56	85.7	3.37	105.5	4.15	x		x		
Z13	x					●		■	■				207.3	8.16	209.7	8.26	72	2.83	93.8	3.69	113.4	4.46	x		x		
Z13													207.3	8.16	209.7	8.26	150	5.91	93.8	3.69	113.4	4.46	x			x	
Z16	x					●		■	■				254.8	10.03	257.3	10.13	200	7.87	118.2	4.65	137.1	5.40	x			x	

■ Molded sprocket

● Molded sprocket

■ Machined sprocket

● Machined sprocket

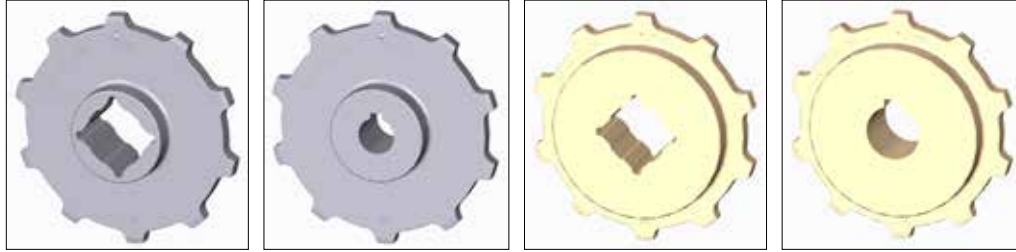

Non standard material and color: See uni Material and Color Overview.

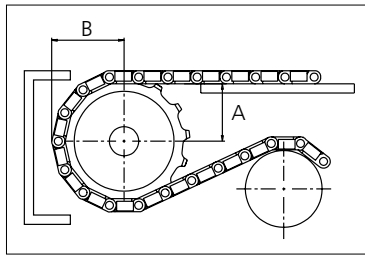

Other sprocket sizes are available upon request.  
 Two-part sprocket are available upon request.  
 Round bores are always delivered with keyway.  
 Other bore sizes are available upon request.  
 uni Retainer Rings: See uni Retainer Ring data sheet  
 Width of tooth = 11.0 mm (0.43 in)  
 Width of sprocket = 42.3 mm (1.67 in)

Max load per sprocket shown does not take bore size into account.  
 Please also ensure that sufficient size shaft is chosen for corresponding load.

For correct sprocket position: See uni Assembly Instructions for uni OPB.  
 For more detailed sprocket information. contact Customer Service.

uni OPB 4V 23%/160707



Expert advice, quality solutions and local service for all your belting needs  
[www.ammeraalbeltech.com](http://www.ammeraalbeltech.com)

**Ammeraal Beltech Modular A/S**  
 Hjulmagervej 21  
 DK-7100 Vejle

T +45 7572 3100  
 F +45 7572 3348  
 admin@unichains.com  
 www.unichains.com

This information is subject to alteration due to continuous development. Ammeraal Beltech will not be held liable for the incorrect use of the above stated information. This information replaces previous information. All activities performed and services rendered by Ammeraal Beltech are subject to general terms and conditions of sale and delivery, as applied by its operating companies.



# Plastic Modular Belt

Serie **uni OPB 4V** Type **36%**

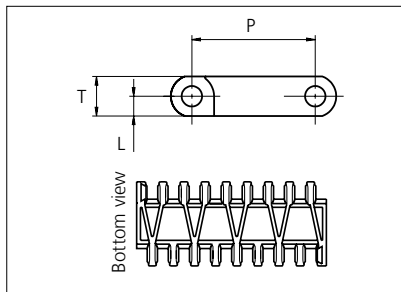

Straight running belt  
 Nominal pitch: 50.0 mm (1.97 in)  
 Surface type: Flat  
 Surface opening: 36%  
 Backflex radius: 75.0 mm (3.00 in)  
 Pin diameter: 8 mm (1.97 in)

\*uni-chains recommends this travel direction. However, travel in both directions is possible.

Note: uni OPB 36% 4V are listed in the USDA "Accepted Meat and Poultry Equipment" publication as accepted food contact.

<b>Belt material &amp; color</b>	PP <b>W</b>	<b>mm</b>	<b>in</b>	<b>mm</b>	<b>in</b>
<b>Pin and lock material &amp; color</b>	PP <b>W</b>	<b>P (Nominal)</b>	50.0	1.97	<b>T</b>
		<b>L</b>	8.0	0.31	-
					16.0
					0.63

Non standard material and color: See uni Material and Color Overview.

Alternative pin and lock materials: Trilock: PP-HW **LB** Endlock: PP **W** **G** **B** and PE **W** **B** Lockpin: PE **W** PA6.6 **N** **B** and PBT **LG**  
 Pin: PP **W** PE **W** PBT **LG** SS304 and SS316

Belt width		Permissible tensile force (Belt/pin material)		Belt weight (Belt/pin material)		*Min. No. drive sprocket per shaft	Number of wear strips (Min. No.)	
		PP/PP		PP/PP			**Carry (pcs)	**Return (pcs)
mm	in	N	lbf	kg/m	lb/ft			
151	5.9	1661	373	1.0	0.65	2	2	2
302	11.9	3322	747	1.9	1.30	3	3	2
453	17.8	4983	1120	2.9	1.95	4	4	2
604	23.8	6644	1494	3.9	2.60	5	5	3
755	29.7	8305	1867	4.8	3.25	6	6	3
906	35.7	9966	2240	5.8	3.90	7	7	4
1057	41.6	11627	2614	6.8	4.55	8	8	4
1208	47.6	13288	2987	7.7	5.20	9	9	5
1359	53.5	14949	3361	8.7	5.85	10	10	5
1510	59.4	16610	3734	9.7	6.49	11	11	6
1661	65.4	18271	4107	10.6	7.14	12	12	6
1812	71.3	19932	4481	11.6	7.79	13	13	7

Additional standard belt widths are available in steps of 151.0 mm (5.94 in). Additional non-standard belt widths are available in steps of 33.6 mm (1.32 in).

2567	101.1	28237	6348	16.4	11.04	18	18	9
------	-------	-------	------	------	-------	----	----	---

Additional standard belt widths are available in steps of 151.0 mm (5.94 in). Additional non-standard belt widths are available in steps of 33.6 mm (1.32 in).

2869	113.0	31559	7094	18.4	12.34	20	20	10
------	-------	-------	------	------	-------	----	----	----

General belt tolerance is +0/-0.4% at 23°C/73°F and 50% RH. For exact belt width contact Customer Service. Non standard belt width on request.

\*Max. Load per Drive Sprocket. Belt material: POM 2500 N (562 lbf), PP 1200 N (270 lbf), PE 500 N (270 lbf)

\*\*Max. Spacing between wear strips, Carry: 152 mm (6 in); Return: 304 mm (12 in).

= Single Link



STANDARD

STRAIGHT RUNNING

PITCH 50.0 MM/1.97 IN

## Accessories

### Flight

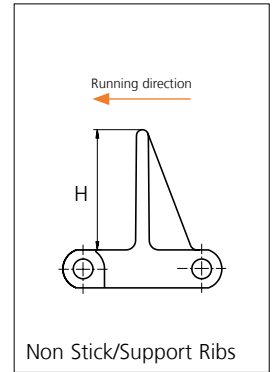
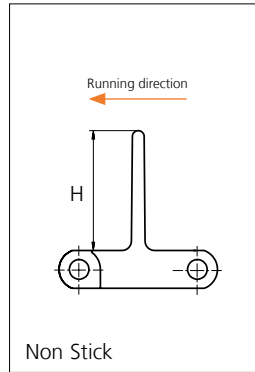

Type	Flight material & color	H		Link size	Width		Indent	
		mm	in		mm	in	mm	in
Non Stick	PP-HW <b>B</b>	50.8	2.00	K600	151.0	5.94	0.0	0.00
Non Stick/ Support Ribs		76.2	3.00					
		101.6	4.00					

Non Standard material and color: See uni Material and Color Overview.

## Accessories

### Side Guard

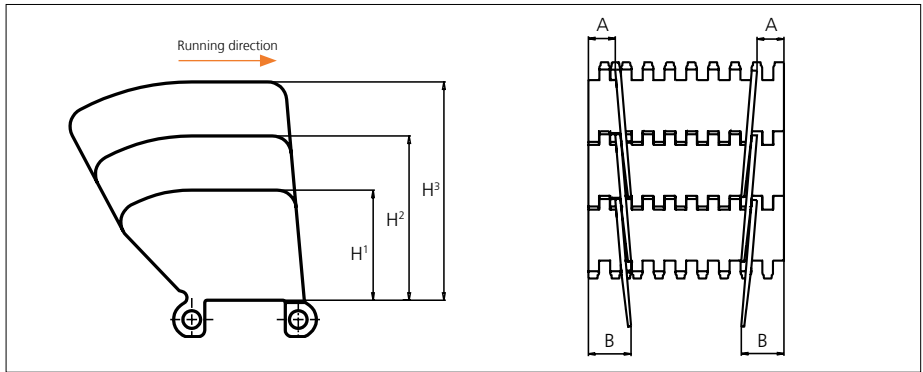

Type	Material & color	H <sup>1</sup>		H <sup>2</sup>		H <sup>3</sup>		A*		B*	
		mm	in	mm	in	mm	in	mm	in	mm	in
Closed	PP-HW <b>B</b>	51.8	2.04	77.2	3.04	102.6	4.04	21.0	0.83	34.0	1.34

\* Min. indent Increment : 8.4 mm (0.33 in)

Note: Backflex radius when side guards are used: 200.0 mm (7.90 in)

Non Standard material and color: See uni Material and Color Overview.



### Accessories

#### Tab/NON STANDARD

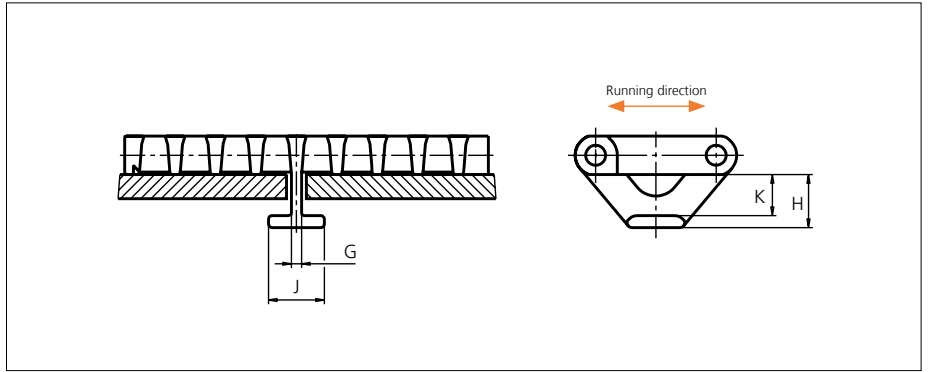

Type	Belt material & color	G		H		J		K	
		mm	in	mm	in	mm	in	mm	in
Bottom Hold Down	POM-D <span style="border: 1px solid black; padding: 0 2px;">N</span>	4.2	0.17	22.0	0.87	23.2	0.92	17.0	0.67
	POM-LF <span style="background-color: #0056b3; color: white; padding: 0 2px;">B</span>								
	PP <span style="border: 1px solid black; padding: 0 2px;">W</span>								

Non Standard material and color: See uni Material and Color Overview.

## Sprocket

No of teeth	Bore size													Overall diameter		Pitch-diameter		Hub-diameter		Dimension A		Dimension B		Single row/Two way	Double row/Two way	Molded PA6 LG	Machined PA6 N
	Pilot Bore	in	0.75	0.78	0.98	1.00	1.18	1.25	1.50	1.57	2.36	2.50	3.54														
	mm	19.1	20.0	25.0	25.4	30.0	31.8	38.1	40.0	60.0	63.5	90.0	mm	in	mm	in	mm	in	mm	in							
Z06	x				●	●	●	■	■				94.5	3.72	100.3	3.95	65	2.56	35.5	1.40	58.6	2.31	x		x		
Z08	x				●	●	●	■	■				129	5.08	131.1	5.16	65	2.56	52.6	2.07	74	2.91	x		x		
Z10	x					●	●	■	■				160.1	6.30	162.4	6.39	65	2.56	69.2	2.72	89.7	3.53	x		x		
Z12	x					●	●	■	■				191.5	7.54	193.9	7.63	65	2.56	85.7	3.37	105.5	4.15	x		x		
Z13	x					●		■	■				207.3	8.16	209.7	8.26	72	2.83	93.8	3.69	113.4	4.46	x		x		
Z13											■		207.3	8.16	209.7	8.26	150	5.91	93.8	3.69	113.4	4.46	x			x	
Z16	x					●		■	■		■		254.8	10.03	257.3	10.13	200	7.87	118.2	4.65	137.1	5.40	x			x	

■ Molded sprocket

● Molded sprocket

■ Machined sprocket

● Machined sprocket

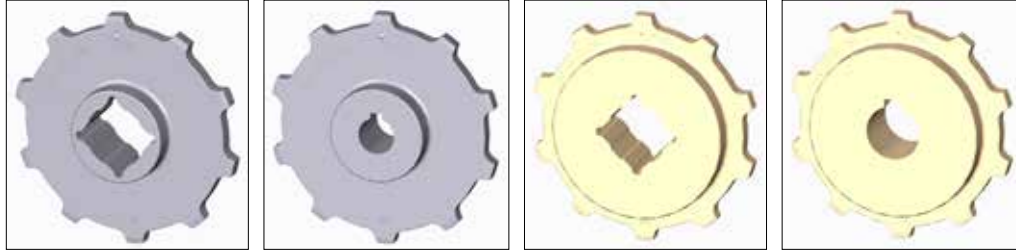

Non standard material and color: See uni Material and Color Overview.

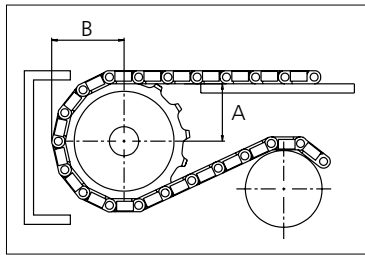

Other sprocket sizes are available upon request.  
 Two-part sprocket are available upon request.  
 Round bores are always delivered with keyway.  
 Other bore sizes are available upon request.  
 uni Retainer Rings: See uni Retainer Ring data sheet  
 Width of tooth = 11.0 mm (0.43 in)  
 Width of sprocket = 42.3 mm (1.67 in)

Max load per sprocket shown does not take bore size into account.  
 Please also ensure that sufficient size shaft is chosen for corresponding load.

For correct sprocket position: See uni Assembly Instructions for uni OPB.  
 For more detailed sprocket information, contact Customer Service.

uni OPB 4V 36%/160707



Expert advice, quality solutions and local service for all your belting needs  
[www.ammeraalbeltech.com](http://www.ammeraalbeltech.com)

**Ammeraal Beltech Modular A/S**  
 Hjulmagervej 21  
 DK-7100 Vejle

T +45 7572 3100  
 F +45 7572 3348  
 admin@unichains.com  
 www.unichains.com

This information is subject to alteration due to continuous development. Ammeraal Beltech will not be held liable for the incorrect use of the above stated information. This information replaces previous information. All activities performed and services rendered by Ammeraal Beltech are subject to general terms and conditions of sale and delivery, as applied by its operating companies.



# Plastic Modular Belt

Series **uni OPB 4V** Type **C**

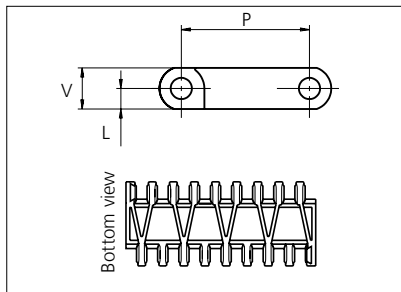

Straight running belt  
 Nominal pitch: 50.0 mm (1.97 in)  
 Surface type: Flat  
 Surface opening: Closed  
 Backflex radius: 75.0 mm (3.00 in)  
 Pin diameter: 8 mm (1.97 in)

\*uni-chains recommends this travel direction. However, travel in both directions is possible.

Recommended belt material & color	POM-D <b>W</b>		mm	in		mm	in
		<b>P (Nominal)</b>	50.0	1.97	<b>V</b>	16.0	0.63
Recommended pin and lock material & color	PP <b>W</b>		mm	in		mm	in
		<b>L</b>	8.0	0.31	-	-	-

Non standard material and color: See uni Material and Color Overview.

Alternative materials: Belt: POM-LF, POM-SLF, PP, PE, PA6.6, PA6.6H  
 Lockpin: PE **W** PA6.6 **N** PP **W**

Rodlock: PP **W** Endlock: PP **W** **G** **B** PE **W** **B**  
 Pin: PP **W** PE **W** SS304, SS316

Belt width		Permissible tensile force (Belt/pin material)						Belt weight (Belt/pin material)						*Min. No. drive sprocket per shaft	Number of wear strips (Min. No.)	
		POM-D/PA6.6		PP/PA6.6		PE/PA6.6		POM-D/PA6.6		PP/PA6.6		PE/PA6.6			**Carry (pcs)	**Return (pcs)
mm	in	N	lbf	N	lbf	N	lbf	kg/m	lb/ft	kg/m	lb/ft	kg/m	lb/ft			
118	4.6	2596	584	1298	292	779	175	1.4	0.93	0.9	0.59	1.0	0.64	2	2	2
151	5.9	3322	747	1661	373	997	224	1.8	1.19	1.1	0.76	1.2	0.82	2	2	2
185	7.3	4070	915	2035	457	1221	274	2.2	1.45	1.4	0.93	1.5	1.01	2	2	2
302	11.9	6644	1494	3322	747	1993	448	3.5	2.37	2.3	1.52	2.4	1.64	3	3	2
453	17.8	9966	2240	4983	1120	2990	672	5.3	3.56	3.4	2.28	3.7	2.47	4	4	2
604	23.8	13288	2987	6644	1494	3986	896	7.1	4.75	4.5	3.04	4.9	3.29	5	5	3
755	29.7	16610	3734	8305	1867	4983	1120	8.8	5.94	5.7	3.81	6.1	4.11	6	6	3
906	35.7	19932	4481	9966	2240	5980	1344	10.6	7.12	6.8	4.57	7.3	4.93	7	7	4
1057	41.6	23254	5227	11627	2614	6976	1568	12.4	8.31	7.9	5.33	8.6	5.75	8	8	4
1208	47.6	26576	5974	13288	2987	7973	1792	14.1	9.50	9.1	6.09	9.8	6.58	9	9	5
1359	53.5	29898	6721	14949	3361	8969	2016	15.9	10.69	10.2	6.85	11.0	7.40	10	10	5
1510	59.4	33220	7468	16610	3734	9966	2240	17.7	11.87	11.3	7.61	12.2	8.22	11	11	6
1661	65.4	36542	8215	18271	4107	10963	2464	19.4	13.06	12.5	8.37	13.5	9.04	12	12	6

Additional standard belt widths are available in steps of 151.0 mm (5.94 in). Additional non-standard belt widths are available in steps of 33.6 mm (1.32 in).

2567	101.1	56474	12695	28237	6348	16942	3809	30.0	20.18	19.3	12.94	20.8	13.97	18	18	9
------	-------	-------	-------	-------	------	-------	------	------	-------	------	-------	------	-------	----	----	---

Additional standard belt widths are available in steps of 151.0 mm (5.94 in). Additional non-standard belt widths are available in steps of 33.6 mm (1.32 in).

2869	113.0	63118	14189	31559	7094	18935	4257	33.6	22.56	21.5	14.46	23.2	15.62	20	20	10
------	-------	-------	-------	-------	------	-------	------	------	-------	------	-------	------	-------	----	----	----

General belt tolerance is +0/-0.4% at 23°C/73°F and 50% RH. For exact belt width contact Customer Service. Non standard belt width on request.

\*Max. Load per Drive Sprocket. Belt material: POM 2500 N (562 lbf), PP 1200 N (270 lbf), PE 500 N (270 lbf)

\*\*Max. Spacing between wear strips, Carry: 152 mm (6 in); Return: 304 mm (12 in).

= Single Link



NON STANDARD

STRAIGHT RUNNING

PITCH 50.0 MM/1.97 IN

## Accessories

### Rubber Top

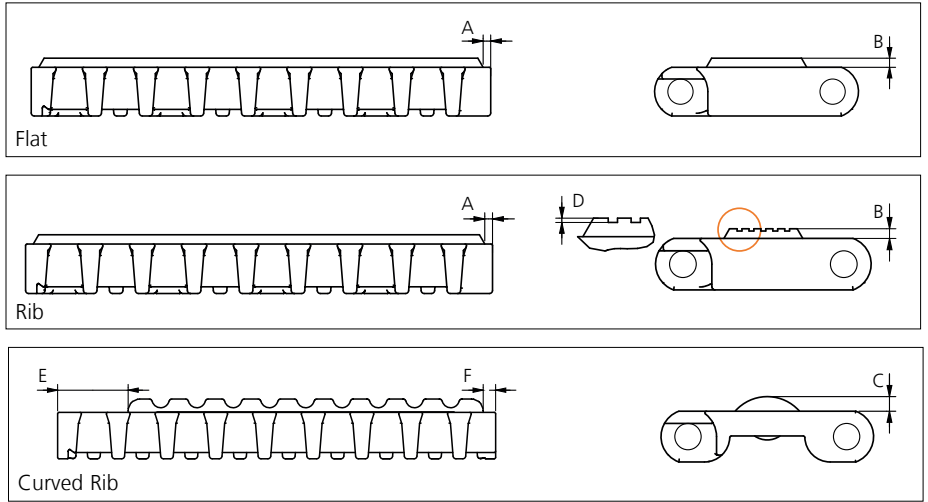

Type	Belt Material & color	Rubber Material & color	A		B		C		D		E		F		Link size	Width	
			mm	in	mm	in	mm	in	mm	in	mm	in	mm	in		mm	in
Flat	POM-LF <b>BR</b>	03 <b>N</b>															
Rib	POM-D <b>W</b>		2.5	0.10	3.0	0.12	4.5	0.18	0.7	0.03	24.0	0.94	4.0	0.16	K600	150.5	5.93
Curved Rib	POM-D <b>W</b>	03 <b>K</b>															

Other Non Standard Rubber profiles: See uni Rubber Profile Overview.

## Accessories

### Flight

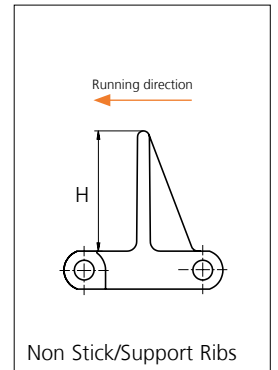
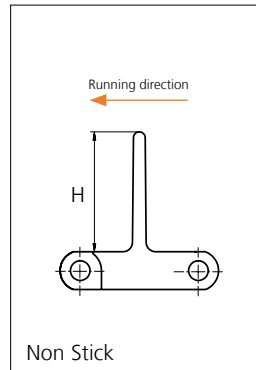

Type	Recommended Material & color	H		Link size	Width		Indent	
		mm	in		mm	in	mm	in
Non Stick	PP-HW <b>B</b>	50.8	2.00	K600	151.0	5.94	0.0	0.00
Non Stick/		76.2	3.00					
Support Ribs		101.6	4.00					

Non Standard material and color: See uni Material and Color Overview.

## Accessories

### Side Guard

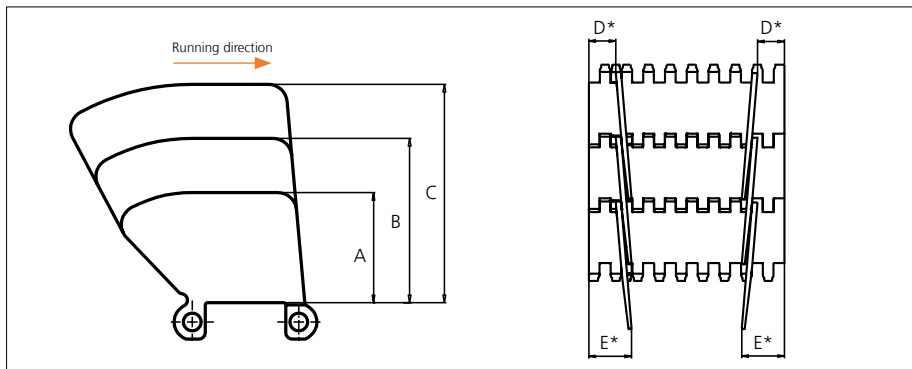

Type	Recommended Material & color	A		B		C		D*		E*	
		mm	in	mm	in	mm	in	mm	in	mm	in
Closed	PP-HW <b>B</b>	51.8	2.04	77.2	3.04	102.6	4.04	21.0	0.83	34.0	1.34

\* Min. indent Increment : 8.4 mm (0.33 in)

Note: Backflex radius when side guard are used: 200.0 mm (7.90 in)

Non Standard material and color: See uni Material and Color Overview.

## Accessories

### Tab

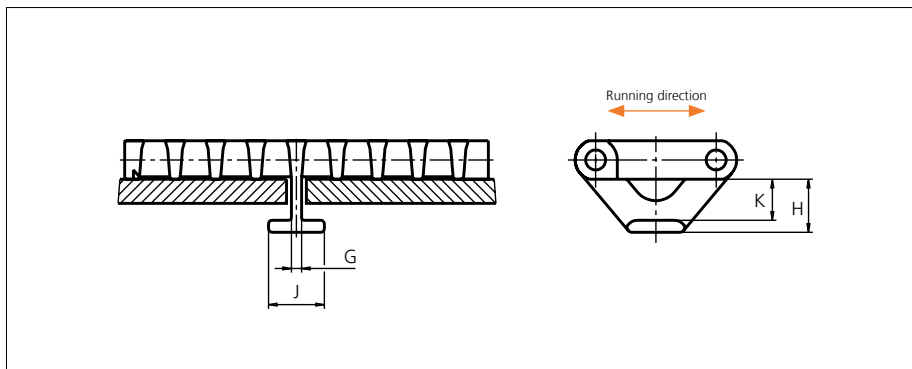

Type	Recommended Material & color	G		H		J		K	
		mm	in	mm	in	mm	in	mm	in
Bottom Hold Down	POM-D <b>N</b>	4.2	0.17	22.0	0.87	23.2	0.92	17.0	0.67
	POM-LF <b>B</b>								
	PP <b>W</b>								

Non Standard material and color: See uni Material and Color Overview.

## Accessories

### Non Standard uni AmFlight

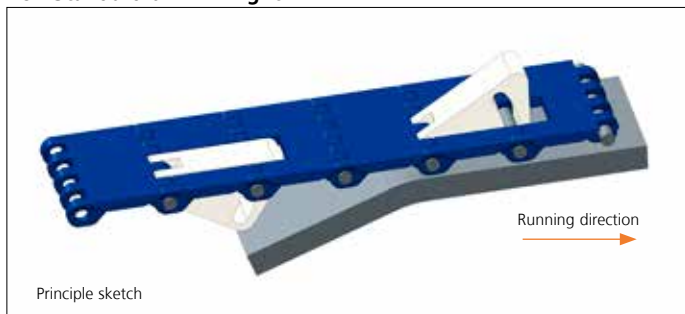

Other Non Standard option: See uni AmFlight Overview.

## Sprocket

No of teeth	Bore size													Overall diameter		Pitch-diameter		Hub-diameter		Dimension A		Dimension B		Single row/Two way	Double row/Two way	Molded PA6 LG	Machined PA6 N
	Pilot Bore	in	0.75	0.78	0.98	1.00	1.18	1.25	1.50	1.57	2.36	2.50	3.54														
	mm	19.1	20.0	25.0	25.4	30.0	31.8	38.1	40.0	60.0	63.5	90.0	mm	in	mm	in	mm	in	mm	in							
Z06	x				●	●	●	■	■				94.5	3.72	100.3	3.95	65	2.56	35.5	1.40	58.6	2.31	x		x		
Z08	x				●	●	●	■	■				129	5.08	131.1	5.16	65	2.56	52.6	2.07	74	2.91	x		x		
Z10	x					●	●	■	■				160.1	6.30	162.4	6.39	65	2.56	69.2	2.72	89.7	3.53	x		x		
Z12	x					●	●	■	■				191.5	7.54	193.9	7.63	65	2.56	85.7	3.37	105.5	4.15	x		x		
Z13	x					●		■	■				207.3	8.16	209.7	8.26	72	2.83	93.8	3.69	113.4	4.46	x		x		
Z13													207.3	8.16	209.7	8.26	150	5.91	93.8	3.69	113.4	4.46	x			x	
Z16	x					●		■	■				254.8	10.03	257.3	10.13	200	7.87	118.2	4.65	137.1	5.40	x			x	

■ Molded sprocket

● Molded sprocket

■ Machined sprocket

● Machined sprocket

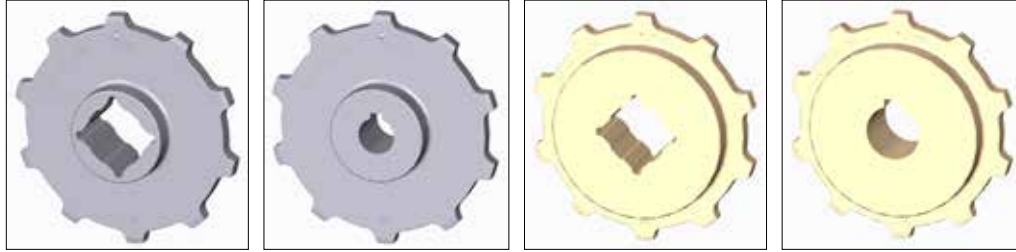

Non standard material and color: See uni Material and Color Overview.

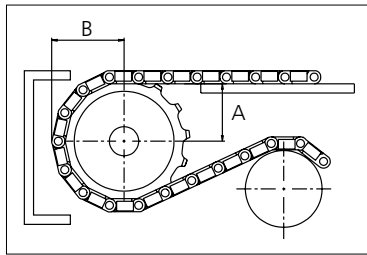

Other sprocket sizes are available upon request.  
 Two-part sprocket are available upon request.  
 Round bores are always delivered with keyway.  
 Other bore sizes are available upon request.  
 uni Retainer Rings: See uni Retainer Ring data sheet  
 Width of tooth = 11.0 mm (0.43 in)  
 Width of sprocket = 42.3 mm (1.67 in)

Max load per sprocket shown does not take bore size into account.  
 Please also ensure that sufficient size shaft is chosen for corresponding load.

For correct sprocket position: See uni Assembly Instructions for uni OPB.  
 For more detailed sprocket information, contact Customer Service.

uni OPB 4V C/160707



**Solid advice**  
 For all your belting needs  
 Local stock & service  
[www.ammeraalbeltech.com](http://www.ammeraalbeltech.com)

**Ammeraal Beltech Modular A/S**  
 Hjulmagervej 21  
 DK-7100 Vejle

T +45 7572 3100  
 F +45 7572 3348  
 admin@unichains.com  
 www.unichains.com

This information is subject to alteration due to continuous development. Ammeraal Beltech will not be held liable for the incorrect use of the above stated information. This information replaces previous information. All activities performed and services rendered by Ammeraal Beltech are subject to general terms and conditions of sale and delivery, as applied by its operating companies.



# Plastic Modular Belt

Series **uni OPB 4V** Type **Rough**

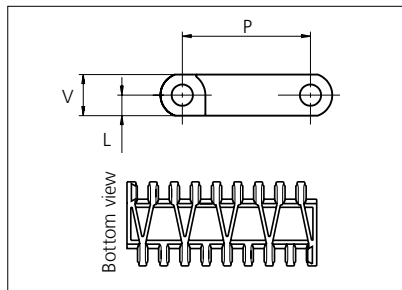

Straight running belt  
 Nominal pitch: 50.0 mm (1.97 in)  
 Surface type: Rough Top  
 Surface opening: Closed  
 Backflex radius: 75.0 mm (3.00 in)  
 Pin diameter: 8 mm (1.97 in)

\*uni-chains recommends this travel direction. However, travel in both directions is possible.

Recommended belt material & color	POM-D <b>W</b>	mm	in	mm	in		
		<b>P (Nominal)</b>	50.0	1.97	<b>V</b>	16.0	0.63
Recommended pin and lock material & color	PP <b>W</b>	L	8.0	0.31	-	-	-

Non standard material and color: See uni Material and Color Overview.

Alternative materials: Belt: POM-LF, POM-SLF, PP, PE, PA6.6 and PA6.6H

Rodlock: PP **W**

Endlock: PP **W** **G** **B** and PE **W** **B**

Lockpin: PE **W** PA6.6 **N** PP **W**

Pin: PP **W** PE **W** SS304 and SS316

Belt width		Permissible tensile force (Belt/pin material)						Belt weight (Belt/pin material)						*Min. No. drive sprocket per shaft	Number of wear strips (Min. No.)	
		POM-D/PA6.6		PP/PA6.6		PE/PA6.6		POM-D/PA6.6		PP/PA6.6		PE/PA6.6			**Carry (pcs)	**Return (pcs)
mm	in	N	lbf	N	lbf	N	lbf	kg/m	lb/ft	kg/m	lb/ft	kg/m	lb/ft			
151	5.9	3322	747	1661	373	997	224	1.8	1.19	1.1	0.76	1.2	0.82	2	2	2
302	11.9	6644	1494	3322	747	1993	448	3.5	2.37	2.3	1.52	2.4	1.64	3	3	2
453	17.8	9966	2240	4983	1120	2990	672	5.3	3.56	3.4	2.28	3.7	2.47	4	4	2
604	23.8	13288	2987	6644	1494	3986	896	7.1	4.75	4.5	3.04	4.9	3.29	5	5	3
755	29.7	16610	3734	8305	1867	4983	1120	8.8	5.94	5.7	3.81	6.1	4.11	6	6	3
906	35.7	19932	4481	9966	2240	5980	1344	10.6	7.12	6.8	4.57	7.3	4.93	7	7	4
1057	41.6	23254	5227	11627	2614	6976	1568	12.4	8.31	7.9	5.33	8.6	5.75	8	8	4
1208	47.6	26576	5974	13288	2987	7973	1792	14.1	9.50	9.1	6.09	9.8	6.58	9	9	5
1359	53.5	29898	6721	14949	3361	8969	2016	15.9	10.69	10.2	6.85	11.0	7.40	10	10	5
1510	59.4	33220	7468	16610	3734	9966	2240	17.7	11.87	11.3	7.61	12.2	8.22	11	11	6
1661	65.4	36542	8215	18271	4107	10963	2464	19.4	13.06	12.5	8.37	13.5	9.04	12	12	6
1812	71.3	39864	8961	19932	4481	11959	2688	21.2	14.25	13.6	9.13	14.7	9.86	13	13	7
1963	77.3	43186	9708	21593	4854	12956	2912	23.0	15.44	14.7	9.89	15.9	10.69	14	14	7

Additional standard belt widths are available in steps of 151.0 mm (5.94 in). Additional non-standard belt widths are available in steps of 33.6 mm (1.32 in).

2567	101.1	56474	12695	28237	6348	16942	3809	30.0	20.18	19.3	12.94	20.8	13.97	18	18	9
------	-------	-------	-------	-------	------	-------	------	------	-------	------	-------	------	-------	----	----	---

Additional standard belt widths are available in steps of 151.0 mm (5.94 in). Additional non-standard belt widths are available in steps of 33.6 mm (1.32 in).

2869	113.0	63118	14189	31559	7094	18935	4257	33.6	22.56	21.5	14.46	23.2	15.62	20	20	10
------	-------	-------	-------	-------	------	-------	------	------	-------	------	-------	------	-------	----	----	----

General belt tolerance is +0/-0.4% at 23°C/73°F and 50% RH. For exact belt width contact Customer Service. Non standard belt width on request.

\*Max. Load per Drive Sprocket. Belt material: POM 2500 N (562 lbf), PP 1200 N (270 lbf), PE 500 N (270 lbf)

\*\*Max. Spacing between wear strips, Carry: 152 mm (6 in); Return: 304 mm (12 in).

= Single Link



NON STANDARD

STRAIGHT RUNNING

PITCH 50.0 MM/1.97 IN

## Accessories

### Tab

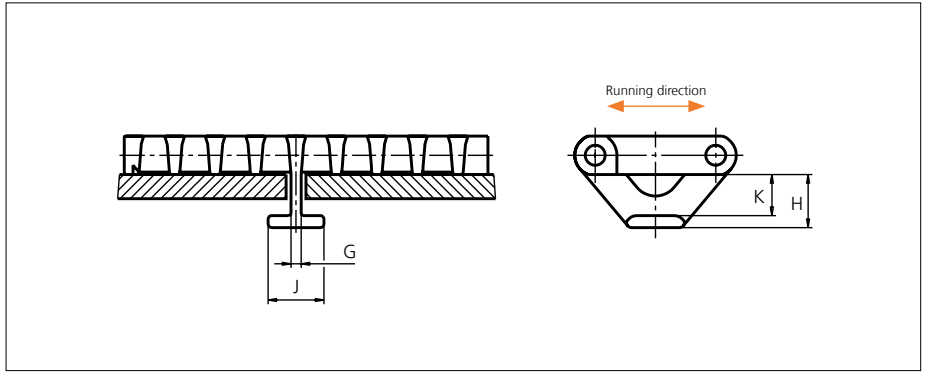

Type	Recommended material & color	G		H		J		K	
		mm	in	mm	in	mm	in	mm	in
Bottom Hold Down	POM-D	4.2	0.17	22.0	0.87	23.2	0.92	17.0	0.67
	POM-LF								
	PP								

Non Standard material and color: See uni Material and Color Overview.



## Sprocket

No. of teeth	Pilot Bore	Bore size											Overall diameter		Pitch-diameter		Hub-diameter		Dimension A		Dimension B		Single row/Two way	Double row/Two way	Machined											
		mm	in	mm	in	mm	in	mm	in	mm	in	mm													in	mm	in	mm	in	PA6 LG	PA6 N					
		19.1	0.75	0.78	0.98	1.00	1.18	1.25	1.50	1.57	2.36	2.50	3.54	60.0	63.5	90.0	mm	in	mm	in	mm	in			mm	in	mm	in	mm	in	mm	in	mm	in	mm	in
Z06	x					●	●	●	■	■						94.5	3.72	100.3	3.95	65	2.56	35.5	1.40	58.6	2.31	x		x								
Z08	x					●	●	●	■	■						129	5.08	131.1	5.16	65	2.56	52.6	2.07	74	2.91	x		x								
Z10	x						●	●	■	■						160.1	6.30	162.4	6.39	65	2.56	69.2	2.72	89.7	3.53	x		x								
Z12	x						●	●	■	■						191.5	7.54	193.9	7.63	65	2.56	85.7	3.37	105.5	4.15	x		x								
Z13	x						●		■	■						207.3	8.16	209.7	8.26	72	2.83	93.8	3.69	113.4	4.46	x		x								
Z13														■		207.3	8.16	209.7	8.26	150	5.91	93.8	3.69	113.4	4.46	x									x	
Z16	x					●		■	■	■				■		254.8	10.03	257.3	10.13	200	7.87	118.2	4.65	137.1	5.40	x									x	

■ Molded sprocket

● Molded sprocket

■ Machined sprocket

● Machined sprocket

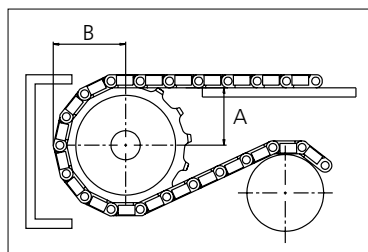
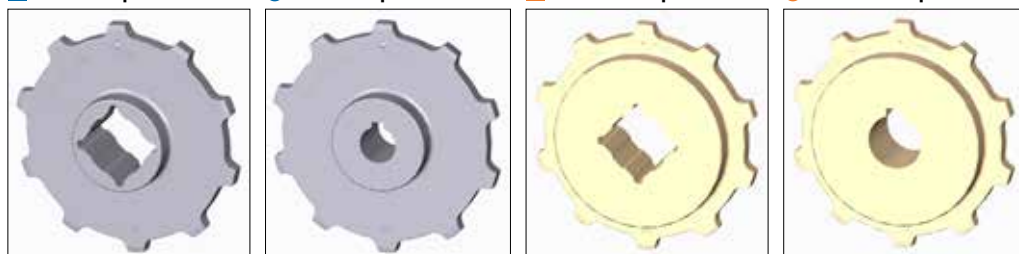

Other sprocket sizes are available upon request.  
 Two-part sprocket are available upon request.  
 Round bores are always delivered with keyway.  
 Other bore sizes are available upon request.  
 uni Retainer Rings: See uni Retainer Ring data sheet  
 Width of tooth = 11.0 mm (0.43 in)  
 Width of sprocket = 42.3 mm (1.67 in)

Max load per sprocket shown does not take bore size into account.  
 Please also ensure that sufficient size shaft is chosen for corresponding load.

For correct sprocket position: See uni Assembly Instructions for uni OPB.  
 For more detailed sprocket information, contact Customer Service.

Non standard material and color: See uni Material and Color Overview.



Conveyor Belts



Seamless Belts

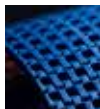

Modular Belts



Timing Belts

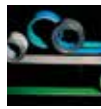

Transmission Belts



Fabrication & service

Solid advice  
For all your belting needs  
Local stock & service  
[www.ammeraalbeltech.com](http://www.ammeraalbeltech.com)

**Ammeraal Beltech Modular A/S**  
Hjulmagervej 21  
DK-7100 Vejle

T +45 7572 3100  
F +45 7572 3348  
admin@unichains.com  
www.unichains.com

This information is subject to alteration due to continuous development. Ammeraal Beltech will not be held liable for the incorrect use of the above stated information. This information replaces previous information. All activities performed and services rendered by Ammeraal Beltech are subject to general terms and conditions of sale and delivery, as applied by its operating companies.



# Plastic Modular Belt

Series **uni OPB 4V** Type **Vacuum**

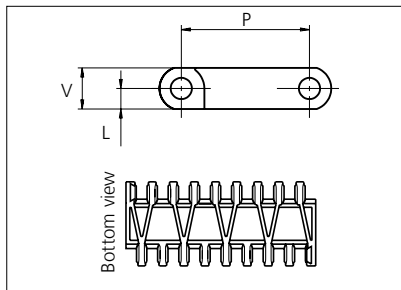

Straight running belt  
 Nominal pitch: 50.0 mm (1.97 in)  
 Surface type: Flat  
 Surface opening: ø5.5 mm (0.22 in)  
 Backflex radius: 75.0 mm (3.00 in)  
 Pin diameter: 8 mm (1.97 in)

\*uni-chains recommends this travel direction. However, travel in both directions is possible.

Recommended belt material & color	POM-D <b>W</b>	mm	in	mm	in		
		<b>P (Nominal)</b>	50.0	1.97	<b>V</b>	16.0	0.63
Recommended pin and lock material & color	PP <b>W</b>	L	8.0	0.31	-	-	-

Non standard material and color: See uni Material and Color Overview.

Alternative materials: Belt: POM-LF, POM-SLF, PP, PE, PA6.6 and PA6.6H

Rodlock: PP **W**

Endlock: PP **W** **G** **B** and PE **W** **B**

Lockpin: PE **W** PA6.6 **N** PP **W**

Pin: PP **W** PE **W** SS304 and SS316

Belt width		Permissible tensile force (Belt/pin material)						Belt weight (Belt/pin material)						*Min. No. drive sprocket per shaft	Number of wear strips (Min. No.)	
		POM-D/PA6.6		PP/PA6.6		PE/PA6.6		POM-D/PA6.6		PP/PA6.6		PE/PA6.6			**Carry (pcs)	**Return (pcs)
mm	in	N	lbf	N	lbf	N	lbf	kg/m	lb/ft	kg/m	lb/ft	kg/m	lb/ft			
151	5.9	3322	747	1661	373	997	224	1.8	1.19	1.1	0.76	1.2	0.82	2	2	2
302	11.9	6644	1494	3322	747	1993	448	3.5	2.37	2.3	1.52	2.4	1.64	3	3	2
453	17.8	9966	2240	4983	1120	2990	672	5.3	3.56	3.4	2.28	3.7	2.47	4	4	2
604	23.8	13288	2987	6644	1494	3986	896	7.1	4.75	4.5	3.04	4.9	3.29	5	5	3
755	29.7	16610	3734	8305	1867	4983	1120	8.8	5.94	5.7	3.81	6.1	4.11	6	6	3
906	35.7	19932	4481	9966	2240	5980	1344	10.6	7.12	6.8	4.57	7.3	4.93	7	7	4
1057	41.6	23254	5227	11627	2614	6976	1568	12.4	8.31	7.9	5.33	8.6	5.75	8	8	4
1208	47.6	26576	5974	13288	2987	7973	1792	14.1	9.50	9.1	6.09	9.8	6.58	9	9	5
1359	53.5	29898	6721	14949	3361	8969	2016	15.9	10.69	10.2	6.85	11.0	7.40	10	10	5
1510	59.4	33220	7468	16610	3734	9966	2240	17.7	11.87	11.3	7.61	12.2	8.22	11	11	6
1661	65.4	36542	8215	18271	4107	10963	2464	19.4	13.06	12.5	8.37	13.5	9.04	12	12	6
1812	71.3	39864	8961	19932	4481	11959	2688	21.2	14.25	13.6	9.13	14.7	9.86	13	13	7
1963	77.3	43186	9708	21593	4854	12956	2912	23.0	15.44	14.7	9.89	15.9	10.69	14	14	7

Additional standard belt widths are available in steps of 151.0 mm (5.94 in). Additional non-standard belt widths are available in steps of 33.6 mm (1.32 in).

2567	101.1	56474	12695	28237	6348	16942	3809	30.0	20.18	19.3	12.94	20.8	13.97	18	18	9
------	-------	-------	-------	-------	------	-------	------	------	-------	------	-------	------	-------	----	----	---

Additional standard belt widths are available in steps of 151.0 mm (5.94 in). Additional non-standard belt widths are available in steps of 33.6 mm (1.32 in).

2869	113.0	63118	14189	31559	7094	18935	4257	33.6	22.56	21.5	14.46	23.2	15.62	20	20	10
------	-------	-------	-------	-------	------	-------	------	------	-------	------	-------	------	-------	----	----	----

General belt tolerance is +0/-0.4% at 23°C/73°F and 50% RH. For exact belt width contact Customer Service. Non standard belt width on request

\*Max. Load per Drive Sprocket. Belt material: POM 2500 N (562 lbf), PP 1200 N (270 lbf), PE 500 N (270 lbf)

\*\*Max. Spacing between wear strips, Carry: 152 mm (6 in); Return: 304 mm (12 in)

= Single Link



NON STANDARD

STRAIGHT RUNNING

PITCH 50.0 MM/1.97 IN

## Accessories

### Tab

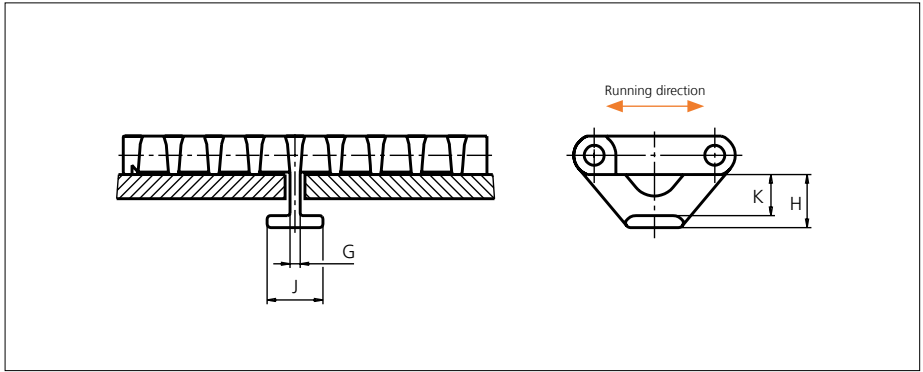

Type	Recommended material & color	G		H		J		K	
		mm	in	mm	in	mm	in	mm	in
Bottom Hold Down	POM-D <span style="border: 1px solid black; padding: 0 2px;">N</span>	4.2	0.17	22.0	0.87	23.2	0.92	17.0	0.67
	POM-LF <span style="background-color: #0056b3; color: white; padding: 0 2px;">B</span>								
	PP <span style="border: 1px solid black; padding: 0 2px;">W</span>								

Non Standard material and color: See uni Material and Color Overview.

## Sprocket

No. of teeth	Bore size													Overall diameter		Pitch-diameter		Hub-diameter		Dimension A		Dimension B		Single row/Two way	Double row/Two way	Machined					
	Pilot Bore	mm	in	0.75	0.78	0.98	1.00	1.18	1.25	1.50	1.57	2.36	2.50													3.54	60.0	63.5	90.0	mm	in
														19.1	20.0	25.0	25.4	30.0	31.8	38.1	40.0	60.0	63.5	90.0	mm						
Z06	x						●	●	●	■	■							94.5	3.72	100.3	3.95	65	2.56	35.5	1.40	58.6	2.31	x		x	
Z08	x						●	●	●	■	■							129	5.08	131.1	5.16	65	2.56	52.6	2.07	74	2.91	x		x	
Z10	x							●	●	■	■							160.1	6.30	162.4	6.39	65	2.56	69.2	2.72	89.7	3.53	x		x	
Z12	x							●	●	■	■							191.5	7.54	193.9	7.63	65	2.56	85.7	3.37	105.5	4.15	x		x	
Z13	x							●		■	■							207.3	8.16	209.7	8.26	72	2.83	93.8	3.69	113.4	4.46	x		x	
Z13															■			207.3	8.16	209.7	8.26	150	5.91	93.8	3.69	113.4	4.46	x			x
Z16	x						●		■	■	■				■			254.8	10.03	257.3	10.13	200	7.87	118.2	4.65	137.1	5.40	x			x

■ Molded sprocket

● Molded sprocket

■ Machined sprocket

● Machined sprocket

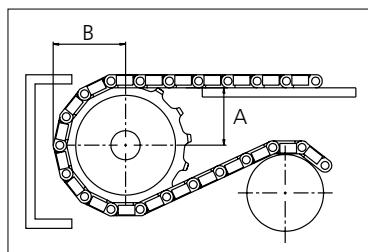
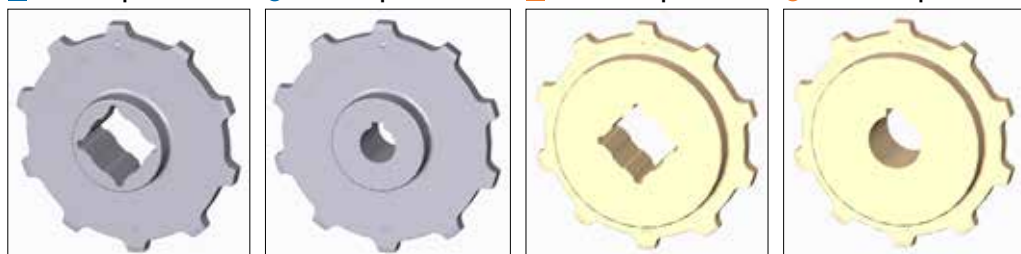

Other sprocket sizes are available upon request.  
 Two-part sprocket are available upon request.  
 Round bores are always delivered with keyway.  
 Other bore sizes are available upon request.  
 uni Retainer Rings: See uni Retainer Ring data sheet  
 Width of tooth = 11.0 mm (0.43 in)  
 Width of sprocket = 42.3 mm (1.67 in)

Max load per sprocket shown does not take bore size into account.  
 Please also ensure that sufficient size shaft is chosen for corresponding load.

For correct sprocket position: See uni Assembly Instructions for uni OPB.  
 For more detailed sprocket information, contact Customer Service.

Non standard material and color: See uni Material and Color Overview.



Conveyor Belts



Seamless Belts



Modular Belts



Timing Belts

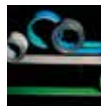

Transmission Belts



Fabrication & service

Solid advice  
For all your belting needs  
Local stock & service  
[www.ammeraalbeltech.com](http://www.ammeraalbeltech.com)

**Ammeraal Beltech Modular A/S**  
Hjulmagervej 21  
DK-7100 Vejle

T +45 7572 3100  
F +45 7572 3348  
admin@unichains.com  
www.unichains.com

This information is subject to alteration due to continuous development. Ammeraal Beltech will not be held liable for the incorrect use of the above stated information. This information replaces previous information. All activities performed and services rendered by Ammeraal Beltech are subject to general terms and conditions of sale and delivery, as applied by its operating companies.



# Plastic Modular Belt

Series **uni OPB 8** Type **20%**

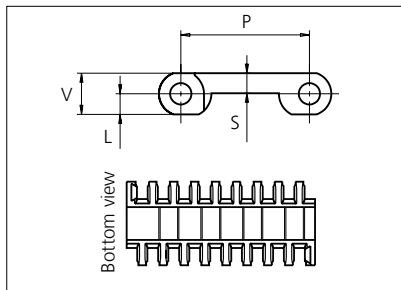

Straight running belt  
 Nominal pitch: 50.0 mm (1.97 in)  
 Surface type: Flat  
 Surface opening: 20%  
 Backflex radius: 75.0 mm (3.00 in)  
 Pin diameter: 8 mm (1.97 in)

\*uni-chains recommends this travel direction. However, travel in both directions is possible.

Recommended belt material & color	POM-D <b>W</b>		mm	in		mm	in
		<b>P (Nominal)</b>	50.0	1.97	<b>V</b>	16.0	0.63
Recommended pin and lock material & color	PP <b>W</b>						
		<b>L</b>	8.0	0.31	<b>S</b>	7.8	0.31

Non standard material and color: See uni Material and Color Overview.

Alternative materials: Belt: POM-LF, POM-SLF, PP, PE, PA6.6 and PA6.6H

Rodlock: PP **W**

Endlock: PP **W** **G** **B** and PE **W** **B**

Lockpin: PE **W** PA6.6 **N** PP **W**

Pin: PP **W** PE **W** SS304 and SS316

Belt width		Permissible tensile force (Belt/pin material)						Belt weight (Belt/pin material)						*Min. No. drive sprocket per shaft	Number of wear strips (Min. No.)	
		POM-D/PA6.6		PP/PA6.6		PE/PA6.6		POM-D/PA6.6		PP/PA6.6		PE/PA6.6			**Carry (pcs)	**Return (pcs)
mm	in	N	lbf	N	lbf	N	lbf	kg/m	lb/ft	kg/m	lb/ft	kg/m	lb/ft			
118	4.6	2596	584	1298	292	779	175	1.2	0.80	0.8	0.55	0.9	0.58	2	2	2
151	5.9	3322	747	1661	373	997	224	1.5	1.02	1.0	0.70	1.1	0.74	2	2	2
185	7.3	4070	915	2035	457	1221	274	1.9	1.26	1.3	0.86	1.4	0.91	2	2	2
302	11.9	6644	1494	3322	747	1993	448	3.1	2.05	2.1	1.40	2.2	1.48	3	3	2
453	17.8	9966	2240	4983	1120	2990	672	4.6	3.07	3.1	2.10	3.3	2.22	4	4	2
604	23.8	13288	2987	6644	1494	3986	896	6.1	4.10	4.2	2.80	4.4	2.96	5	5	3
755	29.7	16610	3734	8305	1867	4983	1120	7.6	5.12	5.2	3.50	5.5	3.70	6	6	3
906	35.7	19932	4481	9966	2240	5980	1344	9.2	6.15	6.3	4.20	6.6	4.44	7	7	4
1057	41.6	23254	5227	11627	2614	6976	1568	10.7	7.17	7.3	4.90	7.7	5.19	8	8	4
1208	47.6	26576	5974	13288	2987	7973	1792	12.2	8.20	8.3	5.60	8.8	5.93	9	9	5
1359	53.5	29898	6721	14949	3361	8969	2016	13.7	9.22	9.4	6.30	9.9	6.67	10	10	5
1510	59.4	33220	7468	16610	3734	9966	2240	15.3	10.25	10.4	7.00	11.0	7.41	11	11	6
1661	65.4	36542	8215	18271	4107	10963	2464	16.8	11.27	11.5	7.70	12.1	8.15	12	12	6

Additional standard belt widths are available in steps of 151.0 mm (5.94 in.) Additional non-standard belt widths are available in steps of 33.6 mm (1.32 in.)

2567	101.1	56474	12695	28237	6348	16942	3809	25.9	17.42	17.7	11.90	18.7	12.59	18	18	9
------	-------	-------	-------	-------	------	-------	------	------	-------	------	-------	------	-------	----	----	---

Additional standard belt widths are available in steps of 151.0 mm (5.94 in.) Additional non-standard belt widths are available in steps of 33.6 mm (1.32 in.)

2869	113.0	63118	14189	31559	7094	18935	4257	29.0	19.47	19.8	13.30	20.9	14.08	20	20	10
------	-------	-------	-------	-------	------	-------	------	------	-------	------	-------	------	-------	----	----	----

General belt tolerance is +0/-0.4% at 23°C/73°F and 50% RH. For exact belt width contact Customer Service. Non standard belt width on request.

\*Max. Load per Drive Sprocket. Belt material: POM 2500 N (562 lbf), PP 1200 N (270 lbf), PE 500 N (270 lbf)

\*\*Max. Spacing between wear strips, Carry: 152 mm (6 in.); Return: 304 mm (12 in.)

= Single Link



NON STANDARD

STRAIGHT RUNNING

PITCH 50.0 MM/1.97 IN

## Accessories

### Flight

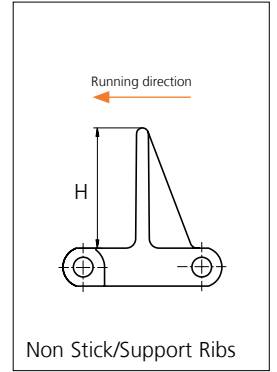
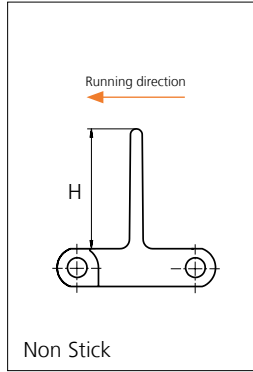

Type	Recommended Material & color	H		Link size	Width		Indent	
		mm	in		mm	in	mm	in
Non Stick	PP-HW <b>B</b>	50.8	2.00	K600	151.0	5.94	0.0	0.00
Non Stick/ Support Ribs		76.2	3.00					
		101.6	4.00					

Non Standard material and color: See uni Material and Color Overview.

## Accessories

### Side Guard

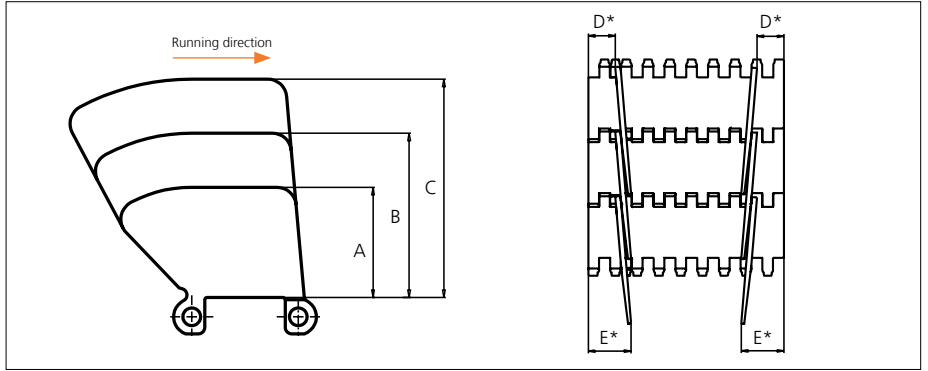

Type	Recommended Material & color	A		B		C		D*		E*	
		mm	in	mm	in	mm	in	mm	in	mm	in
Closed	PP-HW <b>B</b>	51.8	2.04	77.2	3.04	102.6	4.04	21.0	0.83	34.0	1.34

\* Min. indent Increment : 8.4 mm (0.33 in)

Note: Backflex radius when side guards are used: 200.0 mm (7.90 in)

Non Standard material and color: See uni Material and Color Overview.



## Accessories

### Tab

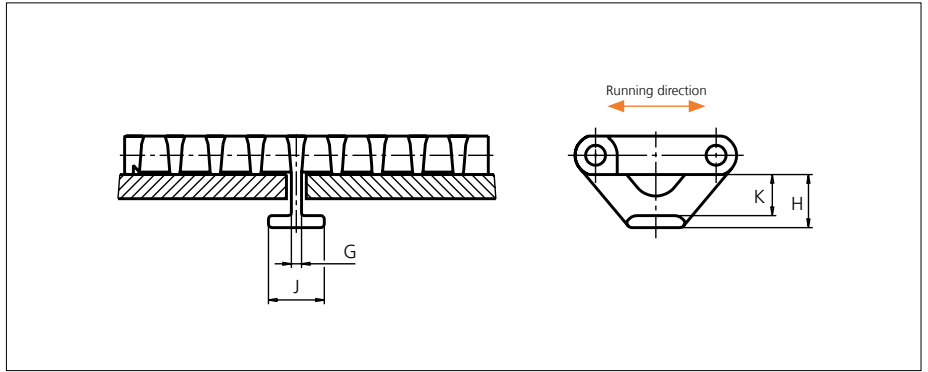

Type	Recommended material & color	G		H		J		K	
		mm	in	mm	in	mm	in	mm	in
Bottom Hold Down	POM-D <span style="border: 1px solid black; padding: 0 2px;">N</span>	4.2	0.17	22.0	0.87	23.2	0.92	17.0	0.67
	POM-LF <span style="border: 1px solid black; padding: 0 2px;">B</span>								
	PP <span style="border: 1px solid black; padding: 0 2px;">W</span>								

Non Standard material and color: See uni Material and Color Overview.

## Sprocket

No. of teeth	Bore size													Overall diameter		Pitch-diameter		Hub-diameter		Dimension A		Dimension B		Single row/Two way	Double row/Two way	Molded PA6 LG	Machined PA6 N
	Pilot Bore	in	0.75	0.78	0.98	1.00	1.18	1.25	1.50	1.57	2.36	2.50	3.54														
	mm	19.1	20.0	25.0	25.4	30.0	31.8	38.1	40.0	60.0	63.5	90.0	mm	in	mm	in	mm	in	mm	in							
Z06	x				●	●	●	■	■				94.5	3.72	100.3	3.95	65	2.56	35.5	1.40	58.6	2.31	x		x		
Z08	x				●	●	●	■	■				129	5.08	131.1	5.16	65	2.56	52.6	2.07	74	2.91	x		x		
Z10	x					●	●	■	■				160.1	6.30	162.4	6.39	65	2.56	69.2	2.72	89.7	3.53	x		x		
Z12	x					●	●	■	■				191.5	7.54	193.9	7.63	65	2.56	85.7	3.37	105.5	4.15	x		x		
Z13	x					●		■	■				207.3	8.16	209.7	8.26	72	2.83	93.8	3.69	113.4	4.46	x		x		
Z13													207.3	8.16	209.7	8.26	150	5.91	93.8	3.69	113.4	4.46	x			x	
Z16	x					●		■	■				254.8	10.03	257.3	10.13	200	7.87	118.2	4.65	137.1	5.40	x			x	

■ Molded sprocket

● Molded sprocket

■ Machined sprocket

● Machined sprocket

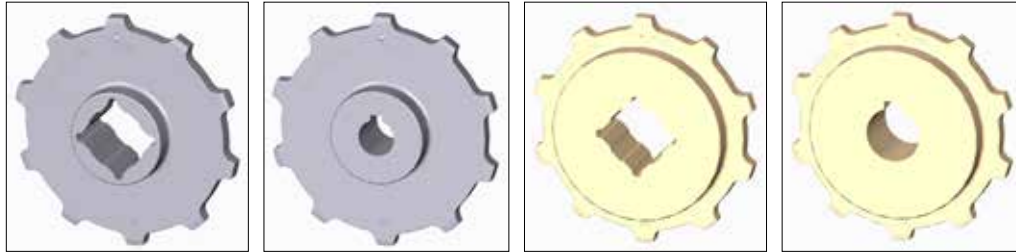

Non standard material and color: See uni Material and Color Overview.

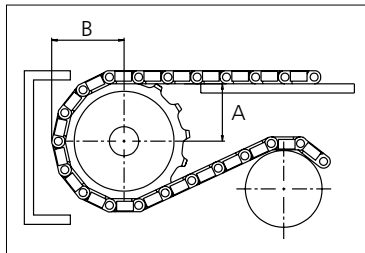

Other sprocket sizes are available upon request.  
 Two-part sprocket are available upon request.  
 Round bores are always delivered with keyway.  
 Other bore sizes are available upon request.  
 uni Retainer Rings: See uni Retainer Ring data sheet  
 Width of tooth = 11.0 mm (0.43 in)  
 Width of sprocket = 42.3 mm (1.67 in)

Max load per sprocket shown does not take bore size into account.  
 Please also ensure that sufficient size shaft is chosen for corresponding load.

For correct sprocket position: See uni Assembly Instructions for uni OPB.  
 For more detailed sprocket information, contact Customer Service.

uni OPB 8 20%/160707



Solid advice  
 For all your belting needs  
 Local stock & service  
[www.ammeraalbeltech.com](http://www.ammeraalbeltech.com)

**Ammeraal Beltech Modular A/S**  
 Hjulmagervej 21  
 DK-7100 Vejle

T +45 7572 3100  
 F +45 7572 3348  
 admin@unichains.com  
 www.unichains.com

This information is subject to alteration due to continuous development. Ammeraal Beltech will not be held liable for the incorrect use of the above stated information. This information replaces previous information. All activities performed and services rendered by Ammeraal Beltech are subject to general terms and conditions of sale and delivery, as applied by its operating companies.



# Plastic Modular Belt

Series **uni OPB 8** Type **25%**

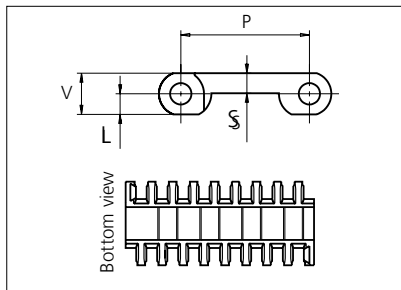

Straight running belt  
 Nominal pitch: 50.0 mm (1.97 in)  
 Surface type: Flat  
 Surface opening: 25%  
 Backflex radius: 75.0 mm (3.00 in)  
 Pin diameter: 8 mm (1.97 in)

\*uni-chains recommends this travel direction. However, travel in both directions is possible.

Recommended belt material & color	POM-D <b>W</b>		mm	in		mm	in
		<b>P (Nominal)</b>	50.0	1.97	<b>V</b>	16.0	0.63
Recommended pin and lock material & color	PP <b>W</b>						
		<b>L</b>	8.0	0.31	<b>S</b>	7.8	0.31

Non standard material and color: See uni Material and Color Overview.

Alternative materials: Belt: POM-LF, POM-SLF, PP, PE, PA6.6 and PA6.6H

Rodlock: PP **W**

Endlock: PP **W G B** and PE **W B**

Lockpin: PE **W** PA6.6 **N** PP **W**

Pin: PP **W** PE **W** SS304 and SS316

Belt width		Permissible tensile force (Belt/pin material)						Belt weight (Belt/pin material)						*Min. No. drive sprocket per shaft	Number of wear strips (Min. No.)	
		POM-D/PA6.6		PP/PA6.6		PE/PA6.6		POM-D/PA6.6		PP/PA6.6		PE/PA6.6			**Carry (pcs)	**Return (pcs)
mm	in	N	lbf	N	lbf	N	lbf	kg/m	lb/ft	kg/m	lb/ft	kg/m	lb/ft			
118	4.6	2596	584	1298	292	779	175	1.2	0.80	0.8	0.55	0.9	0.58	2	2	2
151	5.9	3322	747	1661	373	997	224	1.5	1.02	1.0	0.70	1.1	0.74	2	2	2
185	7.3	4070	915	2035	457	1221	274	1.9	1.26	1.3	0.86	1.4	0.91	2	2	2
302	11.9	6644	1494	3322	747	1993	448	3.1	2.05	2.1	1.40	2.2	1.48	3	3	2
453	17.8	9966	2240	4983	1120	2990	672	4.6	3.07	3.1	2.10	3.3	2.22	4	4	2
604	23.8	13288	2987	6644	1494	3986	896	6.1	4.10	4.2	2.80	4.4	2.96	5	5	3
755	29.7	16610	3734	8305	1867	4983	1120	7.6	5.12	5.2	3.50	5.5	3.70	6	6	3
906	35.7	19932	4481	9966	2240	5980	1344	9.2	6.15	6.3	4.20	6.6	4.44	7	7	4
1057	41.6	23254	5227	11627	2614	6976	1568	10.7	7.17	7.3	4.90	7.7	5.19	8	8	4
1208	47.6	26576	5974	13288	2987	7973	1792	12.2	8.20	8.3	5.60	8.8	5.93	9	9	5
1359	53.5	29898	6721	14949	3361	8969	2016	13.7	9.22	9.4	6.30	9.9	6.67	10	10	5
1510	59.4	33220	7468	16610	3734	9966	2240	15.3	10.25	10.4	7.00	11.0	7.41	11	11	6
1661	65.4	36542	8215	18271	4107	10963	2464	16.8	11.27	11.5	7.70	12.1	8.15	12	12	6

Additional standard belt widths are available in steps of 151.0 mm (5.94 in). Additional non-standard belt widths are available in steps of 33.6 mm (1.32 in).

2567	101.1	56474	12695	28237	6348	16942	3809	25.9	17.42	17.7	11.90	18.7	12.59	18	18	9
------	-------	-------	-------	-------	------	-------	------	------	-------	------	-------	------	-------	----	----	---

Additional standard belt widths are available in steps of 151.0 mm (5.94 in). Additional non-standard belt widths are available in steps of 33.6 mm (1.32 in).

2869	113.0	63118	14189	31559	7094	18935	4257	29.0	19.47	19.8	13.30	20.9	14.08	20	20	10
------	-------	-------	-------	-------	------	-------	------	------	-------	------	-------	------	-------	----	----	----

General belt tolerance is +0/-0.4% at 23°C/73°F and 50% RH. For exact belt width contact Customer Service. Non standard belt width on request.

\*Max. Load per Drive Sprocket. Belt material: POM 2500 N (562 lbf), PP 1200 N (270 lbf), PE 500 N (270 lbf)

\*\*Max. Spacing between wear strips, Carry: 152 mm (6 in); Return: 304 mm (12 in).

= Single Link



NON STANDARD

STRAIGHT RUNNING

PITCH 50.0 MM/1.97 IN

## Accessories

### Flight

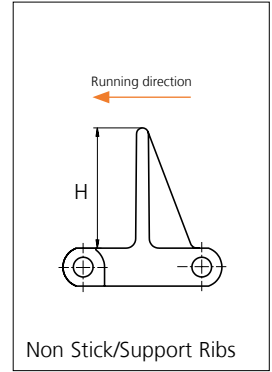
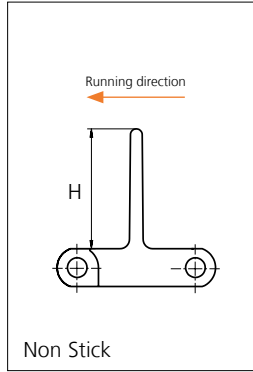

Type	Recommended Material & color	H		Link size	Width		Indent	
		mm	in		mm	in	mm	in
Non Stick	PP-HW <b>B</b>	50.8	2.00	K600	151.0	5.94	0.0	0.00
Non Stick/ Support Ribs		76.2	3.00					
		101.6	4.00					

Non Standard material and color: See uni Material and Color Overview.

## Accessories

### Side Guard

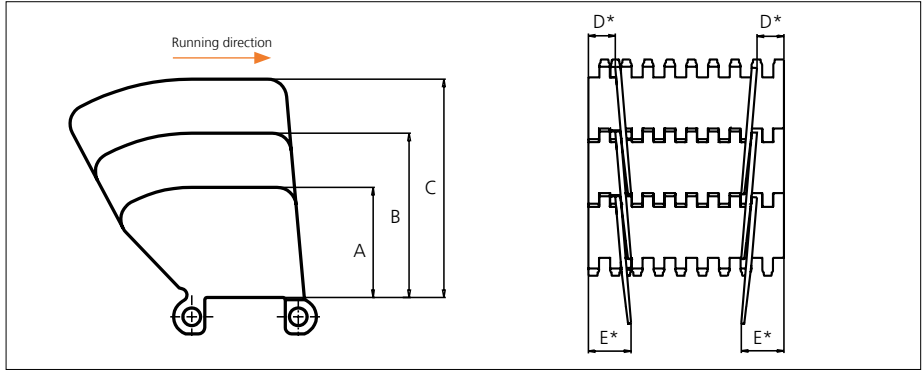

Type	Recommended Material & color	A		B		C		D*		E*	
		mm	in	mm	in	mm	in	mm	in	mm	in
Closed	PP-HW <b>B</b>	51.8	2.04	77.2	3.04	102.6	4.04	21.0	0.83	34.0	1.34

\* Min. indent Increment : 8.4 mm (0.33 in)

Note: Backflex radius when side guards are used: 200.0 mm (7.90 in)

Non Standard material and color: See uni Material and Color Overview.

## Accessories

### Tab

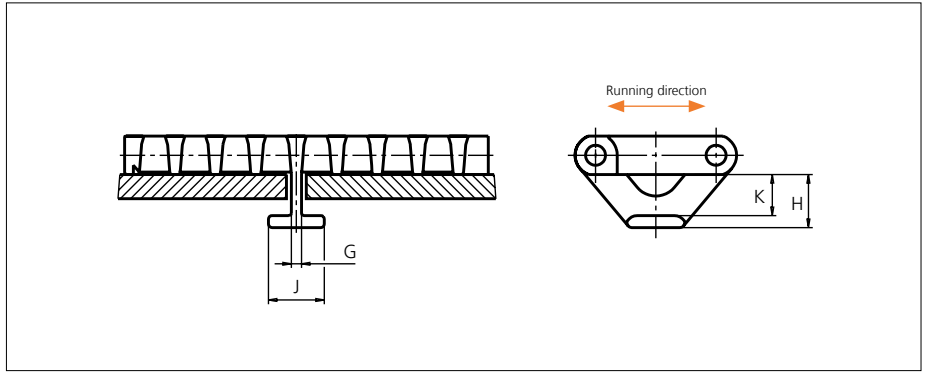

Type	Recommended material & color	G		H		J		K	
		mm	in	mm	in	mm	in	mm	in
Bottom Hold Down	POM-D <span style="border: 1px solid black; padding: 0 2px;">N</span>	4.2	0.17	22.0	0.87	23.2	0.92	17.0	0.67
	POM-LF <span style="border: 1px solid black; padding: 0 2px;">B</span>								
	PP <span style="border: 1px solid black; padding: 0 2px;">W</span>								

Non Standard material and color: See uni Material and Color Overview.

## Sprocket

No. of teeth	Bore size													Overall diameter		Pitch-diameter		Hub-diameter		Dimension A		Dimension B		Single row/Two way	Double row/Two way	Molded PA6 LG	Machined PA6 N
	Pilot Bore	in	0.75	0.78	0.98	1.00	1.18	1.25	1.50	1.57	2.36	2.50	3.54														
	mm	19.1	20.0	25.0	25.4	30.0	31.8	38.1	40.0	60.0	63.5	90.0	mm	in	mm	in	mm	in	mm	in							
Z06	x				●	●	●	■	■				94.5	3.72	100.3	3.95	65	2.56	35.5	1.40	58.6	2.31	x		x		
Z08	x				●	●	●	■	■				129	5.08	131.1	5.16	65	2.56	52.6	2.07	74	2.91	x		x		
Z10	x					●	●	■	■				160.1	6.30	162.4	6.39	65	2.56	69.2	2.72	89.7	3.53	x		x		
Z12	x					●	●	■	■				191.5	7.54	193.9	7.63	65	2.56	85.7	3.37	105.5	4.15	x		x		
Z13	x					●		■	■				207.3	8.16	209.7	8.26	72	2.83	93.8	3.69	113.4	4.46	x		x		
Z13											■		207.3	8.16	209.7	8.26	150	5.91	93.8	3.69	113.4	4.46	x			x	
Z16	x					●		■	■		■		254.8	10.03	257.3	10.13	200	7.87	118.2	4.65	137.1	5.40	x			x	

■ Molded sprocket

● Molded sprocket

■ Machined sprocket

● Machined sprocket

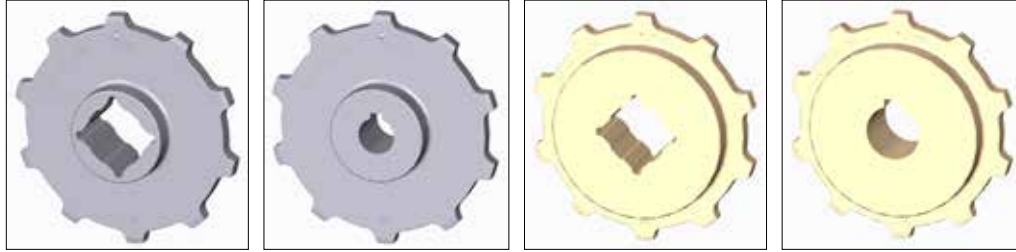

Non standard material and color: See uni Material and Color Overview.

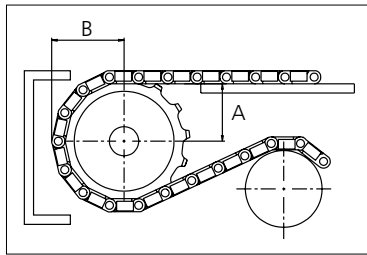

Other sprocket sizes are available upon request.  
 Two-part sprocket are available upon request.  
 Round bores are always delivered with keyway.  
 Other bore sizes are available upon request.  
 uni Retainer Rings: See uni Retainer Ring data sheet  
 Width of tooth = 11.0 mm (0.43 in)  
 Width of sprocket = 42.3 mm (1.67 in)

Max load per sprocket shown does not take bore size into account.  
 Please also ensure that sufficient size shaft is chosen for corresponding load.

For correct sprocket position: See uni Assembly Instructions for uni OPB.  
 For more detailed sprocket information, contact Customer Service.

uni OPB 8 25%/160707



Solid advice  
 For all your belting needs  
 Local stock & service  
[www.ammeraalbeltech.com](http://www.ammeraalbeltech.com)

**Ammeraal Beltech Modular A/S**  
 Hjulmagervej 21  
 DK-7100 Vejle

T +45 7572 3100  
 F +45 7572 3348  
 admin@unichains.com  
 www.unichains.com

This information is subject to alteration due to continuous development. Ammeraal Beltech will not be held liable for the incorrect use of the above stated information. This information replaces previous information. All activities performed and services rendered by Ammeraal Beltech are subject to general terms and conditions of sale and delivery, as applied by its operating companies.



# Plastic Modular Belt

Series **uni OPB 8** Type **C**

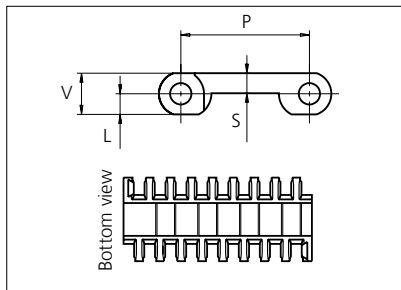

Straight running belt  
 Nominal pitch: 50.0 mm (1.97 in)  
 Surface type: Flat  
 Surface opening: Closed  
 Backflex radius: 75.0 mm (3.00 in)  
 Pin diameter: 8 mm (1.97 in)

\*uni-chains recommends this travel direction. However, travel in both directions is possible.

Recommended belt material & color	POM-D <b>W</b>		mm	in		mm	in
		<b>P (Nominal)</b>	50.0	1.97	<b>V</b>	16.0	0.63
Recommended pin and lock material & color	PP <b>W</b>						
		<b>L</b>	8.0	0.31	<b>S</b>	7.8	0.31

Non standard material and color: See uni Material and Color Overview.

Alternative materials: Belt: POM-LF, POM-SLF, PP, PE, PA6.6 and PA6.6H

Rodlock: PP **W**

Endlock: PP **W** **G** **B** and PE **W** **B**

Lockpin: PE **W** PA6.6 **N** PP **W**

Pin: PP **W** PE **W** SS304 and SS316

Belt width		Permissible tensile force (Belt/pin material)						Belt weight (Belt/pin material)						*Min. No. drive sprocket per shaft	Number of wear strips (Min. No.)	
		POM-D/PA6.6		PP/PA6.6		PE/PA6.6		POM-D/PA6.6		PP/PA6.6		PE/PA6.6			**Carry (pcs)	**Return (pcs)
mm	in	N	lbf	N	lbf	N	lbf	kg/m	lb/ft	kg/m	lb/ft	kg/m	lb/ft			
118	4.6	2596	584	1298	292	779	175	1.3	0.89	0.9	0.59	1.0	0.64	2	2	2
151	5.9	3322	747	1661	373	997	224	1.7	1.14	1.1	0.76	1.2	0.82	2	2	2
185	7.3	4070	915	2035	457	1221	274	2.1	1.39	1.4	0.93	1.5	1.01	2	2	2
302	11.9	6644	1494	3322	747	1993	448	3.4	2.27	2.3	1.52	2.4	1.64	3	3	2
453	17.8	9966	2240	4983	1120	2990	672	5.1	3.41	3.4	2.28	3.7	2.47	4	4	2
604	23.8	13288	2987	6644	1494	3986	896	6.8	4.55	4.5	3.04	4.9	3.29	5	5	3
755	29.7	16610	3734	8305	1867	4983	1120	8.5	5.68	5.7	3.81	6.1	4.11	6	6	3
906	35.7	19932	4481	9966	2240	5980	1344	10.1	6.82	6.8	4.57	7.3	4.93	7	7	4
1057	41.6	23254	5227	11627	2614	6976	1568	11.8	7.96	7.9	5.33	8.6	5.75	8	8	4
1208	47.6	26576	5974	13288	2987	7973	1792	13.5	9.09	9.1	6.09	9.8	6.58	9	9	5
1359	53.5	29898	6721	14949	3361	8969	2016	15.2	10.23	10.2	6.85	11.0	7.40	10	10	5
1510	59.4	33220	7468	16610	3734	9966	2240	16.9	11.37	11.3	7.61	12.2	8.22	11	11	6
1661	65.4	36542	8215	18271	4107	10963	2464	18.6	12.50	12.5	8.37	13.5	9.04	12	12	6

Additional standard belt widths are available in steps of 151.0 mm (5.94 in). Additional non-standard belt widths are available in steps of 33.6 mm (1.32 in).

2567	101.1	56474	12695	28237	6348	16942	3809	28.8	19.32	19.3	12.94	20.8	13.97	18	18	9
------	-------	-------	-------	-------	------	-------	------	------	-------	------	-------	------	-------	----	----	---

Additional standard belt widths are available in steps of 151.0 mm (5.94 in). Additional non-standard belt widths are available in steps of 33.6 mm (1.32 in).

2869	113.0	63118	14189	31559	7094	18935	4257	32.1	21.59	21.5	14.46	23.2	15.62	20	20	10
------	-------	-------	-------	-------	------	-------	------	------	-------	------	-------	------	-------	----	----	----

General belt tolerance is +0/-0.4% at 23°C/73°F and 50% RH. For exact belt width contact Customer Service. Non standard belt width on request.

\*Max. Load per Drive Sprocket. Belt material: POM 2500 N (562 lbf), PP 1200 N (270 lbf), PE 500 N (270 lbf)

\*\*Max. Spacing between wear strips, Carry: 152 mm (6 in); Return: 304 mm (12 in)

= Single Link



NON STANDARD

STRAIGHT RUNNING

PITCH 50.0 MM/1.97 IN

## Accessories

### Rubber Top

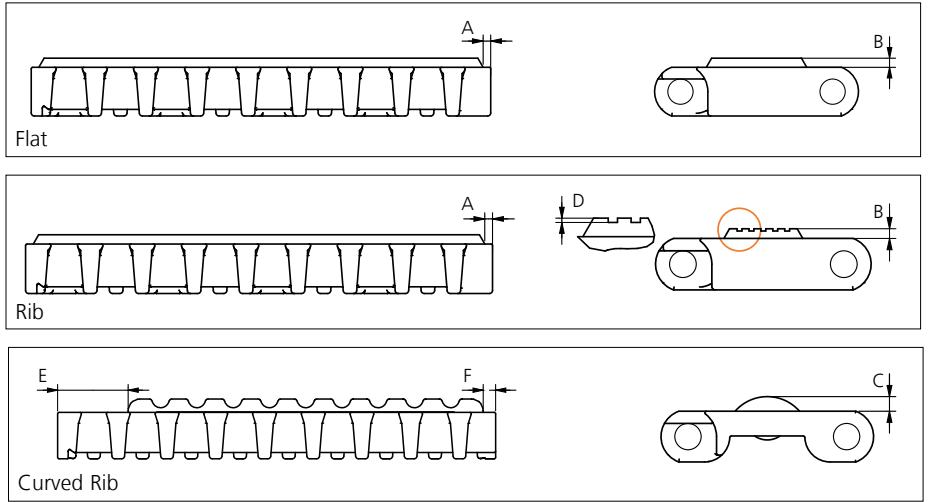

Type	Belt Material & color	Rubber Material & color	A		B		C		D		E		F		Link size	Width	
			mm	in	mm	in	mm	in	mm	in	mm	in	mm	in		mm	in
Flat	POM-LF <b>BR</b>	03 <b>N</b>															
Rib	POM-D <b>W</b>		2.5	0.10	3.0	0.12	4.5	0.18	0.7	0.03	24.0	0.94	4.0	0.16	K600	150.5	5.93
Curved Rib	POM-D <b>W</b>	03 <b>K</b>															

Other Non Standard Rubber profiles: See uni Rubber Profile Overview.

## Accessories

### Flight

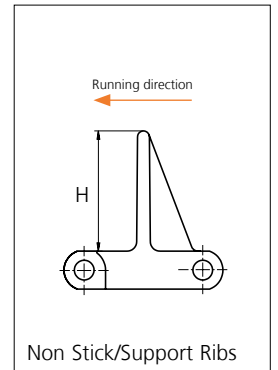
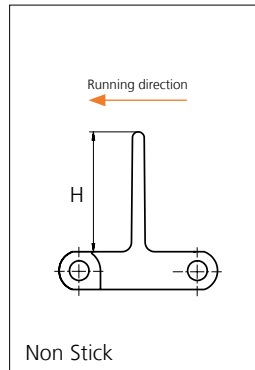

Type	Recommended Material & color	H		Link size	Width		Indent	
		mm	in		mm	in	mm	in
Non Stick	PP-HW <b>B</b>	50.8	2.00	K600	151.0	5.94	0.0	0.00
Non Stick/Support Ribs		76.2	3.00					
		101.6	4.00					

Non Standard material and color: See uni Material and Color Overview.



## Accessories

### Side Guard

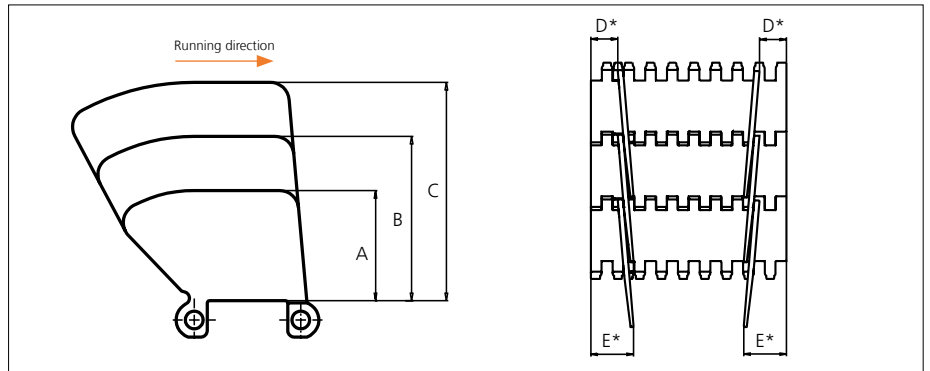

Type	Recommended Material & color	A		B		C		D*		E*	
		mm	in	mm	in	mm	in	mm	in	mm	in
Closed	PP-HW <b>B</b>	51.8	2.04	77.2	3.04	102.6	4.04	21.0	0.83	34.0	1.34

\* Min. indent Increment : 8.4 mm (0.33 in)

Note: Backflex radius when side guard are used: 200.0 mm (7.90 in)

Non Standard material and color: See uni Material and Color Overview.

## Accessories

### Tab

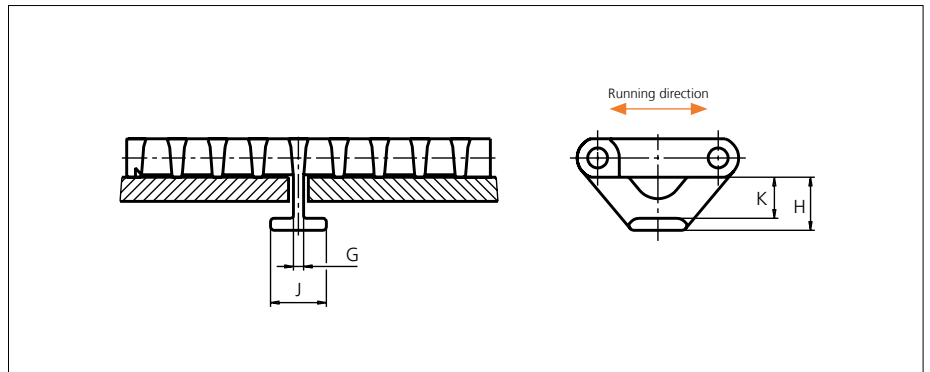

Type	Recommended material & color	G		H		J		K	
		mm	in	mm	in	mm	in	mm	in
Bottom Hold Down	POM-D <b>N</b>	4.2	0.17	22.0	0.87	23.2	0.92	17.0	0.67
	POM-LF <b>B</b>								
	PP <b>W</b>								

Non Standard material and color: See uni Material and Color Overview.

## Accessories

### Non Standard uni AmFlight

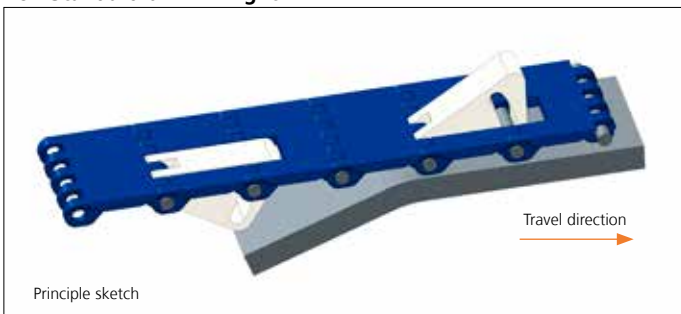

Other Non Standard option: See uni AmFlight Overview.

## Sprocket

No. of teeth	Bore size													Overall diameter		Pitch-diameter		Hub-diameter		Dimension A		Dimension B		Single row/Two way	Double row/Two way	Molded PA6 LG	Machined PA6 N
	Pilot Bore		0.75	0.78	0.98	1.00	1.18	1.25	1.50	1.57	2.36	2.50	3.54														
	mm	in	19.1	20.0	25.0	25.4	30.0	31.8	38.1	40.0	60.0	63.5	90.0	mm	in	mm	in	mm	in	mm	in						
Z06	x				●	●	●	■	■				94.5	3.72	100.3	3.95	65	2.56	35.5	1.40	58.6	2.31	x		x		
Z08	x				●	●	●	■	■				129	5.08	131.1	5.16	65	2.56	52.6	2.07	74	2.91	x		x		
Z10	x					●	●	■	■				160.1	6.30	162.4	6.39	65	2.56	69.2	2.72	89.7	3.53	x		x		
Z12	x					●	●	■	■				191.5	7.54	193.9	7.63	65	2.56	85.7	3.37	105.5	4.15	x		x		
Z13	x					●		■	■				207.3	8.16	209.7	8.26	72	2.83	93.8	3.69	113.4	4.46	x		x		
Z13											■		207.3	8.16	209.7	8.26	150	5.91	93.8	3.69	113.4	4.46	x			x	
Z16	x					●		■	■			■	254.8	10.03	257.3	10.13	200	7.87	118.2	4.65	137.1	5.40	x			x	

■ Molded sprocket

● Molded sprocket

■ Machined sprocket

● Machined sprocket

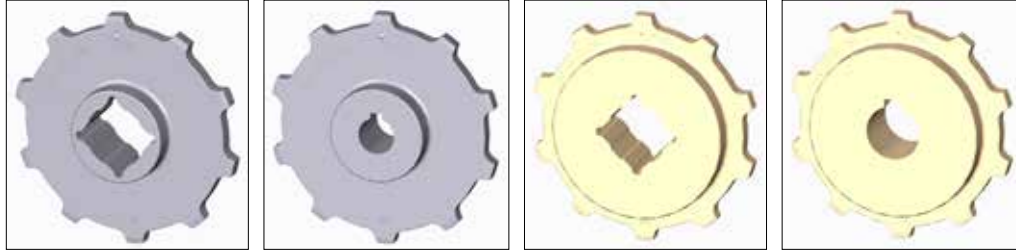

Non standard material and color: See uni Material and Color Overview.

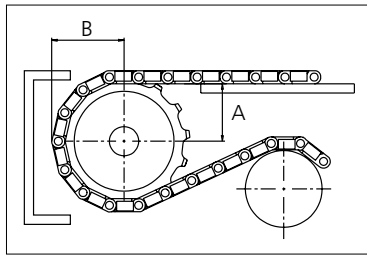

Other sprocket sizes are available upon request.  
 Two-part sprocket are available upon request.  
 Round bores are always delivered with keyway.  
 Other bore sizes are available upon request.  
 uni Retainer Rings: See uni Retainer Ring data sheet  
 Width of tooth = 11.0 mm (0.43 in)  
 Width of sprocket = 42.3 mm (1.67 in)

Max load per sprocket shown does not take bore size into account.  
 Please also ensure that sufficient size shaft is chosen for corresponding load.

For correct sprocket position: See uni Assembly Instructions for uni OPB.  
 For more detailed sprocket information, contact Customer Service.

uni OPB 8 C/160707



Solid advice  
 For all your belting needs  
 Local stock & service  
[www.ammeraalbeltech.com](http://www.ammeraalbeltech.com)

**Ammeraal Beltech Modular A/S**  
 Hjulmagervej 21  
 DK-7100 Vejle

T +45 7572 3100  
 F +45 7572 3348  
 admin@unichains.com  
 www.unichains.com

This information is subject to alteration due to continuous development. Ammeraal Beltech will not be held liable for the incorrect use of the above stated information. This information replaces previous information. All activities performed and services rendered by Ammeraal Beltech are subject to general terms and conditions of sale and delivery, as applied by its operating companies.



# Plastic Modular Belt

Series **uni OPB 8M** Type **C**

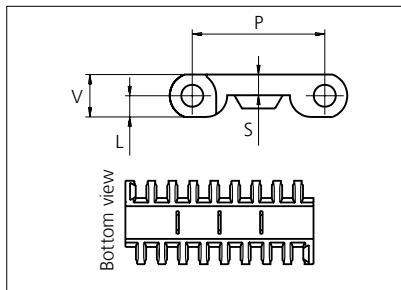

Straight running belt  
 Nominal pitch: 50.0 mm (1.97 in)  
 Surface type: Flat  
 Surface opening: Closed  
 Backflex radius: 75.0 mm (3.00 in)  
 Pin diameter: 8 mm (1.97 in)

\*uni-chains recommends this travel direction. However, travel in both directions is possible.

Recommended belt material & color	POM-D <b>W</b>		mm	in		mm	in
		<b>P (Nominal)</b>	50.0	1.97	<b>V</b>	16.0	0.63
Recommended pin and lock material & color	PP <b>W</b>						
		<b>L</b>	8.0	0.31	<b>S</b>	7.8	0.31

Non standard material and color: See uni Material and Color Overview.

Alternative materials: Belt: POM-LF, POM-SLF, PP, PE, PA6.6 and PA6.6H

Rodlock: PP **W**

Endlock: PP **W** **G** **B** and PE **W** **B**

Lockpin: PE **W** PA6.6 **N** PP **W**

Pin: PP **W** PE **W** SS304 and SS316

Belt width		Permissible tensile force (Belt/pin material)						Belt weight (Belt/pin material)						*Min. No. drive sprocket per shaft	Number of wear strips (Min. No.)	
		POM-D/PA6.6		PP/PA6.6		PE/PA6.6		POM-D/PA6.6		PP/PA6.6		PE/PA6.6			**Carry (pcs)	**Return (pcs)
mm	in	N	lbf	N	lbf	N	lbf	kg/m	lb/ft	kg/m	lb/ft	kg/m	lb/ft			
151	5.9	3322	747	1661	373	997	224	1.8	1.19	1.1	0.76	1.2	0.82	2	2	2
185	7.3	4070	915	2035	457	1221	274	2.2	1.45	1.4	0.93	1.5	1.01	2	2	2
302	11.9	6644	1494	3322	747	1993	448	3.5	2.37	2.3	1.52	2.4	1.64	3	3	2
453	17.8	9966	2240	4983	1120	2990	672	5.3	3.56	3.4	2.28	3.7	2.47	4	4	2
604	23.8	13288	2987	6644	1494	3986	896	7.1	4.75	4.5	3.04	4.9	3.29	5	5	3
755	29.7	16610	3734	8305	1867	4983	1120	8.8	5.94	5.7	3.81	6.1	4.11	6	6	3
906	35.7	19932	4481	9966	2240	5980	1344	10.6	7.12	6.8	4.57	7.3	4.93	7	7	4
1057	41.6	23254	5227	11627	2614	6976	1568	12.4	8.31	7.9	5.33	8.6	5.75	8	8	4
1208	47.6	26576	5974	13288	2987	7973	1792	14.1	9.50	9.1	6.09	9.8	6.58	9	9	5
1359	53.5	29898	6721	14949	3361	8969	2016	15.9	10.69	10.2	6.85	11.0	7.40	10	10	5
1510	59.4	33220	7468	16610	3734	9966	2240	17.7	11.87	11.3	7.61	12.2	8.22	11	11	6
1661	65.4	36542	8215	18271	4107	10963	2464	19.4	13.06	12.5	8.37	13.5	9.04	12	12	6
1812	71.3	39864	8961	19932	4481	11959	2688	21.2	14.25	13.6	9.13	14.7	9.86	13	13	7

Additional standard belt widths are available in steps of 151.0 mm (5.94 in). Additional non-standard belt widths are available in steps of 33.6 mm (1.32 in).

2567	101.1	56474	12695	28237	6348	16942	3809	30.0	20.18	19.3	12.94	20.8	13.97	18	18	9
------	-------	-------	-------	-------	------	-------	------	------	-------	------	-------	------	-------	----	----	---

Additional standard belt widths are available in steps of 151.0 mm (5.94 in). Additional non-standard belt widths are available in steps of 33.6 mm (1.32 in).

2869	113.0	63118	14189	31559	7094	18935	4257	33.6	22.56	21.5	14.46	23.2	15.62	20	20	10
------	-------	-------	-------	-------	------	-------	------	------	-------	------	-------	------	-------	----	----	----

General belt tolerance is +0/-0.4% at 23°C/73°F and 50% RH. For exact belt width contact Customer Service. Non standard belt width on request.

\*Max. Load per Drive Sprocket. Belt material: POM 2500 N (562 lbf), PP 1200 N (270 lbf), PE 500 N (270 lbf).

\*\*Max. Spacing between wear strips, Carry: 152 mm (6 in); Return: 304 mm (12 in).

= Single Link



NON STANDARD

STRAIGHT RUNNING

PITCH 50.0 MM/1.97 IN

## Accessories

### Rubber Top

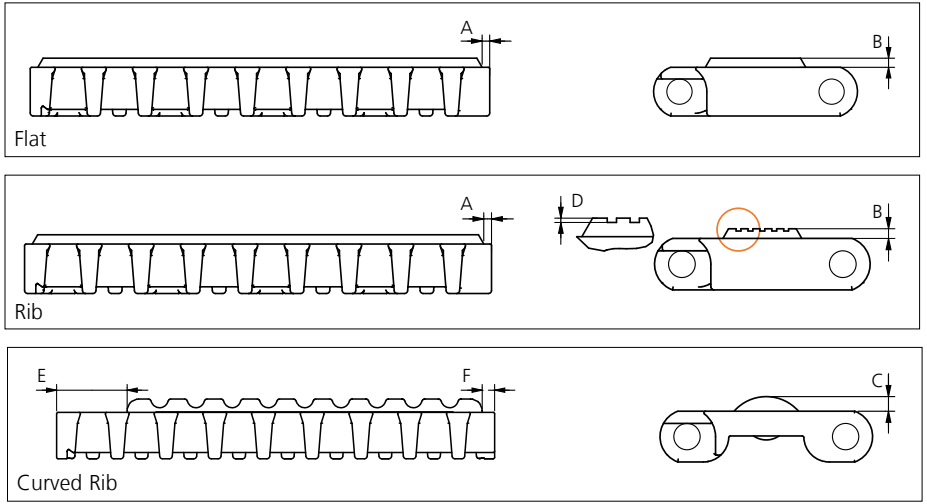

Type	Belt Material & color	Rubber Material & color	A		B		C		D		E		F		Link size	Width	
			mm	in	mm	in	mm	in	mm	in	mm	in	mm	in		mm	in
Flat	POM-LF <b>BR</b>	03 <b>N</b>															
Rib	POM-D <b>W</b>		2.5	0.10	3.0	0.12	4.5	0.18	0.7	0.03	24.0	0.94	4.0	0.16	K600	150.5	5.93
Curved Rib	POM-D <b>W</b>	03 <b>K</b>															

Other Non Standard Rubber profiles: See uni Rubber Profile Overview.

## Accessories

### Flight

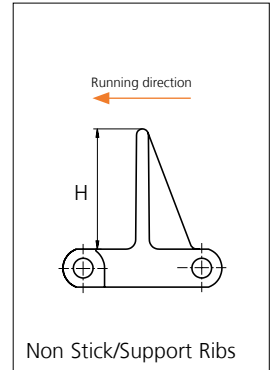
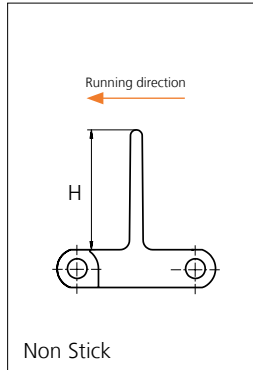

Type	Recommended Material & color	H		Link size	Width		Indent	
		mm	in		mm	in	mm	in
Non Stick	PP-HW <b>B</b>	50.8	2.00	K600	151.0	5.94	0.0	0.00
Non Stick/Support Ribs		76.2	3.00					
		101.6	4.00					

Non Standard material and color: See uni Material and Color Overview.

## Accessories

### Side Guard

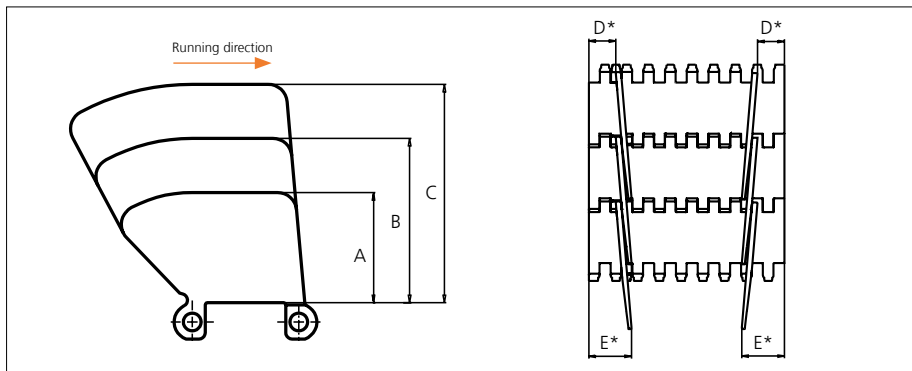

Type	Recommended Material & color	A		B		C		D*		E*	
		mm	in	mm	in	mm	in	mm	in	mm	in
Closed	PP-HW <b>B</b>	51.8	2.04	77.2	3.04	102.6	4.04	21.0	0.83	34.0	1.34

\* Min. indent Increment : 8.4 mm (0.33 in)

Note: Backflex radius when side guard are used: 200.0 mm (7.90 in)

Non Standard material and color: See uni Material and Color Overview.

## Accessories

### Tab

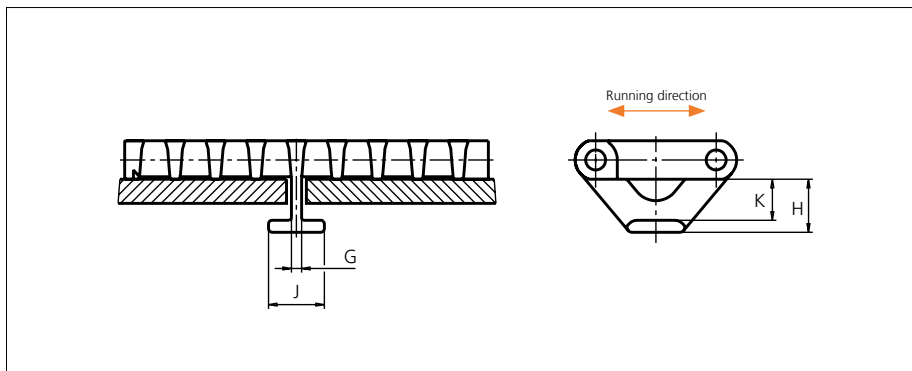

Type	Recommended Material & color	G		H		J		K	
		mm	in	mm	in	mm	in	mm	in
Bottom Hold Down	POM-D <b>N</b>	4.2	0.17	22.0	0.87	23.2	0.92	17.0	0.67
	POM-LF <b>B</b>								
	PP <b>W</b>								

Non Standard material and color: See uni Material and Color Overview.

## Accessories

### Non Standard uni AmFlight

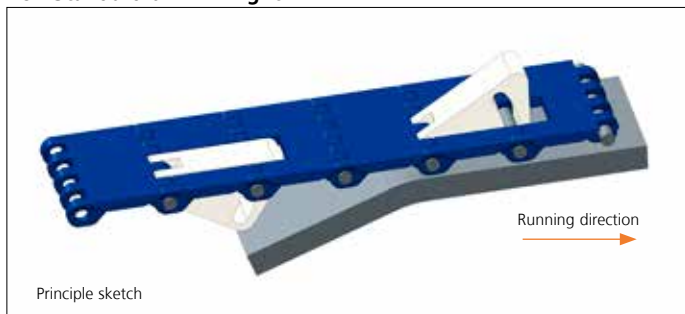

Other Non Standard option: See uni AmFlight Overview.

## Sprocket

No. of teeth	Bore size													Overall diameter		Pitch-diameter		Hub-diameter		Dimension A		Dimension B		Single row/Two way	Double row/Two way	Molded PA6 LG	Machined PA6 N
	Pilot Bore	in	0.75	0.78	0.98	1.00	1.18	1.25	1.50	1.57	2.36	2.50	3.54														
	mm	19.1	20.0	25.0	25.4	30.0	31.8	38.1	40.0	60.0	63.5	90.0	mm	in	mm	in	mm	in	mm	in							
Z06	x				●	●	●	■	■				89.1	3.51	100.3	3.95	65	2.56	35.5	1.40	58.6	2.31	x		x		
Z08	x				●	●	●	■	■				120.9	4.76	131.1	5.16	65	2.56	52.6	2.07	74	2.91	x		x		
Z10	x					●	●	■	■				153.0	6.02	162.4	6.39	65	2.56	69.2	2.72	89.7	3.53	x		x		
Z12	x					●	●	■	■				185.5	7.30	193.9	7.63	65	2.56	85.7	3.37	105.5	4.15	x		x		
Z13	x					●		■	■				201.0	7.91	209.7	8.26	72	2.83	93.8	3.69	113.4	4.46	x		x		
Z13											■		201.0	7.91	209.7	8.26	150	5.91	93.8	3.69	113.4	4.46	x			x	
Z16	x					●		■	■		■		250.8	9.87	257.3	10.13	200	7.87	118.2	4.65	137.1	5.40	x			x	

■ Molded sprocket

● Molded sprocket

■ Machined sprocket

● Machined sprocket

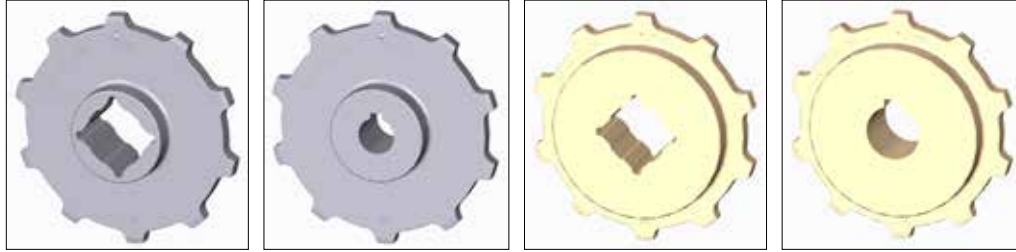

Non standard material and color: See uni Material and Color Overview.

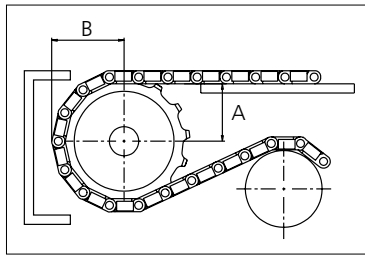

Other sprocket sizes are available upon request.  
 Two-part sprocket are available upon request.  
 Round bores are always delivered with keyway.  
 Other bore sizes are available upon request.  
 uni Retainer Rings: See uni Retainer Ring data sheet  
 Width of tooth = 11.0 mm (0.43 in)  
 Width of sprocket = 42.3 mm (1.67 in)

Max load per sprocket shown does not take bore size into account.  
 Please also ensure that sufficient size shaft is chosen for corresponding load.

For correct sprocket position: See uni Assembly Instructions for uni OPB.  
 For more detailed sprocket information, contact Customer Service.

uni OPB 8M C/160707



Solid advice  
 For all your belting needs  
 Local stock & service  
[www.ammeraalbeltech.com](http://www.ammeraalbeltech.com)

**Ammeraal Beltech Modular A/S**  
 Hjulmagervej 21  
 DK-7100 Vejle

T +45 7572 3100  
 F +45 7572 3348  
 admin@unichains.com  
 www.unichains.com

This information is subject to alteration due to continuous development. Ammeraal Beltech will not be held liable for the incorrect use of the above stated information. This information replaces previous information. All activities performed and services rendered by Ammeraal Beltech are subject to general terms and conditions of sale and delivery, as applied by its operating companies.



# Plastic Modular Belt

Series **uni OPB 8P** Type **C**

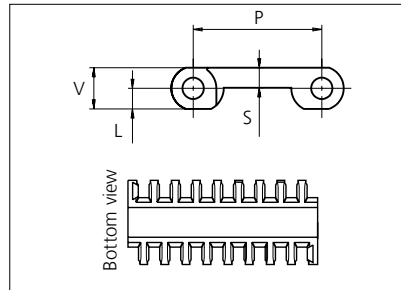

Straight running belt  
 Nominal pitch: 50.0 mm (1.97 in)  
 Surface type: Flat  
 Surface opening: Closed  
 Backflex radius: 75.0 mm (3.00 in)  
 Pin diameter: 8 mm (1.97 in)

\*uni-chains recommends this travel direction. However, travel in both directions is possible.

Recommended belt material & color	POM-D <b>W</b>		mm	in		mm	in
		<b>P (Nominal)</b>	50.0	1.97	<b>V</b>	16.0	0.63
Recommended pin and lock material & color	PP <b>W</b>						
		<b>L</b>	8.0	0.31	<b>S</b>	7.8	0.31

Non standard material and color: See uni Material and Color Overview.

Alternative materials: Belt: POM-LF, POM-SLF, PP, PE, PA6.6 and PA6.6H

Rodlock: PP **W**

Endlock: PP **W G B** and PE **W B**

Lockpin: PE **W** PA6.6 **N** PP **W**

Pin: PP **W** PE **W** SS304 and SS316

Belt width		Permissible tensile force (Belt/pin material)						Belt weight (Belt/pin material)						*Min. No. drive sprocket per shaft	Number of wear strips (Min. No.)	
		POM-D/PA6.6		PP/PA6.6		PE/PA6.6		POM-D/PA6.6		PP/PA6.6		PE/PA6.6			**Carry (pcs)	**Return (pcs)
mm	in	N	lbf	N	lbf	N	lbf	kg/m	lb/ft	kg/m	lb/ft	kg/m	lb/ft			
151	5.9	3322	747	1661	373	997	224	1.8	1.19	1.1	0.76	1.2	0.82	2	2	2
185	7.3	4070	915	2035	457	1221	274	2.2	1.45	1.4	0.93	1.5	1.01	2	2	2
302	11.9	6644	1494	3322	747	1993	448	3.5	2.37	2.3	1.52	2.4	1.64	3	3	2
453	17.8	9966	2240	4983	1120	2990	672	5.3	3.56	3.4	2.28	3.7	2.47	4	4	2
604	23.8	13288	2987	6644	1494	3986	896	7.1	4.75	4.5	3.04	4.9	3.29	5	5	3
755	29.7	16610	3734	8305	1867	4983	1120	8.8	5.94	5.7	3.81	6.1	4.11	6	6	3
906	35.7	19932	4481	9966	2240	5980	1344	10.6	7.12	6.8	4.57	7.3	4.93	7	7	4
1057	41.6	23254	5227	11627	2614	6976	1568	12.4	8.31	7.9	5.33	8.6	5.75	8	8	4
1208	47.6	26576	5974	13288	2987	7973	1792	14.1	9.50	9.1	6.09	9.8	6.58	9	9	5
1359	53.5	29898	6721	14949	3361	8969	2016	15.9	10.69	10.2	6.85	11.0	7.40	10	10	5
1510	59.4	33220	7468	16610	3734	9966	2240	17.7	11.87	11.3	7.61	12.2	8.22	11	11	6
1661	65.4	36542	8215	18271	4107	10963	2464	19.4	13.06	12.5	8.37	13.5	9.04	12	12	6
1812	71.3	39864	8961	19932	4481	11959	2688	21.2	14.25	13.6	9.13	14.7	9.86	13	13	7

Additional standard belt widths are available in steps of 151.0 mm (5.94 in). Additional non-standard belt widths are available in steps of 33.6 mm (1.32 in).

2567	101.1	56474	12695	28237	6348	16942	3809	30.0	20.18	19.3	12.94	20.8	13.97	18	18	9
------	-------	-------	-------	-------	------	-------	------	------	-------	------	-------	------	-------	----	----	---

Additional standard belt widths are available in steps of 151.0 mm (5.94 in). Additional non-standard belt widths are available in steps of 33.6 mm (1.32 in).

2869	113.0	63118	14189	31559	7094	18935	4257	33.6	22.56	21.5	14.46	23.2	15.62	20	20	10
------	-------	-------	-------	-------	------	-------	------	------	-------	------	-------	------	-------	----	----	----

General belt tolerance is +0/-0.4% at 23°C/73°F and 50% RH. For exact belt width contact Customer Service. Non standard belt width on request.

\*Max. Load per Drive Sprocket. Belt material: POM 2500 N (562 lbf), PP 1200 N (270 lbf), PE 500 N (270 lbf).

\*\*Max. Spacing between wear strips, Carry: 152 mm (6 in); Return: 304 mm (12 in).

= Single Link



NON STANDARD

STRAIGHT RUNNING

PITCH 50.0 MM/1.97 IN

## Accessories

### Rubber Top

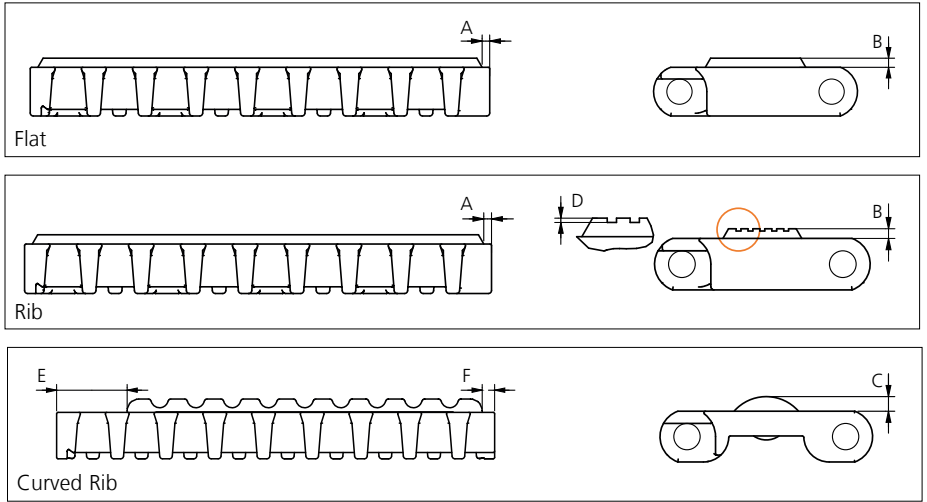

Type	Belt Material & color	Rubber Material & color	A		B		C		D		E		F		Link size	Width	
			mm	in	mm	in	mm	in	mm	in	mm	in	mm	in			
Flat	POM-LF <b>BR</b>	03 <b>N</b>															
Rib	POM-D <b>W</b>		2.5	0.10	3.0	0.12	4.5	0.18	0.7	0.03	24.0	0.94	4.0	0.16	K600	150.5	5.93
Curved Rib	POM-D <b>W</b>	03 <b>K</b>															

Other Non Standard Rubber profiles: See uni Rubber Profile Overview.

## Accessories

### Flight

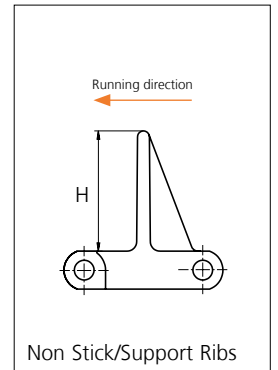
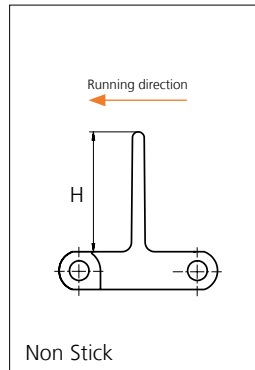

Type	Recommended Material & color	H		Link size	Width		Indent	
		mm	in		mm	in	mm	in
Non Stick	PP-HW <b>B</b>	50.8	2.00	K600	151.0	5.94	0.0	0.00
Non Stick/Support Ribs		76.2	3.00					
		101.6	4.00					

Non Standard material and color: See uni Material and Color Overview.



## Accessories

### Side Guard

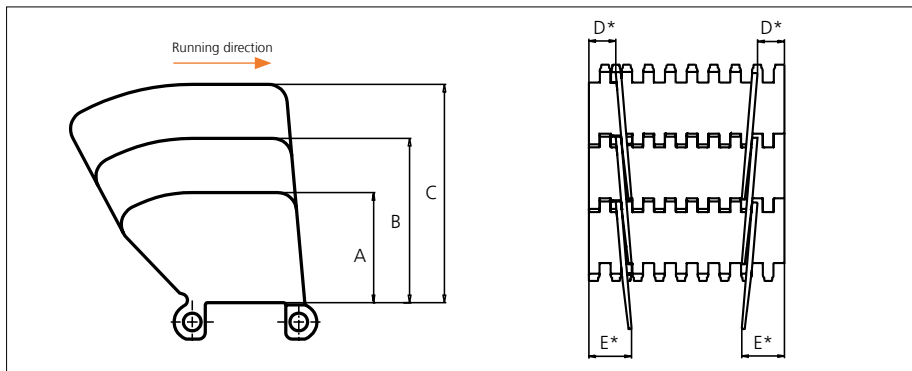

Type	Recommended Material & color	A		B		C		D*		E*	
		mm	in	mm	in	mm	in	mm	in	mm	in
Closed	PP-HW <b>B</b>	51.8	2.04	77.2	3.04	102.6	4.04	21.0	0.83	34.0	1.34

\* Min. indent Increment : 8.4 mm (0.33 in)

Note: Backflex radius when side guard are used: 200.0 mm (7.90 in)

Non Standard material and color: See uni Material and Color Overview.

## Accessories

### Tab

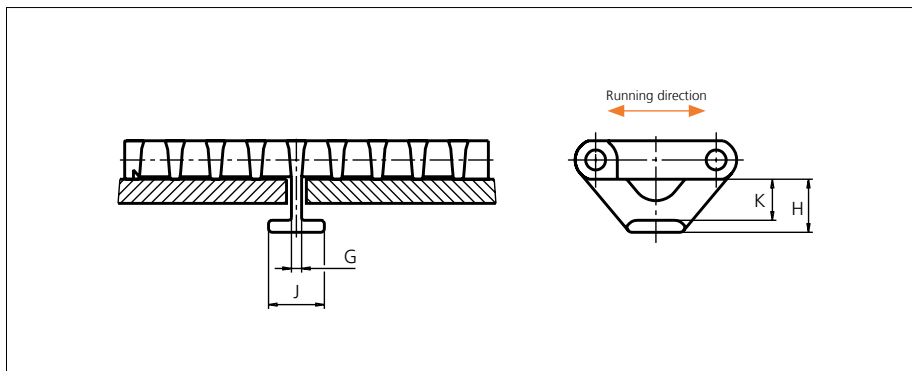

Type	Recommended Material & color	G		H		J		K	
		mm	in	mm	in	mm	in	mm	in
Bottom Hold Down	POM-D <b>N</b>	4.2	0.17	22.0	0.87	23.2	0.92	17.0	0.67
	POM-LF <b>B</b>								
	PP <b>W</b>								

Non Standard material and color: See uni Material and Color Overview.

## Accessories

### Non Standard uni AmFlight

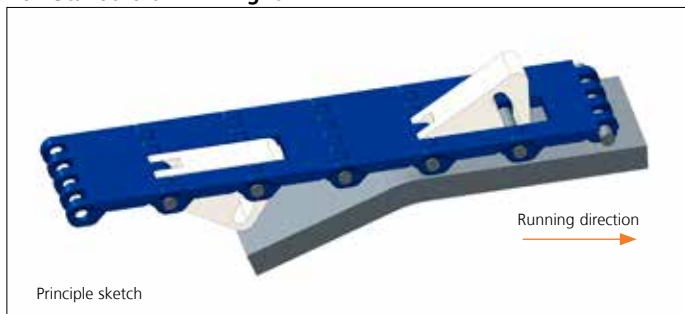

Other Non Standard option: See uni AmFlight Overview.

## Sprocket

No of teeth	Bore size													Overall diameter		Pitch-diameter		Hub-diameter		Dimension A		Dimension B		Single row/Two way	Double row/Two way	Molded PA6 LG	Machined PA6 N
	Pilot Bore	in	0.75	0.78	0.98	1.00	1.18	1.25	1.50	1.57	2.36	2.50	3.54														
	mm	19.1	20.0	25.0	25.4	30.0	31.8	38.1	40.0	60.0	63.5	90.0	mm	in	mm	in	mm	in	mm	in							
Z06	x				●	●	●	■	■				89.1	3.51	100.3	3.95	65	2.56	35.5	1.40	58.6	2.31	x		x		
Z08	x				●	●	●	■	■				120.9	4.76	131.1	5.16	65	2.56	52.6	2.07	74	2.91	x		x		
Z10	x					●	●	■	■				153.0	6.02	162.4	6.39	65	2.56	69.2	2.72	89.7	3.53	x		x		
Z12	x					●	●	■	■				185.5	7.30	193.9	7.63	65	2.56	85.7	3.37	105.5	4.15	x		x		
Z13	x					●		■	■				201.0	7.91	209.7	8.26	72	2.83	93.8	3.69	113.4	4.46	x		x		
Z13													201.0	7.91	209.7	8.26	150	5.91	93.8	3.69	113.4	4.46	x			x	
Z16	x					●		■	■				250.8	9.87	257.3	10.13	200	7.87	118.2	4.65	137.1	5.40	x			x	

■ Molded sprocket

● Molded sprocket

■ Machined sprocket

● Machined sprocket

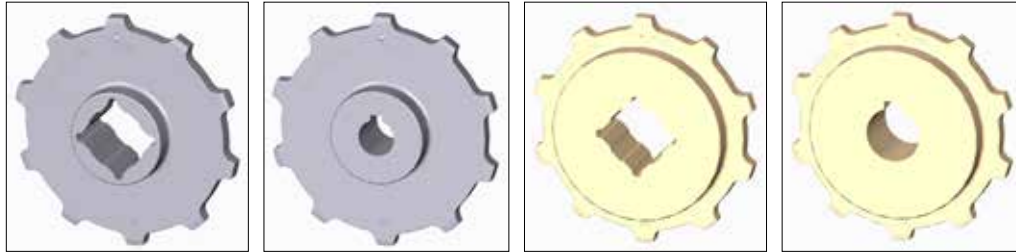

Non standard material and color: See uni Material and Color Overview.

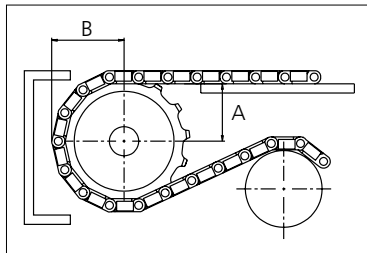

Other sprocket sizes are available upon request.  
 Two-part sprocket are available upon request.  
 Round bores are always delivered with keyway.  
 Other bore sizes are available upon request.  
 uni Retainer Rings: See uni Retainer Ring data sheet  
 Width of tooth = 11.0 mm (0.43 in)  
 Width of sprocket = 42.3 mm (1.67 in)

Max load per sprocket shown does not take bore size into account.  
 Please also ensure that sufficient size shaft is chosen for corresponding load.

For correct sprocket position: See uni Assembly Instructions for uni OPB.  
 For more detailed sprocket information, contact Customer Service.

uni OPB 8P C/160707



Solid advice  
 For all your belting needs  
 Local stock & service  
[www.ammeraalbeltech.com](http://www.ammeraalbeltech.com)

**Ammeraal Beltech Modular A/S**  
 Hjulmagervej 21  
 DK-7100 Vejle

T +45 7572 3100  
 F +45 7572 3348  
 admin@unichains.com  
 www.unichains.com

This information is subject to alteration due to continuous development. Ammeraal Beltech will not be held liable for the incorrect use of the above stated information. This information replaces previous information. All activities performed and services rendered by Ammeraal Beltech are subject to general terms and conditions of sale and delivery, as applied by its operating companies.



# Plastic Modular Belt

Series **uni OPB 8** Type **Rough**

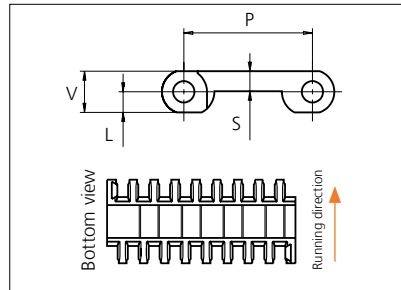

Straight running belt  
 Nominal pitch: 50.0 mm (1.97 in)  
 Surface type: Rough  
 Surface opening: Closed  
 Backflex radius: 75.0 mm (3.00 in)  
 Pin diameter: 8 mm (1.97 in)

\*uni-chains recommends this travel direction. However, travel in both directions is possible.

Recommended belt material & color	POM-D <b>W</b>		mm	in		mm	in
		<b>P (Nominal)</b>	50.0	1.97	<b>V</b>	16.0	0.63
Recommended pin and lock material & color	PP <b>W</b>						
		<b>L</b>	8.0	0.31	<b>S</b>	7.8	0.31

Non standard material and color: See uni Material and Color Overview.

Alternative materials: Belt: POM-LF, POM-SLF, PP, PE, PA6.6 and PA6.6H

Rodlock: PP **W**

Endlock: PP **W** **G** **B** and PE **W** **B**

Lockpin: PE **W** PA6.6 **N** PP **W**

Pin: PP **W** PE **W** SS304 and SS316

Belt width		Permissible tensile force (Belt/pin material)						Belt weight (Belt/pin material)						*Min. No. drive sprocket per shaft	Number of wear strips (Min. No.)	
		POM-D/PA6.6		PP/PA6.6		PE/PA6.6		POM-D/PA6.6		PP/PA6.6		PE/PA6.6			**Carry (pcs)	**Return (pcs)
mm	in	N	lbf	N	lbf	N	lbf	kg/m	lb/ft	kg/m	lb/ft	kg/m	lb/ft			
151	5.9	3322	747	1661	373	997	224	1.8	1.19	1.1	0.76	1.2	0.82	2	2	2
302	11.9	6644	1494	3322	747	1993	448	3.5	2.37	2.3	1.52	2.4	1.64	3	3	2
453	17.8	9966	2240	4983	1120	2990	672	5.3	3.56	3.4	2.28	3.7	2.47	4	4	2
604	23.8	13288	2987	6644	1494	3986	896	7.1	4.75	4.5	3.04	4.9	3.29	5	5	3
755	29.7	16610	3734	8305	1867	4983	1120	8.8	5.94	5.7	3.81	6.1	4.11	6	6	3
906	35.7	19932	4481	9966	2240	5980	1344	10.6	7.12	6.8	4.57	7.3	4.93	7	7	4
1057	41.6	23254	5227	11627	2614	6976	1568	12.4	8.31	7.9	5.33	8.6	5.75	8	8	4
1208	47.6	26576	5974	13288	2987	7973	1792	14.1	9.50	9.1	6.09	9.8	6.58	9	9	5
1359	53.5	29898	6721	14949	3361	8969	2016	15.9	10.69	10.2	6.85	11.0	7.40	10	10	5
1510	59.4	33220	7468	16610	3734	9966	2240	17.7	11.87	11.3	7.61	12.2	8.22	11	11	6
1661	65.4	36542	8215	18271	4107	10963	2464	19.4	13.06	12.5	8.37	13.5	9.04	12	12	6
1812	71.3	39864	8961	19932	4481	11959	2688	21.2	14.25	13.6	9.13	14.7	9.86	13	13	7
1963	77.3	43186	9708	21593	4854	12956	2912	23.0	15.44	14.7	9.89	15.9	10.69	14	14	7

Additional standard belt widths are available in steps of 151.0 mm (5.94 in). Additional non-standard belt widths are available in steps of 33.6 mm (1.32 in).

2567	101.1	56474	12695	28237	6348	16942	3809	30.0	20.18	19.3	12.94	20.8	13.97	18	18	9
------	-------	-------	-------	-------	------	-------	------	------	-------	------	-------	------	-------	----	----	---

Additional standard belt widths are available in steps of 151.0 mm (5.94 in). Additional non-standard belt widths are available in steps of 33.6 mm (1.32 in).

2869	113.0	63118	14189	31559	7094	18935	4257	33.6	22.56	21.5	14.46	23.2	15.62	20	20	10
------	-------	-------	-------	-------	------	-------	------	------	-------	------	-------	------	-------	----	----	----

General belt tolerance is +0/-0.4% at 23°C/73°F and 50% RH. For exact belt width contact Customer Service. Non standard belt width on request.

\*Max. Load per Drive Sprocket. Belt material: POM 2500 N (562 lbf), PP 1200 N (270 lbf), PE 500 N (270 lbf)

\*\*Max. Spacing between wear strips, Carry: 152 mm (6 in); Return: 304 mm (12 in)

= Single Link



NON STANDARD

STRAIGHT RUNNING

PITCH 50.0 MM/1.97 IN

## Accessories

### Tab

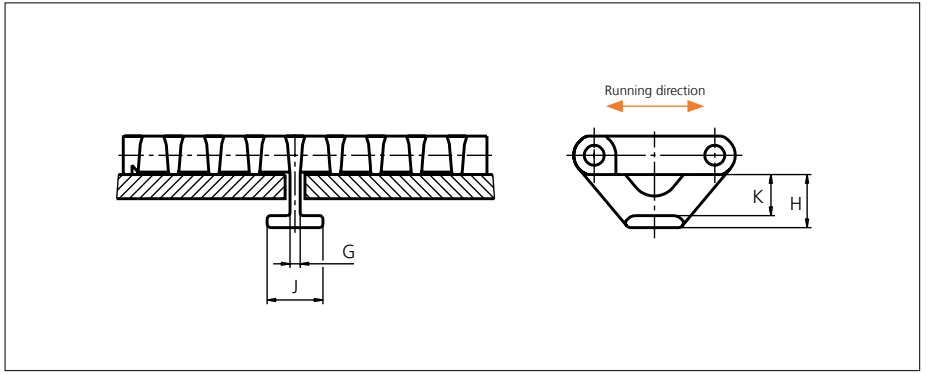

Type	Recommended material & color	G		H		J		K	
		mm	in	mm	in	mm	in	mm	in
Bottom Hold Down	POM-D <span style="border: 1px solid black; padding: 0 2px;">N</span>	4.2	0.17	22.0	0.87	23.2	0.92	17.0	0.67
	POM-LF <span style="background-color: #0056b3; color: white; padding: 0 2px;">B</span>								
	PP <span style="border: 1px solid black; padding: 0 2px;">W</span>								

Non Standard material and color: See uni Material and Color Overview.

## Sprocket

No of teeth	Bore size												Overall diameter		Pitch-diameter		Hub-diameter		Dimension A		Dimension B		Single row/Two way	Double row/Two way	Material	
	Pilot Bore		19.1	20.0	25.0	25.4	30.0	31.8	38.1	40.0	60.0	63.5													90.0	Molded
	mm	in																								
Z06	x				●	●	●	■	■				94.5	3.72	100.3	3.95	65	2.56	35.5	1.40	58.6	2.31	x		x	
Z08	x				●	●	●	■	■				129	5.08	131.1	5.16	65	2.56	52.6	2.07	74	2.91	x		x	
Z10	x					●	●	■	■				160.1	6.30	162.4	6.39	65	2.56	69.2	2.72	89.7	3.53	x		x	
Z12	x					●	●	■	■				191.5	7.54	193.9	7.63	65	2.56	85.7	3.37	105.5	4.15	x		x	
Z13	x					●		■	■				207.3	8.16	209.7	8.26	72	2.83	93.8	3.69	113.4	4.46	x		x	
Z13											■		207.3	8.16	209.7	8.26	150	5.91	93.8	3.69	113.4	4.46	x			x
Z16	x					●		■	■			■	254.8	10.03	257.3	10.13	200	7.87	118.2	4.65	137.1	5.40	x			x

■ Molded sprocket

● Molded sprocket

■ Machined sprocket

● Machined sprocket

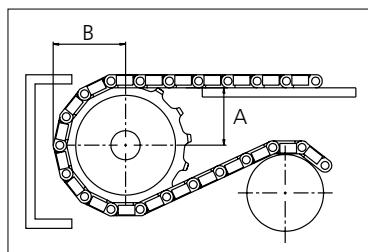
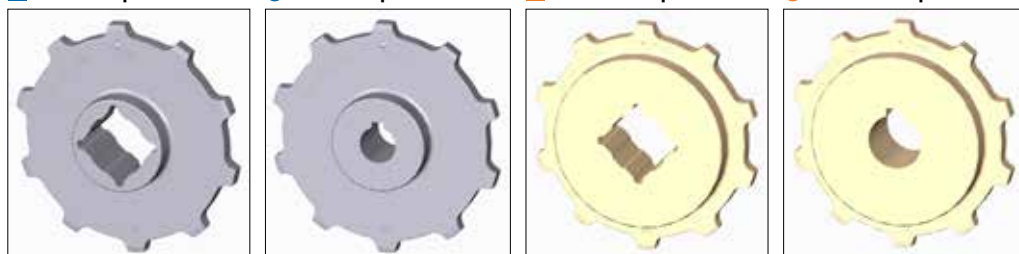

Other sprocket sizes are available upon request.  
 Two-part sprocket are available upon request.  
 Round bores are always delivered with keyway.  
 Other bore sizes are available upon request.  
 uni Retainer Rings: See uni Retainer Ring data sheet  
 Width of tooth = 11.0 mm (0.43 in)  
 Width of sprocket = 42.3 mm (1.67 in)

Max load per sprocket shown does not take bore size into account.  
 Please also ensure that sufficient size shaft is chosen for corresponding load.

For correct sprocket position: See uni Assembly Instructions for uni OPB.  
 For more detailed sprocket information, contact Customer Service.

Non standard material and color: See uni Material and Color Overview.



Conveyor Belts



Seamless Belts



Modular Belts



Timing Belts

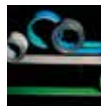

Transmission Belts



Fabrication & service

Solid advice  
For all your belting needs  
Local stock & service  
[www.ammeraalbeltech.com](http://www.ammeraalbeltech.com)

**Ammeraal Beltech Modular A/S**  
Hjulmagervej 21  
DK-7100 Vejle

T +45 7572 3100  
F +45 7572 3348  
admin@unichains.com  
www.unichains.com

This information is subject to alteration due to continuous development. Ammeraal Beltech will not be held liable for the incorrect use of the above stated information. This information replaces previous information. All activities performed and services rendered by Ammeraal Beltech are subject to general terms and conditions of sale and delivery, as applied by its operating companies.



# Plastic Modular Belt

Series **uni OWL** Type **66%**

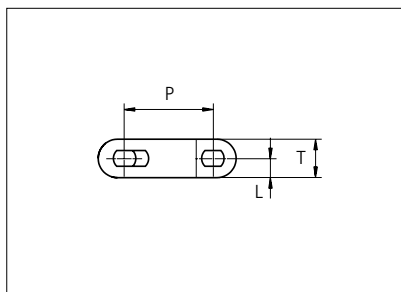

Straight running belt  
 Nominal pitch: 27.9 mm (1.10 in)  
 Surface type: Flat  
 Surface opening: 66%  
 Backflex radius: 40.0 mm (1.57 in)  
 Pin diameter: 4.0 mm (0.16 in)  
 Travel in both directions is possible.  
 uni-chains recommends this travel direction.

Belt material & color	PA6.6 GFH <b>K</b>	PA6.6 GFH <b>B</b>	PP <b>W</b>	PP <b>B</b>	mm	in	mm	in		
Pin and lock material & color	SS304 PA6.6 GFH <b>K</b>	SS304 PA6.6 GFH <b>B</b>	PBT <b>LG</b> PP <b>W</b>	PBT <b>LG</b> PP <b>B</b>	P (Nominal)	27.9	1.10	T	11.0	0.43
					L	5.5	0.22	-	-	-

Non standard material and color: See uni Material and Color Overview.

Alternative pin and lock materials: Pin: PA6.6 **B** PBT **LG** SS304

*Belt width		Permissible tensile force (Belt/pin material)				Belt weight (Belt/pin material)				**Min. No. drive sprocket per shaft	Number of wear strips (Min. No.)	
		PA6.6 GFH/SS		PP/PA6.6		PA6.6 GFH/SS		PP/PA6.6			***Carry (pcs)	***Return (pcs)
mm	in	N	lbf	N	lbf	kg/m	lb/ft	kg/m	lb/ft			
303	11.9	3636	817	2424	545	2.3	1.57	1.4	0.94	3	3	2
337	13.3	4040	908	2693	605	2.6	1.74	1.5	1.04	3	3	2
370	14.6	4443	999	2962	666	2.9	1.92	1.7	1.14	3	3	2
404	15.9	4847	1090	3231	726	3.1	2.09	1.9	1.25	3	3	2
438	17.2	5250	1180	3500	787	3.4	2.26	2.0	1.35	3	3	2
471	18.5	5654	1271	3769	847	3.6	2.44	2.2	1.46	4	4	2
505	19.9	6057	1362	4038	908	3.9	2.61	2.3	1.56	4	4	2
538	21.2	6461	1452	4307	968	4.1	2.79	2.5	1.66	4	4	2
572	22.5	6864	1543	4576	1029	4.4	2.96	2.6	1.77	4	4	2
606	23.8	7268	1634	4845	1089	4.7	3.13	2.8	1.87	5	5	3
639	25.2	7672	1725	5114	1150	4.9	3.31	2.9	1.98	5	5	3
673	26.5	8075	1815	5383	1210	5.2	3.48	3.1	2.08	5	5	3
707	27.8	8479	1906	5652	1271	5.4	3.66	3.3	2.18	5	5	3

Standard Increments in belt width : 33.6 mm (1.32 in).

1984	78.1	23808	5352	15872	3568	15.3	10.27	9.1	6.13	14	14	7
------	------	-------	------	-------	------	------	-------	-----	------	----	----	---

Standard Increments in belt width : 33.6 mm (1.32 in).

2993	117.8	35916	8074	23944	5383	23.0	15.49	13.8	9.25	20	20	10
------	-------	-------	------	-------	------	------	-------	------	------	----	----	----

\*The belt width in PA6.6 GFH is 1% wider than the belt width in the table

\*\*Max. Load per Drive Sprocket. Belt material: PA6.6 GFH 1200 N (270 lbf), PP 800 N (180 lbf)

\*\*\*Max. Spacing between wear strips, Carry: 152.0 mm (6.00 in); Return: 304.0 mm (12.00 in)

= Single Link



STANDARD

STRAIGHT RUNNING

PITCH 27.9 MM/1.10 IN

## Accessories

### Tab/NON STANDARD

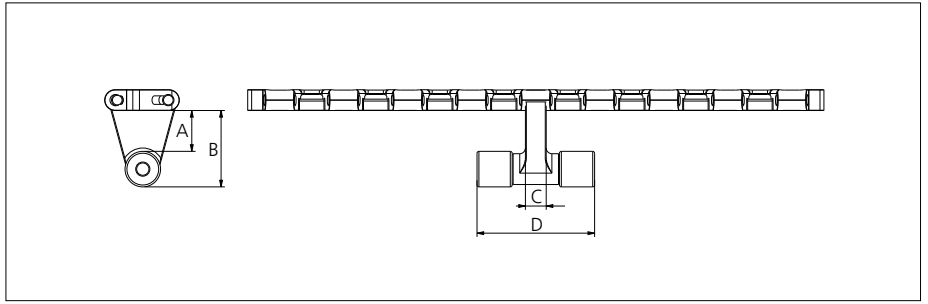
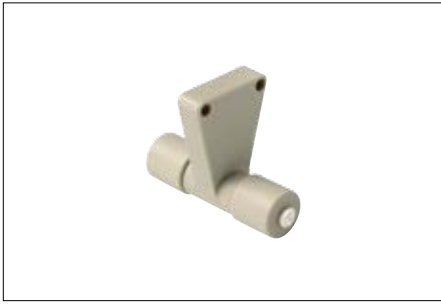

Type	Belt material & color	A		B		C		D	
		mm	in	mm	in	mm	in	mm	in
Bottom Hold Down Roller Tab	PP <b>W</b>	23.6	0.93	42.6	1.68	11.0	0.43	63.5	2.50

Non Standard material and color: See uni Material and Color Overview.

## Sprocket

No. of teeth	Bore size												Overall diameter		Pitch-diameter		Hub-diameter		A-dimension		B-dimension		Single row/One way	Double row/Two way	Molded PA6 LG	Machined PA6 N
	Pilot bore		0.75	0.78	0.98	1.00	1.18	1.25	1.50	1.57	2.36	2.50														
	mm	in	19.1	20.0	25.0	25.4	30.0	31.8	38.1	40.0	60.0	63.5	90.0	mm	in	mm	in	mm	in	mm	in					
<b>Z9</b>	x			■	●	●	●		■				82.7	3.26	80.2	3.16	63.7	2.51	32.8	1.29	46.4	1.83	x			x
<b>Z11</b>	x				●	●	●	■	■				101.0	3.98	97.9	3.85	82.0	3.23	42.0	1.65	55.1	2.17	x			x
<b>Z13</b>	x				●	●	●	■	■				119.2	4.69	115.6	4.55	100.2	3.94	51.1	2.01	63.8	2.51	x			x
<b>Z15</b>	x					●	●	●	■	■	■		137.3	5.41	133.4	5.25	118.3	4.66	60.1	2.37	72.6	2.86	x			x

■ Machined sprocket    ● Machined sprocket

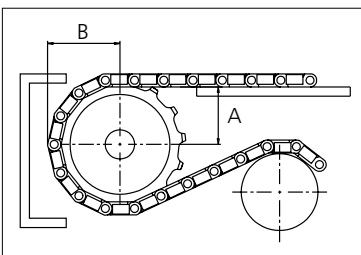
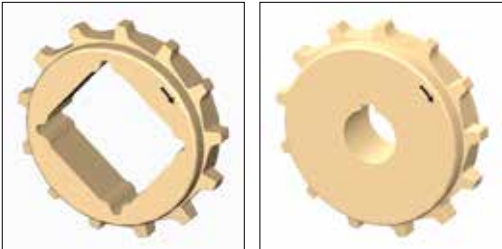

Other sprocket sizes are available upon request.  
 Two-part sprocket are available upon request.  
 Round bores are always delivered with keyway.  
 Other bore sizes are available upon request.  
 uni Retainer Rings: See uni Retainer Ring data sheet.  
 Width of tooth = 12.5 mm (0.49 in)  
 Width of sprocket = 30.0 mm (1.18 in)

Max load per sprocket shown does not take bore size into account.  
 Please also ensure that sufficient size shaft is chosen for corresponding load.

For correct sprocket position: See uni Assembly Instructions for uni OWL.  
 For more detailed sprocket information, contact Customer Service.

Non standard material and color: See uni Material and Color Overview.



Expert advice, quality solutions and local service for all your belting needs  
[www.ammeraalbeltech.com](http://www.ammeraalbeltech.com)

**Ammeraal Beltech Modular A/S**  
 Hjulmagervej 21  
 DK-7100 Vejle

T +45 7572 3100  
 F +45 7572 3348  
 admin@unichains.com  
 www.unichains.com

This information is subject to alteration due to continuous development. Ammeraal Beltech will not be held liable for the incorrect use of the above stated information. This information replaces previous information. All activities performed and services rendered by Ammeraal Beltech are subject to general terms and conditions of sale and delivery, as applied by its operating companies.





# Plastic Modular Belt

Series **uni QNB** Type **C**

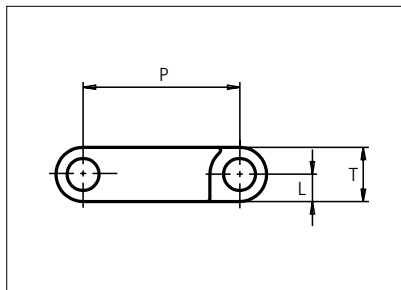
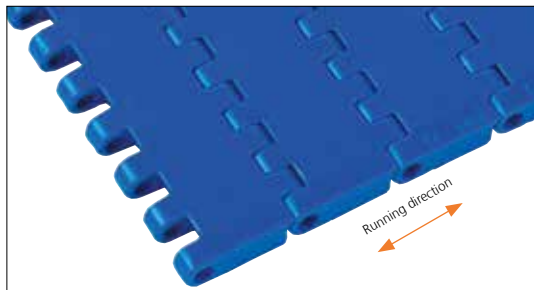

Straight running belt  
 Nominal pitch: 25.4 mm (1.00 in)  
 Surface type: Flat  
 Surface opening: Closed  
 Backflex radius: 40.0 mm (1.57 in)  
 Pin diameter: 5.0 mm (0.19 in)

Belt material & color	POM-SLF <b>B</b>	PP <b>B</b>	PP <b>W</b>	mm	in	mm	in		
				P (Nominal)	25.4	1.00	L	4.4	0.17
Pin material & color	PP <b>B</b>		PP <b>W</b>	T	8.8	0.35	-	-	-

Non standard material and color: See uni Material and Color Overview.

Alternative pin and lock materials: Solid Lockpin: PA6.6 **D** Pin: PP **W** PA6.6 **B** PE **W** PBT **LG** and SS304 Endlock: PA6.6 **D**  
 Lockpin: PBT **LG** PA6.6 **D** PP **B** **W**

Belt width		Permissible tensile force (Belt/pin material)				Belt weight (Belt/pin material)				*Min. No. drive sprocket per shaft	Number of wear strips (Min. No.)	
		POM-SLF/PP		PP/PP		POM-SLF/PP		PP/PP			**Carry (pcs)	**Return (pcs)
mm	in	N	lbf	N	lbf	kg/m	lb/ft	kg/m	lb/ft			
39	1.5	1365	307	780	175	0.3	0.22	0.2	0.14	1	1	1
51	2.0	1768	397	1010	227	0.4	0.29	0.3	0.18	2	1	1
77	3.0	2695	606	1540	346	0.6	0.43	0.4	0.28	2	2	2
153	6.0	5355	1204	3060	688	1.3	0.86	0.8	0.56	2	2	2
229	9.0	8015	1802	4580	1030	1.9	1.29	1.2	0.83	2	2	2
305	12.0	10675	2400	6100	1371	2.6	1.72	1.6	1.11	3	3	2
382	15.0	13370	3006	7640	1717	3.2	2.16	2.1	1.39	3	3	2
458	18.0	16030	3604	9160	2059	3.8	2.59	2.5	1.66	4	4	2
534	21.0	18690	4202	10680	2401	4.5	3.01	2.9	1.94	4	4	2
610	24.0	21350	4799	12200	2743	5.1	3.44	3.3	2.21	5	5	3
687	27.0	24045	5405	13740	3089	5.8	3.88	3.7	2.49	5	5	3
763	30.0	26705	6003	15260	3430	6.4	4.31	4.1	2.77	6	6	3

Additional standard belt widths are available in steps of 76.3 mm (3.00 in). Additional non-standard belt widths are available in steps of 25.4 mm (1.00 in).

1983	78.1	69405	15602	39660	8916	16.7	11.19	10.7	7.20	14	14	7
------	------	-------	-------	-------	------	------	-------	------	------	----	----	---

Additional standard belt widths are available in steps of 76.3 mm (3.00 in). Additional non-standard belt widths are available in steps of 25.4 mm (1.00 in).

2974	117.1	104090	23399	59480	13371	25.0	16.79	16.1	10.79	20	20	10
------	-------	--------	-------	-------	-------	------	-------	------	-------	----	----	----

General belt tolerance is +0/-0.4% at 23°C/73°F and 50% RH. For exact belt width contact Customer Service. Non standard belt width on request.

\*Max. Load per Drive Sprocket. Belt material: POM-SLF 2300 N (517 lbf), PP 1300 N (292 lbf).

\*\*Max. Spacing between wear strips, Carry: 152.0 mm (6.00 in); Return: 304.0 mm (12.00 in).

= Single Link



STANDARD

STRAIGHT RUNNING

PITCH 25.4 MM/1.00 IN

## Accessories

### Rubber Top

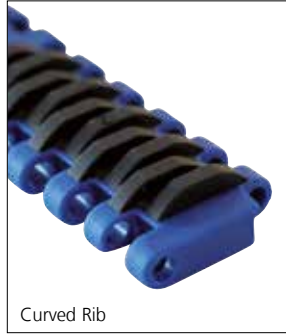

Curved Rib

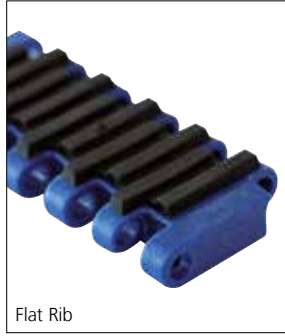

Flat Rib

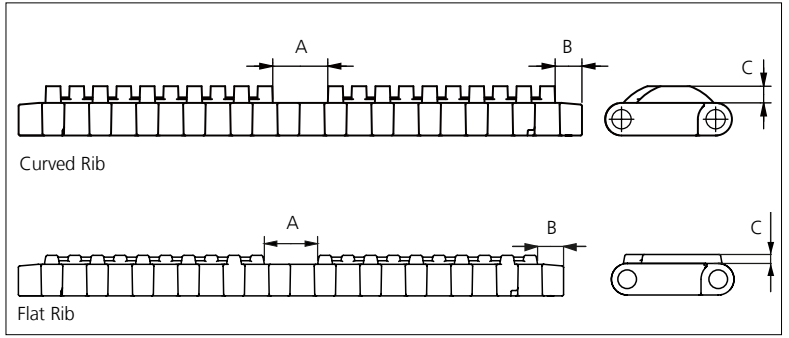

Curved Rib

Flat Rib

Type	Belt Material & color	Rubber Material & color	A		B		C		Link size	Width	
			mm	in	mm	in	mm	in		mm	in
Curved Rib	PP <b>B</b>	03 <b>K</b>	14.9	0.59	7.3	0.29	4.5	0.18	K300	75.8	2.98
			K600	152.0	5.98						
Flat Rib	PP <b>B</b>	03 <b>K</b>	14.85	0.58	7.25	0.29	2.5	0.10	K300	75.8	2.98
			K600	152.0	5.98						

Non Standard material and color: See uni Material and Color Overview.

## Accessories

### Flight

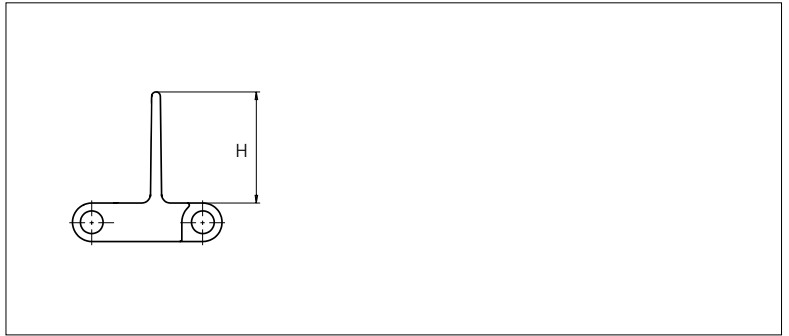
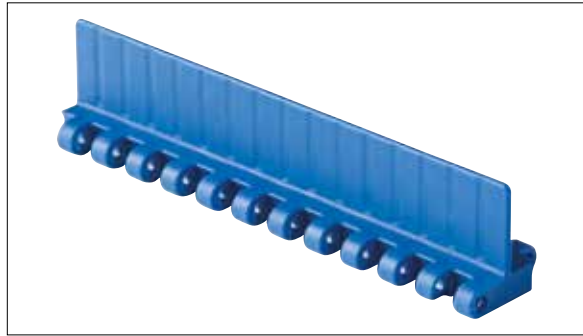

Type	Flight Material & color	H		Link size	Width		Indent	
		mm	in		mm	in	mm	in
Non Stick	PP-I <b>B</b> <b>W</b>	25.4	1.00	K600	152.0	5.98	0.0	0.00
	POM-SLF <b>B</b>							

Non Standard material and color: See uni Material and Color Overview.

### Accessories

#### NON STANDARD – Tab – Single Link Only

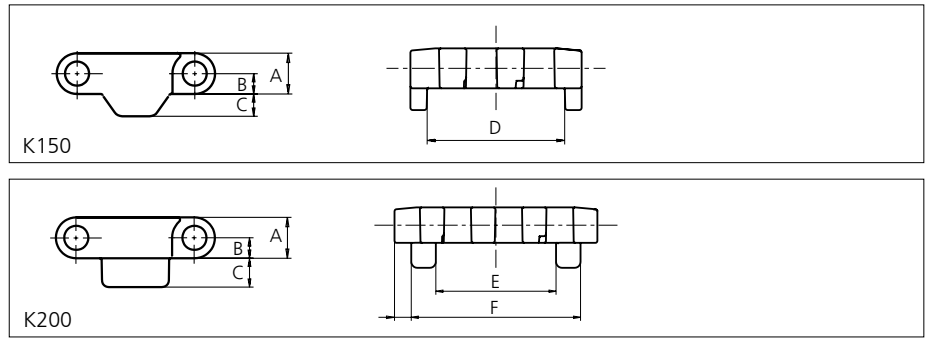
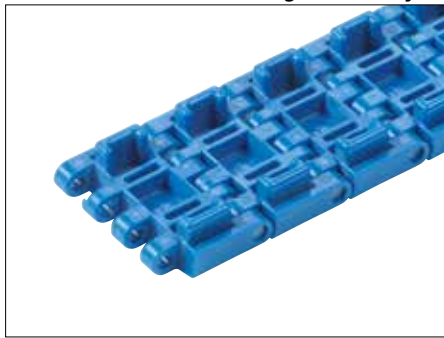

Type	Recommended link material & color	Recommended pin material & color	A		B		C		D		E		F		Link Size
			mm	in	mm	in	mm	in	mm	in	mm	in	mm	in	
Bottom Guide	POM-SLF <b>B</b>	PA6.6 <b>D</b>	8.8	0.35	4.4	0.17	4.8	0.19	30.3	1.19	29.9	1.18	42.1	1.66	K150
	PP <b>B</b>						6.2	0.24							K200

⚡ Solid Lockpin as default lock system. Alternative pin materials & color: PBT **LG**  
 Non Standard material and color: See uni Material and Color Overview.

### Accessories

#### AmFlight

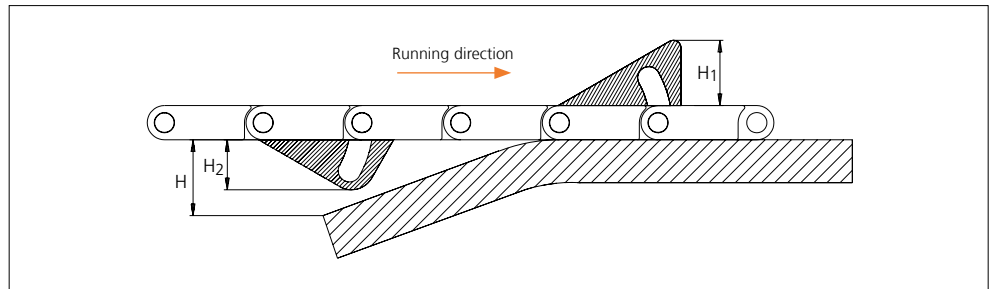
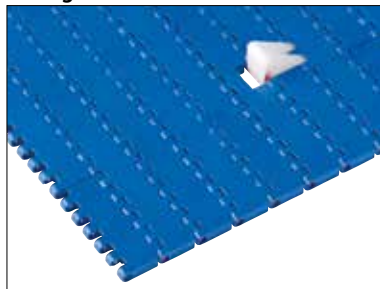

Type	Material & color	H		H <sup>1</sup>		H <sup>2</sup>	
		mm	in	mm	in	mm	in
Push	PE <b>W</b>	17.0	0.67	17.0	0.67	14.0	0.55

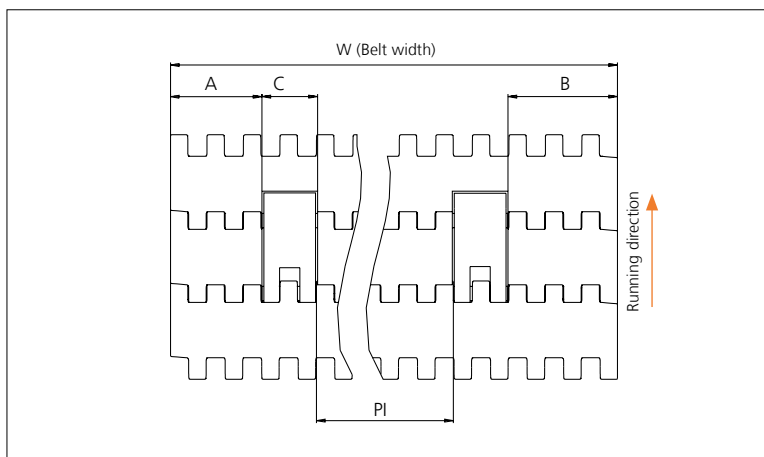

	mm	in
<b>A min</b>	32.4	1.28
<b>B min</b>	38.5	1.52
<b>C</b>	18.0	0.71
<b>PI max</b>	W - 106.9	W - 4.21
<b>PI min</b>	32.7	1.29

Increment: 12.7 mm (0.50 in)

## Sprocket

No. of teeth	Bore size										Overall diameter		Pitch diameter		Hub diameter		Dimension A		Dimension B		Single row/Two way	Moulded	PA6 LG
	Pilot bore	1.00		1.18		1.25		1.50		1.57													
	mm	38.1	40.0	60.0	63.5	mm	in	mm	in	mm	in	mm	in	mm	in	mm	in						
Z10	✓	●	●	●	■	●				80.3	3.16	82.2	3.24	65.0	2.56	34.7	1.36	45.5	1.79	✓	✓		
Z12	✓	●	●	●	■	●				96.8	3.81	98.1	3.86	70.0	2.76	43.0	1.69	53.5	2.11	✓	✓		
Z15	✓		●	●	■	●	■	■	■	121.5	4.78	122.2	4.81	<sup>1</sup> 70.0 <sup>2</sup> 100.0 <sup>2</sup> 104.0	2.76 13.94 4.09	55.4	2.18	65.5	2.58	✓	✓		
Z18	✓		●	●	■	●	■	■	■	146.0	5.75	146.3	5.76	<sup>1</sup> 70.0 <sup>1</sup> 120.0 <sup>2</sup> 104.0 <sup>2</sup> 104.0	2.76 14.72 4.09 4.72	67.6	2.66	77.5	3.05	✓	✓		
Z19	✓		●	●	■	●	■	■	■	154.2	6.07	154.3	6.07	<sup>1</sup> 70.0 <sup>1</sup> 120.0 <sup>2</sup> 104.0 <sup>2</sup> 104.0	2.76 14.72 4.09 4.72	71.7	2.82	81.6	3.21	✓	✓		

● Moulded sprocket ■ Moulded sprocket ■ Moulded sprocket

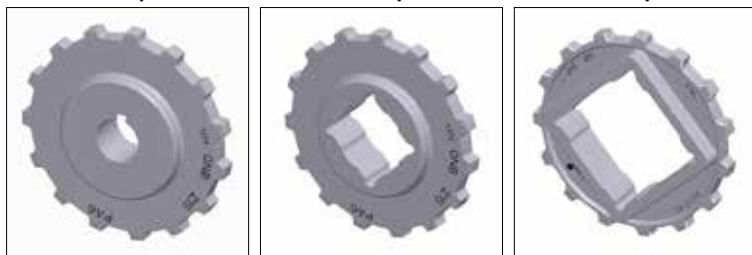

Other sprocket sizes are available upon request.  
 Max load per sprocket shown does not take bore size into account.  
 Please also ensure that sufficient size shaft is chosen for corresponding load.  
 Other bore sizes are available upon request.  
 uni Retainer Rings: See uni Retainer Ring data sheet.  
 Width of tooth = 10.0 mm (0.39 in)  
 Width of OnePart sprocket = 25.0 mm (0.98 in)

## uni UltraFit Two-Part Sprocket

No. of teeth	Bore size					Overall diameter		Pitch diameter		Hub/adaptor diameter		Hub/adaptor width		Dimension A		Dimension B		Single row/Two way	Moulded	PA6 LG	Adapter Moulded	POM-D B
	in	1.50	1.57	2.36	2.50																	
	mm	38.1	40.0	60.0	63.5	mm	in	mm	in	mm	in	mm	in	mm	in	mm	in					
Z12		■	■			96.8	3.81	98.2	3.87	83.0	3.27	25.0 76.0	0.98 2.99	43	1.69	53.5	2.11	✓	✓	✓	✓	
Z13		■	■			104.8	4.13	106.2	4.18	83.0	3.27	25.0 76.0	0.98 2.99	47.1	1.86	57.1	2.25	✓	✓	✓	✓	
Z15		■	■	■	■	121.5	4.78	122.5	4.82	106.0	4.14	25.0 76.0	0.98 2.99	55.4	2.18	65.5	2.58	✓	✓	✓	✓	
Z16		■	■	■	■	129.7	5.11	130.2	5.13	106.0	4.14	25.0 76.0	0.98 2.99	59.5	2.35	69.5	2.74	✓	✓	✓	✓	
Z18		■	■	■	■	146.1	5.75	146.3	5.76	106.0	4.14	25.0 76.0	0.98 2.99	67.6	2.66	77.5	3.05	✓	✓	✓	✓	
Z19		■	■	■	■	154.2	6.07	154.3	6.07	106.0	4.14	25.0 76.0	0.98 2.99	71.7	2.82	81.6	3.21	✓	✓	✓	✓	

■ Moulded uni UltraFit TwoPart Sprocket (Narrow adapter) ■ Moulded uni UltraFit TwoPart Sprocket (Wide adapter)

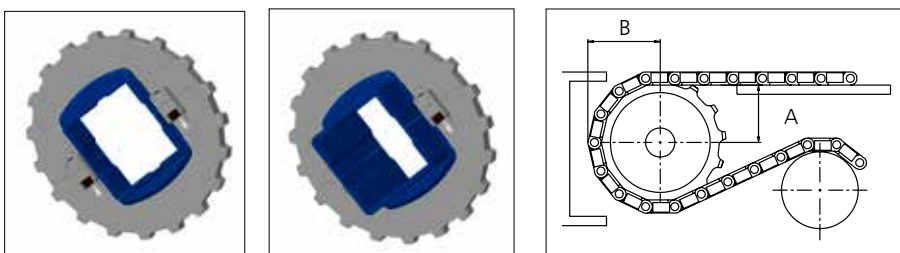

For correct sprocket position:  
 See uni Assembly Instructions for uni QNB.  
 For more detailed sprocket information contact Customer Service.



Expert advice, quality solutions and local service for all your belting needs  
[www.ammeraalbeltech.com](http://www.ammeraalbeltech.com)

**Ammeraal Beltech Modular A/S**  
 Hjulmagervej 21  
 DK-7100 Vejle

T +45 7572 3100  
 F +45 7572 3348  
 admin@unichains.com  
 www.unichains.com

This information is subject to alteration due to continuous development. Ammeraal Beltech will not be held liable for the incorrect use of the above stated information. This information replaces previous information. All activities performed and services rendered by Ammeraal Beltech are subject to general terms and conditions of sale and delivery, as applied by its operating companies.



# Plastic Modular Belt

Series **uni QNB** Type **Rough**

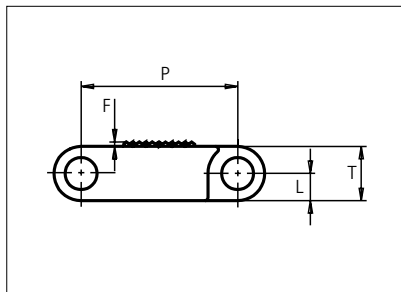
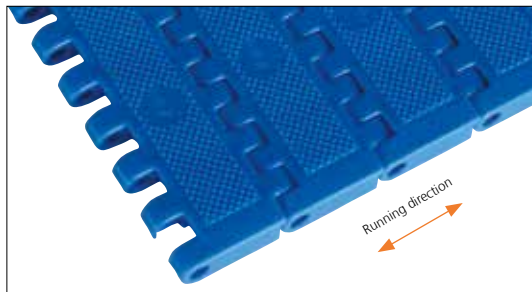

Straight running belt  
 Nominal pitch: 25.4 mm (1.00 in)  
 Surface type: Rough Top  
 Surface opening: Closed  
 Backflex radius: 40.0 mm (1.57 in)  
 Pin diameter: 5.0 mm (0.31 in)

<b>Belt material &amp; color</b>	POM-SLF <b>B</b>		<b>mm</b>	<b>in</b>		<b>mm</b>	<b>in</b>
<b>Pin material &amp; color</b>	PP <b>B</b>	<b>P (Nominal)</b>	25.4	1.00	<b>L</b>	4.4	0.17
		<b>F</b>	0.8	0.03	<b>T</b>	8.8	0.35

Non standard material and color: See uni Material and Color Overview.

Alternative pin and lock materials: Solid Lockpin: PA6.6 **D** Pin: PP **W** PA6.6 **B** PE **W** PBT **LG** and SS304 Endlock: PA6.6 **D**  
 Lockpin: PBT **LG** PA6.6 **D** **N** PP **B** **W**

Belt width		Permissible tensile force (Belt/pin material)		Belt weight (Belt/pin material)		*Min. No. drive sprocket per shaft	Number of wear strips (Min. No.)	
		POM-SLF/PP		POM-SLF/PP			**Carry (pcs)	**Return (pcs)
mm	in	N	lbf	kg/m	lb/ft			
77	3.0	2695	606	0.6	0.43	2	2	2
153	6.0	5355	1204	1.3	0.86	2	2	2
229	9.0	8015	1802	1.9	1.29	2	2	2
305	12.0	10675	2400	2.6	1.72	3	3	2
382	15.0	13370	3006	3.2	2.16	3	3	2
458	18.0	16030	3604	3.8	2.59	4	4	2
534	21.0	18690	4202	4.5	3.01	4	4	2
610	24.0	21350	4799	5.1	3.44	5	5	3
687	27.0	24045	5405	5.8	3.88	5	5	3
763	30.0	26705	6003	6.4	4.31	6	6	3
839	33.0	29365	6601	7.0	4.74	6	6	3
915	36.0	32025	7199	7.7	5.17	7	7	4
992	39.1	34720	7805	8.3	5.60	7	7	4

Additional standard belt widths are available in steps of 76.3 mm (3.00 in). Additional non-standard belt widths are available in steps of 25.4 mm (1.00 in).

1983	78.1	69405	15602	16.7	11.19	14	14	7
------	------	-------	-------	------	-------	----	----	---

Additional standard belt widths are available in steps of 76.3 mm (3.00 in). Additional non-standard belt widths are available in steps of 25.4 mm (1.00 in).

2974	117.1	104090	23399	25.0	16.79	20	20	10
------	-------	--------	-------	------	-------	----	----	----

General belt tolerance is +0/-0.4% at 23°C/73°F and 50% RH. For exact belt width contact Customer Service. Non standard belt width on request.

\*Max. Load per Drive Sprocket. Belt material: POM-SLF 2300 N (517 lbf), PP 1300 N (292 lbf).  
 \*\*Max. Spacing between wear strips, Carry: 152.0 mm (6.00 in); Return: 304.0 mm (12.00 in).

= Single Link



STANDARD

STRAIGHT RUNNING

PITCH 25.4 MM/1.00 IN

## Accessories

### Rubber Top

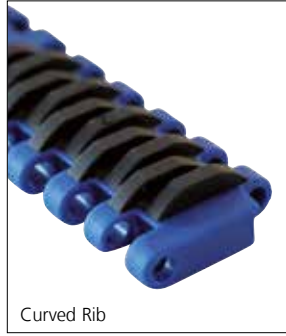

Curved Rib

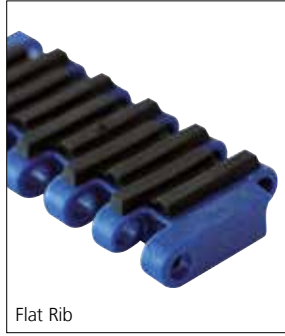

Flat Rib

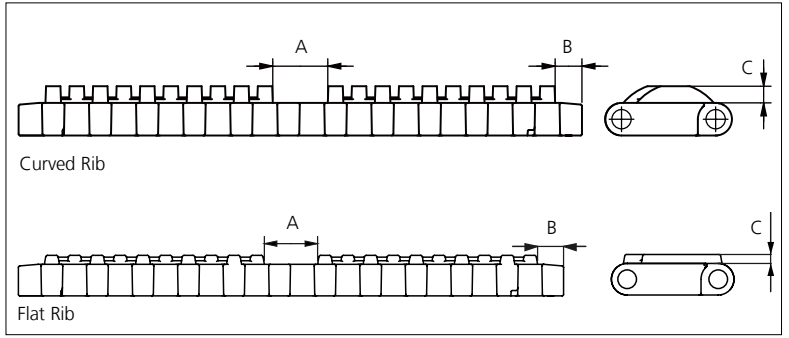

Curved Rib

Flat Rib

Type	Belt Material & color	Rubber Material & color	A		B		C		Link size	Width	
			mm	in	mm	in	mm	in		mm	in
Curved Rib	PP <b>B</b>	03 <b>K</b>	14.9	0.59	7.3	0.29	4.5	0.18	K300	75.8	2.98
Flat Rib			14.85	0.58	7.25	0.29	2.5	0.10	K300	75.8	2.98
									K600	152.0	5.98

Non Standard material and color: See uni Material and Color Overview.

## Accessories

### Flight

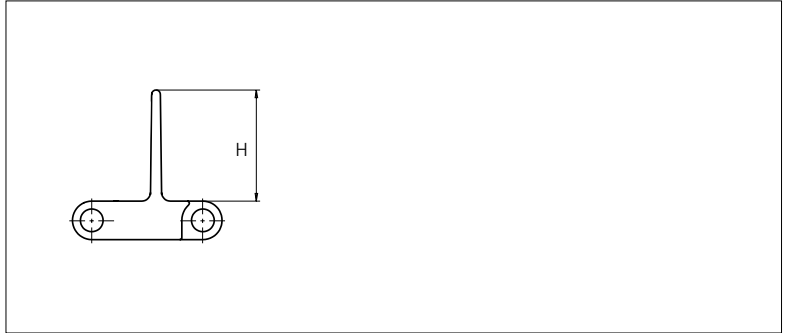
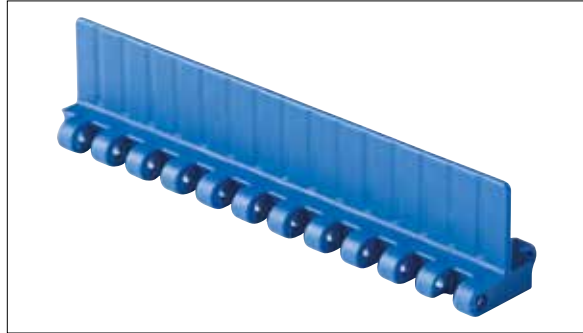

Type	Flight Material & color	H		Link size	Width		Indent	
		mm	in		mm	in	mm	in
Non Stick	PP-I <b>B W</b>	25.4	1.00	K600	152.0	5.98	0.0	0.00
	POM-SLF <b>B</b>							

Non Standard material and color: See uni Material and Color Overview.

## Accessories

### Non Standard uni AmFlight

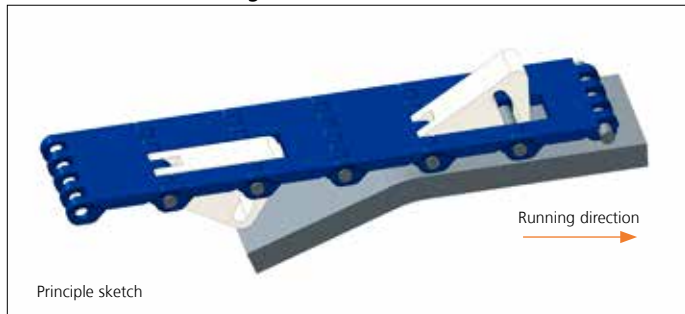

Principle sketch

### Sprocket

No. of teeth	Bore size										Overall diameter		Pitch diameter		Hub diameter		Dimension A		Dimension B		Single row/Two way	PAG LG	
	Pilot bore	1.00		1.18		1.25		1.50		2.36													2.50
	mm	in	25.4	30.0	31.8	38.1	40.0	60.0	63.5	mm	in	mm	in	mm	in	mm	in	mm	in	mm	in	mm	in
Z10	✓		●	●	●	■	●					80.3	3.16	82.2	3.24	65.0	2.56	34.7	1.36	45.5	1.79	✓	✓
Z12	✓		●	●	●	■	■					96.8	3.81	98.1	3.86	70.0	2.76	43.0	1.69	53.5	2.11	✓	✓
Z15	✓			●	●	■	■			2	1	121.5	4.78	122.2	4.81	70.0 100.0 104.0	2.76 3.94 4.09	55.4	2.18	65.5	2.58	✓	✓
Z18	✓			●	●	■	■			2	1	146.0	5.75	146.3	5.76	70.0 104.0 120.0	2.76 4.09 4.72	67.6	2.66	77.5	3.05	✓	✓
Z19	✓			●	●	■	■			1	1	154.2	6.07	154.3	6.07	70.0 120.0	2.76 4.72	71.7	2.82	81.6	3.21	✓	✓

● Moulded sprocket   ■ Moulded sprocket   ■ Moulded sprocket

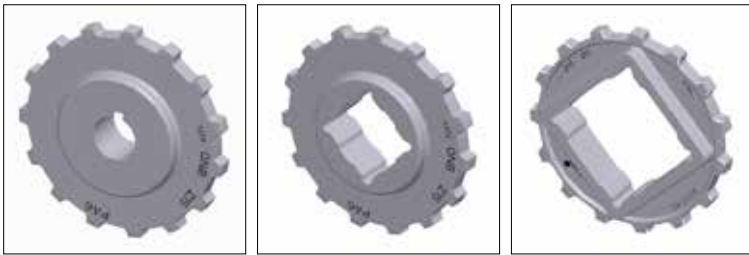

Other sprocket sizes are available upon request.  
 Max load per sprocket shown does not take bore size into account.  
 Please also ensure that sufficient size shaft is chosen for corresponding load.  
 Other bore sizes are available upon request.  
 uni Retainer Rings: See uni Retainer Ring data sheet.  
 Width of tooth = 10.0 mm (0.39 in)  
 Width of OnePart sprocket = 25.0 mm (0.98 in)

### uni UltraFit Two-Part Sprocket

No. of teeth	Bore size					Overall diameter		Pitch diameter		Hub/adaptor diameter		Hub/adaptor width		Dimension A		Dimension B		Single row/Two way	PAG LG	Moulded	Adapter Moulded
	in	1.50	1.57	2.36	2.50																
	mm	38.1	40.0	60.0	63.5	mm	in	mm	in	mm	in	mm	in	mm	in	mm	in	mm	in	mm	in
Z12		■	■			96.8	3.81	98.2	3.87	83.0	3.27	25.0 76.0	0.98 2.99	43	1.69	53.5	2.11	✓	✓	✓	
Z13		■	■			104.8	4.13	106.2	4.18	83.0	3.27	25.0 76.0	0.98 2.99	47.1	1.86	57.1	2.25	✓	✓	✓	
Z15		■	■	■	■	121.5	4.78	122.5	4.82	106.0	4.14	25.0 76.0	0.98 2.99	55.4	2.18	65.5	2.58	✓	✓	✓	
Z16		■	■	■	■	129.7	5.11	130.2	5.13	106.0	4.14	25.0 76.0	0.98 2.99	59.5	2.35	69.5	2.74	✓	✓	✓	
Z18		■	■	■	■	146.1	5.75	146.3	5.76	106.0	4.14	25.0 76.0	0.98 2.99	67.6	2.66	77.5	3.05	✓	✓	✓	
Z19		■	■	■	■	154.2	6.07	154.3	6.07	106.0	4.14	25.0 76.0	0.98 2.99	71.7	2.82	81.6	3.21	✓	✓	✓	

■ Moulded uni UltraFit TwoPart Sprocket (Narrow adapter)   ■ Moulded uni UltraFit TwoPart Sprocket (Wide adapter)

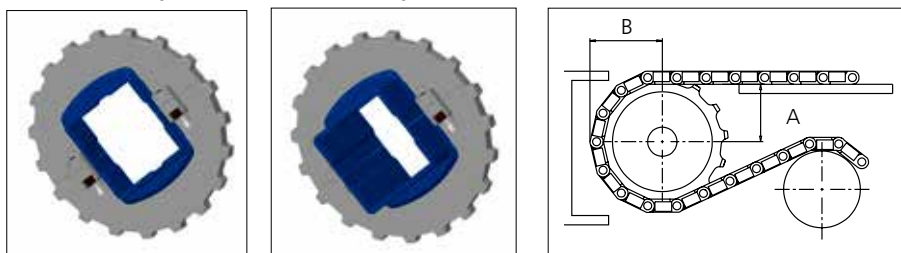

For correct sprocket position:  
 See uni Assembly Instructions for uni QNB.  
 For more detailed sprocket information contact Customer Service.



Conveyor Belts



Seamless Belts

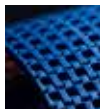

Modular Belts



Timing Belts

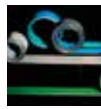

Transmission Belts



Fabrication & service

Expert advice, quality solutions and local service for all your belting needs [www.ammeraalbeltech.com](http://www.ammeraalbeltech.com)

**Ammeraal Beltech Modular A/S**  
Hjulmagervej 21  
DK-7100 Vejle

T +45 7572 3100  
F +45 7572 3348  
admin@unichains.com  
www.unichains.com

This information is subject to alteration due to continuous development. Ammeraal Beltech will not be held liable for the incorrect use of the above stated information. This information replaces previous information. All activities performed and services rendered by Ammeraal Beltech are subject to general terms and conditions of sale and delivery, as applied by its operating companies.





# Plastic Modular Belt

Series **uni QNB** Type **Ball**

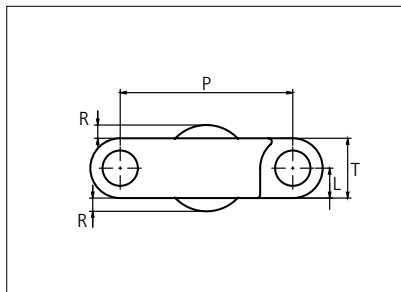
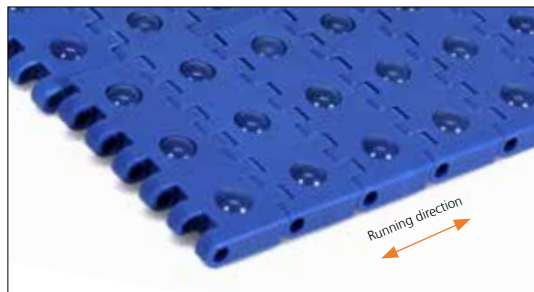

Straight running belt  
 Nominal pitch: 25.4 mm (1.00 in)  
 Surface type: Ball  
 Surface opening: Closed  
 Backflex radius: 25.0 mm (0.98 in)  
 Pin diameter: 5.0 mm (0.20 in)

<b>Belt material &amp; color</b>	POM-SLF <b>B</b>		<b>mm</b>	<b>in</b>		<b>mm</b>	<b>in</b>
<b>Ball material &amp; color</b>	PA6.6 <b>B</b>	<b>P (Nominal)</b>	25.4	1.00	<b>R</b>	1.95	0.08
<b>Pin material &amp; color</b>	PP <b>B</b>	<b>L</b>	4.4	0.17	<b>T</b>	8.8	0.35

Non standard material and color: See uni Material and Color Overview.

Belt width		Permissible tensile force (Belt/pin material)		Belt weight (Belt/pin material)		*Min No drive sprocket per shaft	Number of wear strips (min no)	
		POM-SLF/PP		POM-SLF/PP			**Carry (pcs)	**Return (pcs)
mm	in	N	lbf	Kg/m	lb/ft			
76	3.0	1710	384	0.7	0.48	2	2	2
153	6.0	3443	774	1.4	0.96	2	2	2
229	9.0	5153	1158	2.1	1.43	2	2	2
305	12.0	6863	1543	2.8	1.91	3	3	2
381	15.0	8573	1927	3.5	2.38	3	3	2
457	18.0	10283	2312	4.3	2.86	4	4	2
533	21.0	11993	2696	5.0	3.33	4	4	2
609	24.0	13703	3080	5.7	3.81	5	5	3
685	27.0	15413	3465	6.4	4.28	5	5	3
761	30.0	17123	3849	7.1	4.76	6	6	3
838	33.0	18855	4239	7.8	5.24	6	6	3
914	36.0	20565	4623	8.5	5.71	7	7	4
990	39.0	22275	5007	9.2	6.19	7	7	4
1066	42.0	23985	5392	9.9	6.66	8	8	4

Additional standard belt widths are available in steps of 76.3 mm (3.00 in).

1979	77.9	44528	10010	18.4	12.37	14	14	7
------	------	-------	-------	------	-------	----	----	---

Additional standard belt widths are available in steps of 76.3 mm (3.00 in).

2968	116.9	66780	15012	27.6	18.55	20	20	10
------	-------	-------	-------	------	-------	----	----	----

General belt tolerance is +0/-0.4% at 23°C/73°F and 50% RH. For exact belt width contact Customer Service.

\*Max. Load per Drive Sprocket. Belt material: POM-SLF 1840 N (414 lbf).

\*\*Max. Spacing between wear strips, Carry: 152.0 mm (6.00 in); Return: 304.0 mm (12.00 in).

□ = Single Link



STANDARD

STRAIGHT RUNNING

PITCH 25.4 MM/1.00 IN

## Sprocket

No. of teeth	Bore size						Overall diameter		Pitch diameter		Hub diameter		Dimension A		Dimension B		Single row/Two way	Machined	
	Pilot bore	in	1.50	1.57	2.36	2.50													
	mm	38.1	40.0	60.0	63.5	mm	in	mm	in	mm	in	mm	in	mm	in				
Z15	✓		■	■	■	■	121.5	4.78	122.5	4.82	100.0	3.93	55.4	2.18	66.1	2.60	✓	✓	
Z18	✓		■	■	■	■	146.1	5.75	146.3	5.76	120.0	4.72	67.6	2.66	78.4	3.08	✓	✓	
Z19	✓		■	■	■	■	154.2	6.07	154.3	6.07	125.0	4.92	71.7	2.82	82.5	3.24	✓	✓	

Non standard material and color: See uni Material and Color Overview.

### ■ Machined sprocket

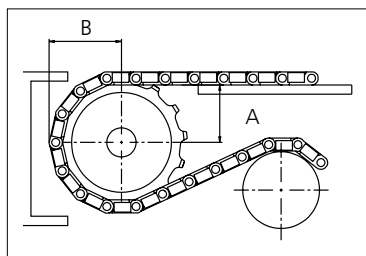

Other sprocket sizes are available upon request.  
 Two-part sprockets are available upon request.  
 Other bore sizes are available upon request.  
 uni Retainer Rings: See uni Retainer Ring data sheet.  
 Width of tooth = 8.0 mm (0.31 in)  
 Width of sprocket = 25.0 mm (0.98 in)

Max load per sprocket shown does not take bore size into account.  
 Please also ensure that sufficient size shaft is chosen for corresponding load.

For correct sprocket position: See uni Assembly Instructions for uni QNB Ball.  
 For more detailed sprocket information, contact Customer Service.

uni QNB Ball/2019.09.11



Expert advice, quality solutions and local service for all your belting needs  
[www.ammeraalbeltech.com](http://www.ammeraalbeltech.com)

**Ammeraal Beltech Modular A/S**  
 Hjulmagervej 21  
 DK-7100 Vejle

T +45 7572 3100  
 F +45 7572 3348  
 admin@unichains.com  
 www.unichains.com

This information is subject to alteration due to continuous development. Ammeraal Beltech will not be held liable for the incorrect use of the above stated information. This information replaces previous information. All activities performed and services rendered by Ammeraal Beltech are subject to general terms and conditions of sale and delivery, as applied by its operating companies.



# Plastic Modular Belt

Series **uni RTB** Type **M1**

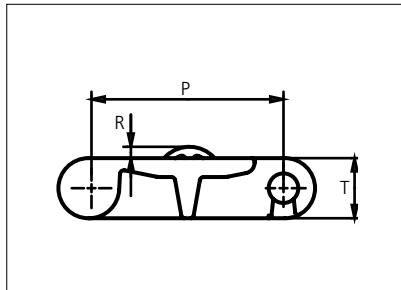

Straight running belt  
 Nominal pitch: 50.8 mm (2.00 in)  
 Surface type: Roller Top  
 Surface opening: Closed  
 Backflex radius: 65.0 mm (2.56 in)  
 uni Snap link (pinless)

<b>Belt material &amp; color</b>	POM-S <b>B</b>
<b>Roller material &amp; color</b>	POM-NL <b>G</b>
<b>Cover plate material &amp; color</b>	POM-NL <b>B</b>
<b>Pin for roller material &amp; color</b>	SS304

	<b>mm</b>	<b>in</b>		<b>mm</b>	<b>in</b>
<b>P (Nominal)</b>	50.8	2.00	<b>T</b>	16.0	0.63
<b>R</b>	3.0	0.12	-	-	-

**Roller Positions**

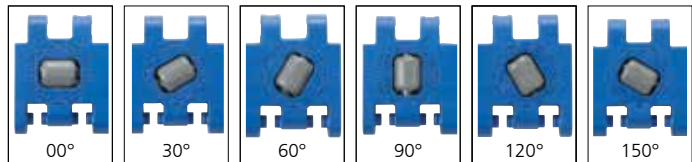

Non standard material and color: See uni Material and Color Overview.

Belt width		Permissible tensile force (Belt/pin material)		Belt weight (Belt/pin material)		*Min. No. drive sprocket per shaft	Number of wear strips (Min. No.)	
		POM-S		POM-S			**Carry (pcs)	**Return (pcs)
mm	in	N	lbf	kg/m	lb/ft			
153	6.0	4208	946	2.2	1.49	2	2	2
204	8.0	5611	1261	3.0	1.99	2	2	2
255	10.0	7014	1577	3.7	2.49	2	2	2
306	12.1	8417	1892	4.4	2.98	3	3	2
357	14.1	9821	2208	5.2	3.48	3	3	2
408	16.1	11224	2523	5.9	3.98	3	3	2
459	18.1	12627	2839	6.7	4.47	4	4	2
510	20.1	14031	3154	7.4	4.97	4	4	2
561	22.1	15434	3470	8.1	5.47	4	4	2
612	24.1	16837	3785	8.9	5.97	5	5	3
663	26.1	18240	4100	9.6	6.46	5	5	3

Additional standard belt widths are available in steps of 51.0 mm (2.01 in).

1989	78.3	54698	12296	28.8	19.38	14	14	7
------	------	-------	-------	------	-------	----	----	---

Additional standard belt widths are available in steps of 51.0 mm (2.01 in).

2958	116.5	81345	18286	42.9	28.82	20	20	10
------	-------	-------	-------	------	-------	----	----	----

General belt tolerance is +0/-0.4% at 23°C/73°F and 50% RH. For exact belt width contact Customer Service. Non standard belt width on request.

\*Max. Load per Drive Sprocket. Belt material: POM-S 2000 N (450 lbf).

\*\*Max. Spacing between wear strips, Carry: 152.0 mm (6.00 in); Return: 304.0 mm (12.00 in).

= Single Link



STANDARD

STRAIGHT RUNNING

PITCH 50.8 MM/2.00 IN

## Sprocket

No. of teeth	Bore size									Overall diameter		Pitch-diameter		Hub-diameter		Dimension A		Dimension B		Single row/One way	Molded	Machined
	Pilot bore																					
	mm	in	1.00	1.18	1.25	1.50	1.57	2.36	2.50	mm	in	mm	in	mm	in	mm	in					
Z08	✓		●	●	●	■	●			132.9	5.23	132.8	5.23	65.0	2.56	53.3	2.10	74.6	2.93	✓	✓	
Z10	✓			●	●	●	■	●		166.3	6.55	164.4	6.47	65.0	2.56	70.2	2.76	90.4	3.56	✓	✓	
Z10								■	■	166.3	6.55	164.4	6.47	120.0	4.72	70.2	2.76	90.4	3.56	✓	✓	
Z12	✓			●	●	●	■	●		198.6	7.82	196.3	7.73	65.0	2.56	86.8	3.42	106.3	4.18	✓	✓	
Z12								■	■	198.6	7.82	196.3	7.73	120.0	4.72	86.8	3.42	106.3	4.18	✓	✓	
Z16	✓			●	●	●	■	■	■	263.8	10.39	260.4	10.25	150.0	5.90	119.7	4.71	138.3	5.44	✓		✓

● Molded sprocket

■ Machined sprocket



Other sprocket sizes are available upon request.

Other bore sizes on sprockets are available upon request.

Round bores are always delivered with keyway.

Max. load per sprocket shown does not take bore size into account.

Please also ensure that sufficient size shaft is chosen for corresponding load.

Width of tooth = Single row 9.5 mm (0.37 in)

Width of One-part sprocket = Single row: 42.3 mm (1.67 in)

## uni UltraClean Two-Part Sprocket

No. of teeth	Bore size				Overall diameter		Pitch-diameter		Hub-diameter		Dimension A		Dimension B		Single row/One way	Moulded
	in	1.50	1.57	2.36												
	mm	38.1	40.0	60.0	mm	in	mm	in	mm	in	mm	in				
Z8		■	■		132.9	5.23	132.8	5.23	80.0	3.15	53.3	2.10	74.9	2.94	✓	✓
Z10		1 ■	1 ■	2 ■	166.3	6.55	164.4	6.47	<sup>1</sup> 126.0 <sup>2</sup> 118.0	<sup>1</sup> 4.96 <sup>2</sup> 4.65	70.2	2.76	90.7	3.57	✓	✓
Z12		1 ■	1 ■	2 ■	198.6	7.82	196.3	7.73	<sup>1</sup> 126.0 <sup>2</sup> 118.0	<sup>1</sup> 4.96 <sup>2</sup> 4.65	86.8	3.42	106.6	4.19	✓	✓

■ Moulded uni UltraClean TwoPart Sprocket

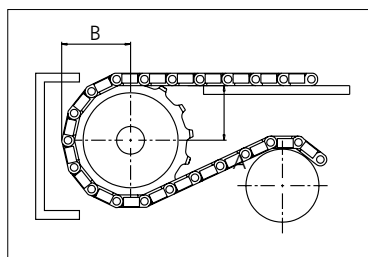

Width of UltraClean Two-part sprocket = Single row: 44.0 mm (1.73 in)

Width of UltraClean Two-part sprocket, tooth = Single row: 9.5 mm (0.37 in)

uni Retainer Rings: See uni Retainer Ring data sheet.

For correct sprocket position: See uni Assembly Instructions for uni RTB.

For more detailed sprocket information, contact Customer Service.



Conveyor Belts



Seamless Belts



Modular Belts



Timing Belts



Transmission Belts



Fabrication & service

Expert advice, quality solutions and local service for all your belting needs  
[www.ammeraalbeltech.com](http://www.ammeraalbeltech.com)

**Ammeraal Beltech Modular A/S**  
Hjulgagervej 21  
DK-7100 Vejle

T +45 7572 3100  
F +45 7572 3348  
admin@unichains.com  
www.unichains.com

This information is subject to alteration due to continuous development. Ammeraal Beltech will not be held liable for the incorrect use of the above stated information. This information replaces previous information. All activities performed and services rendered by Ammeraal Beltech are subject to general terms and conditions of sale and delivery, as applied by its operating companies.



# Plastic Modular Belt

Series **uni RTB** Type **M2 Rubber Top**

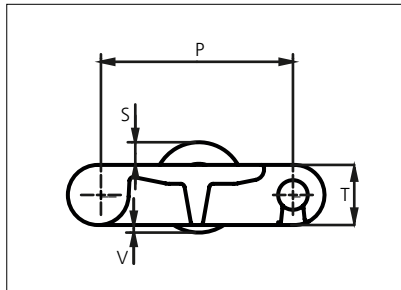

Straight running belt  
 Nominal pitch: 50.8 mm (2.00 in)  
 Surface type: Roller Top  
 Surface opening: Closed  
 Backflex radius: 65.0 mm (2.56 in)  
 uni Snap link (pinless)

<b>Belt material &amp; color</b>	POM-S <b>B</b>	<b>P</b> (Nominal)	mm 50.8	in 2.00	<b>T</b>	mm 16.0	in 0.63
<b>Roller and Rubber material &amp; color</b>	POM-NL <b>O</b> 01 <b>K</b>	<b>S</b>	mm 6.0	in 0.24	<b>V</b>	mm 2.0	in 0.08
<b>Cover plate material &amp; color</b>	POM-NL <b>O</b>	<b>Roller Positions</b>					
<b>Pin for roller material &amp; color</b>	SS304						

Non standard material and color: See uni Material and Color Overview.

Belt width		Permissible tensile force (Belt/pin material)		Belt weight (Belt/pin material)		*Min. No. drive sprocket per shaft	Number of wear strips (Min. No.)	
		POM-S		POM-S			**Carry (pcs)	**Return (pcs)
mm	in	N	lbf	kg/m	lb/ft			
153	6.0	4208	946	2.2	1.49	2	2	2
204	8.0	5611	1261	3.0	1.99	2	2	2
255	10.0	7014	1577	3.7	2.49	2	2	2
306	12.1	8417	1892	4.4	2.98	3	3	2
357	14.1	9821	2208	5.2	3.48	3	3	2
408	16.1	11224	2523	5.9	3.98	3	3	2
459	18.1	12627	2839	6.7	4.47	4	4	2
510	20.1	14031	3154	7.4	4.97	4	4	2
561	22.1	15434	3470	8.1	5.47	4	4	2
612	24.1	16837	3785	8.9	5.97	5	5	3
663	26.1	18240	4100	9.6	6.46	5	5	3

Additional standard belt widths are available in steps of 51.0 mm (2.01 in).

1989	78.3	54698	12296	28.8	19.38	14	14	7
------	------	-------	-------	------	-------	----	----	---

Additional standard belt widths are available in steps of 51.0 mm (2.01 in).

2958	116.5	81345	18286	42.9	28.82	20	20	10
------	-------	-------	-------	------	-------	----	----	----

General belt tolerance is +0/-0.4% at 23°C/73°F and 50% RH. For exact belt width contact Customer Service. Non standard belt width on request.

\*Max. Load per Drive Sprocket. Belt material: POM-S 2000 N (450 lbf).

\*\*Max. Spacing between wear strips, Carry: 152.0 mm (6.00 in); Return: 304.0 mm (12.00 in).

= Single Link



STANDARD

STRAIGHT RUNNING

PITCH 50.8 MM/2.00 IN

## Sprocket

No. of teeth	Bore size									Overall diameter		Pitch-diameter		Hub-diameter		Dimension A		Dimension B		Single row/One way	Molded	Machined
	Pilot bore																					
	mm	in	1.00	1.18	1.25	1.50	1.57	2.36	2.50	mm	in	mm	in	mm	in	mm	in					
Z08	✓		●	●	●	■	●			132.9	5.23	132.8	5.23	65.0	2.56	53.3	2.10	74.6	2.93	✓	✓	
Z10	✓			●	●	●	■	●		166.3	6.55	164.4	6.47	65.0	2.56	70.2	2.76	90.4	3.56	✓	✓	
Z10								■	■	166.3	6.55	164.4	6.47	120.0	4.72	70.2	2.76	90.4	3.56	✓	✓	
Z12	✓			●	●	●	■	●		198.6	7.82	196.3	7.73	65.0	2.56	86.8	3.42	106.3	4.18	✓	✓	
Z12								■	■	198.6	7.82	196.3	7.73	120.0	4.72	86.8	3.42	106.3	4.18	✓	✓	
Z16	✓			●	●	●	■	■	■	263.8	10.39	260.4	10.25	150.0	5.90	119.7	4.71	138.3	5.44	✓		✓

● Molded sprocket

■ Machined sprocket



Other sprocket sizes are available upon request.

Other bore sizes on sprockets are available upon request.

Round bores are always delivered with keyway.

Max. load per sprocket shown does not take bore size into account.

Please also ensure that sufficient size shaft is chosen for corresponding load.

Width of tooth = Single row 9.5 mm (0.37 in)

Width of One-part sprocket = Single row: 42.3 mm (1.67 in)

## uni UltraClean Two-Part Sprocket

No. of teeth	Bore size				Overall diameter		Pitch-diameter		Hub-diameter		Dimension A		Dimension B		Single row/One way	Moulded
	in	1.50	1.57	2.36												
	mm	38.1	40.0	60.0	mm	in	mm	in	mm	in	mm	in	mm	in		
Z8		■	■		132.9	5.23	132.8	5.23	80.0	3.15	53.3	2.10	74.9	2.94	✓	✓
Z10		1 ■	1 ■	2 ■	166.3	6.55	164.4	6.47	<sup>1</sup> 126.0 <sup>2</sup> 118.0	<sup>1</sup> 4.96 <sup>2</sup> 4.65	70.2	2.76	90.7	3.57	✓	✓
Z12		1 ■	1 ■	2 ■	198.6	7.82	196.3	7.73	<sup>1</sup> 126.0 <sup>2</sup> 118.0	<sup>1</sup> 4.96 <sup>2</sup> 4.65	86.8	3.42	106.6	4.19	✓	✓

■ Moulded uni UltraClean TwoPart Sprocket

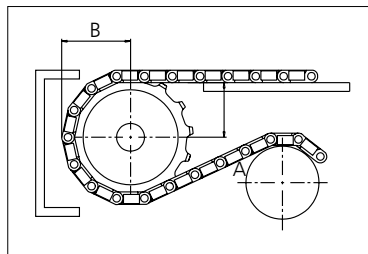

Width of UltraClean Two-part sprocket = Single row: 44.0 mm (1.73 in)

Width of UltraClean Two-part sprocket, tooth = Single row: 9.5 mm (0.37 in)

uni Retainer Rings: See uni Retainer Ring data sheet.

For correct sprocket position: See uni Assembly Instructions for uni RTB.

For more detailed sprocket information, contact Customer Service.

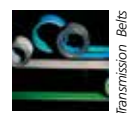

Expert advice, quality solutions and local service for all your belting needs  
[www.ammeraalbeltech.com](http://www.ammeraalbeltech.com)

**Ammeraal Beltech Modular A/S**  
Hjulgagervej 21  
DK-7100 Vejle

T +45 7572 3100  
F +45 7572 3348  
admin@unichains.com  
www.unichains.com

This information is subject to alteration due to continuous development. Ammeraal Beltech will not be held liable for the incorrect use of the above stated information. This information replaces previous information. All activities performed and services rendered by Ammeraal Beltech are subject to general terms and conditions of sale and delivery, as applied by its operating companies.



# Plastic Modular Belt

Series **uni RTB** Type **M2**

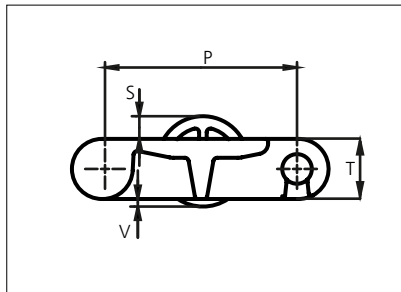

Straight running belt  
 Nominal pitch: 50.8 mm (2.00 in)  
 Surface type: Roller Top  
 Surface opening: Closed  
 Backflex radius: 65.0 mm (2.56 in)  
 uni Snap link (pinless)

<b>Belt material &amp; color</b>	POM-S <b>B</b>
<b>Roller material &amp; color</b>	POM-NL <b>O</b>
<b>Cover plate material &amp; color</b>	POM-NL <b>O</b>
<b>Pin for roller material &amp; color</b>	<b>SS304</b>

	mm	in		mm	in
<b>P (Nominal)</b>	50.8	2.00	<b>T</b>	16.0	0.63
<b>S</b>	6.0	0.24	<b>V</b>	2.0	0.08

**Roller Positions**

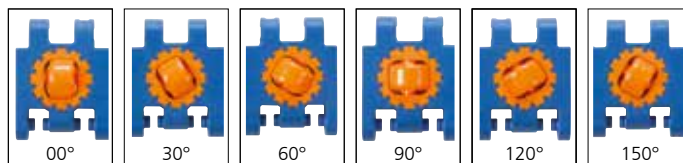

Non standard material and color: See uni Material and Color Overview.

Belt width		Permissible tensile force (Belt/pin material)		Belt weight (Belt/pin material)		*Min. No. drive sprocket per shaft	Number of wear strips (Min. No.)	
		POM-S		POM-S			**Carry (pcs)	**Return (pcs)
mm	in	N	lbf	kg/m	lb/ft			
153	6.0	4208	946	2.2	1.49	2	2	2
204	8.0	5611	1261	3.0	1.99	2	2	2
255	10.0	7014	1577	3.7	2.49	2	2	2
306	12.1	8417	1892	4.4	2.98	3	3	2
357	14.1	9821	2208	5.2	3.48	3	3	2
408	16.1	11224	2523	5.9	3.98	3	3	2
459	18.1	12627	2839	6.7	4.47	4	4	2
510	20.1	14031	3154	7.4	4.97	4	4	2
561	22.1	15434	3470	8.1	5.47	4	4	2
612	24.1	16837	3785	8.9	5.97	5	5	3
663	26.1	18240	4100	9.6	6.46	5	5	3

Additional standard belt widths are available in steps of 51.0 mm (2.01 in).

1989	78.3	54698	12296	28.8	19.38	14	14	7
------	------	-------	-------	------	-------	----	----	---

Additional standard belt widths are available in steps of 51.0 mm (2.01 in).

2958	116.5	81345	18286	42.9	28.82	20	20	10
------	-------	-------	-------	------	-------	----	----	----

General belt tolerance is +0/-0.4% at 23°C/73°F and 50% RH. For exact belt width contact Customer Service. Non standard belt width on request.

\*Max. Load per Drive Sprocket. Belt material: POM-S 2000 N (450 lbf).

\*\*Max. Spacing between wear strips, Carry: 152.0 mm (6.00 in); Return: 304.0 mm (12.00 in).

= Single Link



STANDARD

STRAIGHT RUNNING

PITCH 50.8 MM/2.00 IN

## Sprocket

No. of teeth	Bore size									Overall diameter		Pitch-diameter		Hub-diameter		Dimension A		Dimension B		Single row/One way	Molded	Machined
	Pilot bore																					
	mm	in	1.00	1.18	1.25	1.50	1.57	2.36	2.50	mm	in	mm	in	mm	in	mm	in					
Z08	✓		●	●	●	■	●			132.9	5.23	132.8	5.23	65.0	2.56	53.3	2.10	74.6	2.93	✓	✓	
Z10	✓			●	●	●	■	■		166.3	6.55	164.4	6.47	65.0	2.56	70.2	2.76	90.4	3.56	✓	✓	
Z10								■	■	166.3	6.55	164.4	6.47	120.0	4.72	70.2	2.76	90.4	3.56	✓	✓	
Z12	✓			●	●	●	■	■		198.6	7.82	196.3	7.73	65.0	2.56	86.8	3.42	106.3	4.18	✓	✓	
Z12								■	■	198.6	7.82	196.3	7.73	120.0	4.72	86.8	3.42	106.3	4.18	✓	✓	
Z16	✓			●	●	●	■	■	■	263.8	10.39	260.4	10.25	150.0	5.90	119.7	4.71	138.3	5.44	✓		✓

● Molded sprocket

■ Machined sprocket



Other sprocket sizes are available upon request.

Other bore sizes on sprockets are available upon request.

Round bores are always delivered with keyway.

Max. load per sprocket shown does not take bore size into account.

Please also ensure that sufficient size shaft is chosen for corresponding load.

Width of tooth = Single row 9.5 mm (0.37 in)

Width of One-part sprocket = Single row: 42.3 mm (1.67 in)

## uni UltraClean Two-Part Sprocket

No. of teeth	Bore size				Overall diameter		Pitch-diameter		Hub-diameter		Dimension A		Dimension B		Single row/One way	Moulded
	in	1.50	1.57	2.36												
	mm	38.1	40.0	60.0	mm	in	mm	in	mm	in	mm	in	mm	in		
Z8		■	■		132.9	5.23	132.8	5.23	80.0	3.15	53.3	2.10	74.9	2.94	✓	✓
Z10		1 ■	1 ■	2 ■	166.3	6.55	164.4	6.47	<sup>1</sup> 126.0 <sup>2</sup> 118.0	<sup>1</sup> 4.96 <sup>2</sup> 4.65	70.2	2.76	90.7	3.57	✓	✓
Z12		1 ■	1 ■	2 ■	198.6	7.82	196.3	7.73	<sup>1</sup> 126.0 <sup>2</sup> 118.0	<sup>1</sup> 4.96 <sup>2</sup> 4.65	86.8	3.42	106.6	4.19	✓	✓

■ Moulded uni UltraClean TwoPart Sprocket

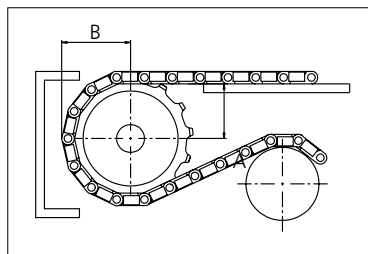

Width of UltraClean Two-part sprocket = Single row: 44.0 mm (1.73 in)

Width of UltraClean Two-part sprocket, tooth = Single row: 9.5 mm (0.37 in)

uni Retainer Rings: See uni Retainer Ring data sheet.

For correct sprocket position: See uni Assembly Instructions for uni RTB.

For more detailed sprocket information. contact Customer Service.



Expert advice, quality solutions and local service for all your belting needs  
[www.ammeraalbeltech.com](http://www.ammeraalbeltech.com)

**Ammeraal Beltech Modular A/S**  
Hjulgagervej 21  
DK-7100 Vejle

T +45 7572 3100  
F +45 7572 3348  
admin@unichains.com  
www.unichains.com

This information is subject to alteration due to continuous development. Ammeraal Beltech will not be held liable for the incorrect use of the above stated information. This information replaces previous information. All activities performed and services rendered by Ammeraal Beltech are subject to general terms and conditions of sale and delivery, as applied by its operating companies.





# Plastic Modular Belt

Series **uni RTB** Type **M1 8% Open**

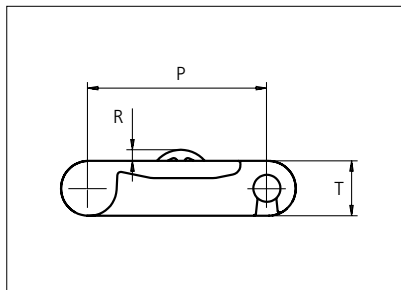

Straight running belt  
 Nominal pitch: 50.8 mm (2.00 in)  
 Surface type: Roller Top  
 Surface opening: 8%  
 Backflex radius: 65.0 mm (2.56 in)  
 uni Snap link (pinless)

<b>Belt material &amp; color</b>	PA6.6 <b>DG</b>
<b>Roller material &amp; color</b>	PA6.6 <b>DG</b>
<b>Pin for roller material &amp; color</b>	<b>SS304</b>

	<b>mm</b>	<b>in</b>		<b>mm</b>	<b>in</b>
<b>P (Nominal)</b>	50.8	2.00	<b>T</b>	16.0	0.63
<b>R</b>	3.0	0.12	-	-	-

**Roller Positions**

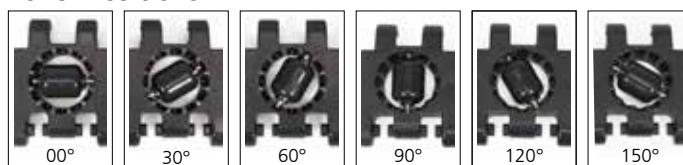

Non standard material and color: See uni Material and Color Overview.

Belt width		Permissible tensile force (Belt/pin material)		Belt weight (Belt/pin material)		*Min. No. drive sprocket per shaft	Number of wear strips (Min. No.)	
		PA6.6		PA6.6			**Carry (pcs)	**Return (pcs)
mm	in	N	lbf	kg/m	lb/ft			
154	6.1	4235	952	2.2	1.50	2	2	2
205	8.1	5638	1267	3.0	2.00	2	2	2
256	10.1	7040	1583	3.7	2.49	2	2	2
307	12.1	8443	1898	4.5	2.99	3	3	2
358	14.1	9845	2213	5.2	3.49	3	3	2
409	16.1	11248	2528	5.9	3.99	3	3	2
460	18.1	12650	2844	6.7	4.48	4	4	2
511	20.1	14053	3159	7.4	4.98	4	4	2
563	22.2	15483	3480	8.2	5.49	4	4	2
614	24.2	16885	3796	8.9	5.98	5	5	3
665	26.2	18288	4111	9.6	6.48	5	5	3

Additional standard belt widths are available in steps of 51.0 mm (2.01 in).

1993	78.5	54808	12321	28.9	19.42	14	14	7
------	------	-------	-------	------	-------	----	----	---

Additional standard belt widths are available in steps of 51.0 mm (2.01 in).

2964	116.7	81510	18323	43.0	28.88	20	20	10
------	-------	-------	-------	------	-------	----	----	----

General belt tolerance is +0/-0.4% at 23°C/73°F and 50% RH. For exact belt width contact Customer Service. Non standard belt width on request.

\*Max. Load per Drive Sprocket. Belt material: PA6.6 2000 N (450 lbf).

\*\*Max. Spacing between wear strips, Carry: 152.0 mm (6.00 in); Return: 304.0 mm (12.00 in).

= Single Link



STANDARD

STRAIGHT RUNNING

PITCH 50.8 MM/2.00 IN

## Sprocket

No. of teeth	Bore size									Overall diameter		Pitch-diameter		Hub-diameter		Dimension A		Dimension B		Single row/One way	Molded	Machined
	Pilot bore																					
	mm	25.4	30.0	31.8	38.1	40.0	60.0	63.5	mm	in	mm	in	mm	in	mm	in	mm	in				
Z08	✓	●	●	●	■	●			132.9	5.23	132.8	5.23	65.0	2.56	53.3	2.10	74.6	2.93	✓	✓		
Z10	✓		●	●	■	●			166.3	6.55	164.4	6.47	65.0	2.56	70.2	2.76	90.4	3.56	✓	✓		
Z10							■	■	166.3	6.55	164.4	6.47	120.0	4.72	70.2	2.76	90.4	3.56	✓	✓		
Z12	✓		●	●	■	●			198.6	7.82	196.3	7.73	65.0	2.56	86.8	3.42	106.3	4.18	✓	✓		
Z12							■	■	198.6	7.82	196.3	7.73	120.0	4.72	86.8	3.42	106.3	4.18	✓	✓		
Z16	✓		●	●	■	●	■	■	263.8	10.39	260.4	10.25	150.0	5.90	119.7	4.71	138.3	5.44	✓		✓	

● Molded sprocket

■ Machined sprocket



Other sprocket sizes are available upon request.

Other bore sizes on sprockets are available upon request.

Round bores are always delivered with keyway.

Max. load per sprocket shown does not take bore size into account.

Please also ensure that sufficient size shaft is chosen for corresponding load.

Width of tooth = Single row 9.5 mm (0.37 in)

Width of One-part sprocket = Single row: 42.3 mm (1.67 in)

## uni UltraClean Two-Part Sprocket

No. of teeth	Bore size				Overall diameter		Pitch-diameter		Hub-diameter		Dimension A		Dimension B		Single row/One way	Moulded
	in	1.50	1.57	2.36												
	mm	38.1	40.0	60.0	mm	in	mm	in	mm	in	mm	in	mm	in		
Z8		■	■		132.9	5.23	132.8	5.23	80.0	3.15	53.3	2.10	74.9	2.94	✓	✓
Z10		1 ■	1 ■	2 ■	166.3	6.55	164.4	6.47	<sup>1</sup> 126.0 <sup>2</sup> 118.0	<sup>1</sup> 4.96 <sup>2</sup> 4.65	70.2	2.76	90.7	3.57	✓	✓
Z12		1 ■	1 ■	2 ■	198.6	7.82	196.3	7.73	<sup>1</sup> 126.0 <sup>2</sup> 118.0	<sup>1</sup> 4.96 <sup>2</sup> 4.65	86.8	3.42	106.6	4.19	✓	✓

■ Moulded uni UltraClean TwoPart Sprocket

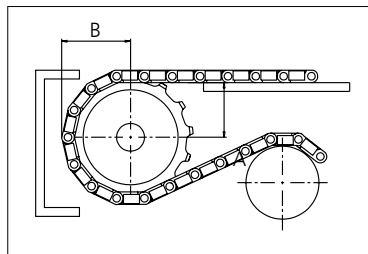

Width of UltraClean Two-part sprocket = Single row: 44.0 mm (1.73 in)

Width of UltraClean Two-part sprocket, tooth = Single row: 9.5 mm (0.37 in)

uni Retainer Rings: See uni Retainer Ring data sheet.

For correct sprocket position: See uni Assembly Instructions for uni RTB.

For more detailed sprocket information, contact Customer Service.



Conveyor Belts



Seamless Belts



Modular Belts



Timing Belts



Transmission Belts



Fabrication & service

Expert advice, quality solutions and local service for all your belting needs  
[www.ammeraalbeltech.com](http://www.ammeraalbeltech.com)

**Ammeraal Beltech Modular A/S**  
Hjulgagervej 21  
DK-7100 Vejle

T +45 7572 3100  
F +45 7572 3348  
admin@unichains.com  
www.unichains.com

This information is subject to alteration due to continuous development. Ammeraal Beltech will not be held liable for the incorrect use of the above stated information. This information replaces previous information. All activities performed and services rendered by Ammeraal Beltech are subject to general terms and conditions of sale and delivery, as applied by its operating companies.



# Plastic Modular Belt

Series **uni S-MPB** Type **C**

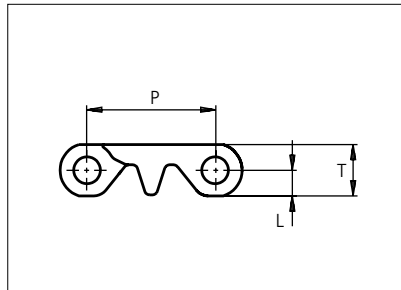

Straight running belt  
 Nominal pitch: 25.4 mm (1.00 in)  
 Surface type: Flat  
 Surface opening: Closed  
 Backflex radius: 23.0 mm (0.91 in)  
 Pin diameter: 5.0 mm (0.20 in)

Belt material & color	POM-DI <span style="border: 1px solid black; padding: 0 2px;">W</span>	PP <span style="border: 1px solid black; padding: 0 2px;">W</span>	POM-DI <span style="border: 1px solid black; padding: 0 2px;">B</span>	PP <span style="border: 1px solid black; padding: 0 2px;">B</span>	PE-I <span style="border: 1px solid black; padding: 0 2px;">B</span> <span style="border: 1px solid black; padding: 0 2px;">N</span>	mm	in	T	mm	in
Pin material & color	PP <span style="border: 1px solid black; padding: 0 2px;">W</span>		PP <span style="border: 1px solid black; padding: 0 2px;">B</span>		PE <span style="border: 1px solid black; padding: 0 2px;">N</span>	L	5.2	0.20	-	-

Non standard material and color: See uni Material and Color Overview.

Alternative pin and lock materials: Lockpin: PBT LG PA6.6 N D

Belt width		Permissible tensile force (Belt/pin material)						Belt weight (Belt/pin material)						*Min. No. drive sprocket per shaft	Number of wear strips (Min. No.)	
		POM-DI/PP		PP/PP		PE-I/PP		POM-DI/PP		PP/PP		PE-I/PP			**Carry (pcs)	**Return (pcs)
mm	in	N	lbf	N	lbf	N	lbf	kg/m	lb/ft	kg/m	lb/ft	kg/m	lb/ft			
77	3.0	1810	407	732	164	604	136	0.6	0.43	0.4	0.29	0.4	0.29	2	2	2
153	6.0	3596	808	1454	327	1201	270	1.3	0.85	0.9	0.58	0.9	0.59	2	2	2
184	7.2	4317	971	1745	392	1442	324	1.5	1.02	1.0	0.69	1.0	0.70	2	2	2
229	9.0	5382	1210	2176	489	1798	404	1.9	1.28	1.3	0.86	1.3	0.88	2	2	2
305	12.0	7168	1611	2898	651	2394	538	2.5	1.70	1.7	1.15	1.7	1.17	3	3	2
381	15.0	8954	2013	3620	814	2991	672	3.2	2.13	2.1	1.43	2.2	1.46	3	3	2
457	18.0	10740	2414	4342	976	3588	806	3.8	2.55	2.6	1.72	2.6	1.75	4	4	2
507	20.0	11910	2677	4815	1082	3978	894	4.2	2.83	2.8	1.91	2.9	1.94	4	4	2
533	21.0	12527	2816	5064	1138	4184	941	4.4	2.97	3.0	2.01	3.0	2.04	4	4	2
609	24.0	14313	3218	5786	1301	4781	1075	5.1	3.40	3.4	2.29	3.5	2.33	5	5	3
685	27.0	16100	3619	6508	1463	5378	1209	5.7	3.82	3.8	2.58	3.9	2.62	5	5	3
761	30.0	17886	4021	7231	1625	5975	1343	6.3	4.25	4.3	2.86	4.3	2.92	6	6	3
837	33.0	19673	4422	7953	1788	6571	1477	6.9	4.67	4.7	3.15	4.8	3.21	6	6	3

Additional standard belt widths are available in steps of 76.0 mm (2.99 in). Additional non-standard belt widths are available in steps of 12.7 mm (0.50 in).

1977	77.8	46460	10444	18782	4222	15519	3489	16.4	11.03	11.1	7.44	11.3	7.57	14	14	7
------	------	-------	-------	-------	------	-------	------	------	-------	------	------	------	------	----	----	---

Additional standard belt widths are available in steps of 76.0 mm (2.99 in). Additional non-standard belt widths are available in steps of 12.7 mm (0.50 in).

2965	116.7	69678	15664	28168	6332	23275	5232	24.6	16.54	16.6	11.16	16.9	11.36	20	20	10
------	-------	-------	-------	-------	------	-------	------	------	-------	------	-------	------	-------	----	----	----

General belt tolerance is +0/-0.4% at 23°C/73°F and 50% RH. For exact belt width contact Customer Service. Non standard belt width on request.

\*Max. Load per Drive Sprocket. Belt material: POM-DI 1100 N (247 lbf), PP 500 N (112 lbf), PE 500 N (112 lbf).

\*\*Max. Spacing between wear strips, Carry: 152.0 mm (6.00 in); Return: 304.0 mm (12.00 in).

= Single Link



STANDARD

STRAIGHT RUNNING

PITCH 25.4 MM/1.00 IN

## Accessories

### Rubber Top

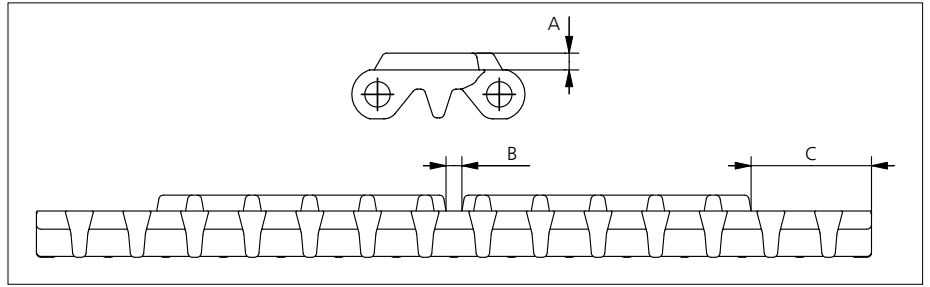

Type	Belt material & color	Rubber material & color	A		B		C		Link size	Width	
			mm	in	mm	in	mm	in		mm	in
Flat	PP <b>B</b>	03 <b>K</b>	3.5	0.14	3.5	0.14	26.5	1.04	K725	184.2	7.25

Non Standard material and color: See uni Material and Color Overview.

## Accessories

### Flight

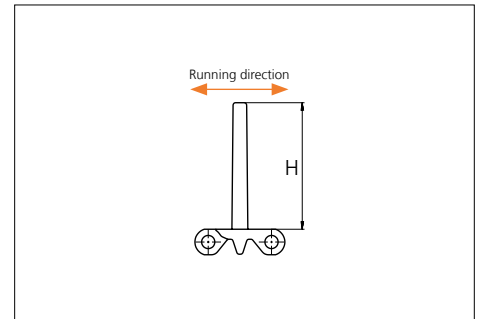
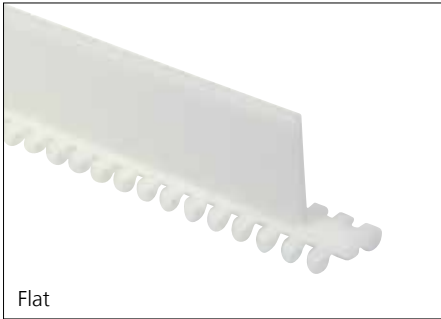

Type	Material & color	H		Link size	Width		Indent both sides	
		mm	in		mm	in	mm	in
13% Non Stick	POM-DI <b>W</b> <b>B</b>	76.2	3.00	K600	151.9	5.98	00.0	0.00
Flat	PP-I <b>W</b> <b>B</b> PE-I <b>N</b> <b>B</b>	50.8	2.00	K2000	506.7	19.95	25.8	1.02

## Accessories

### Side Guard

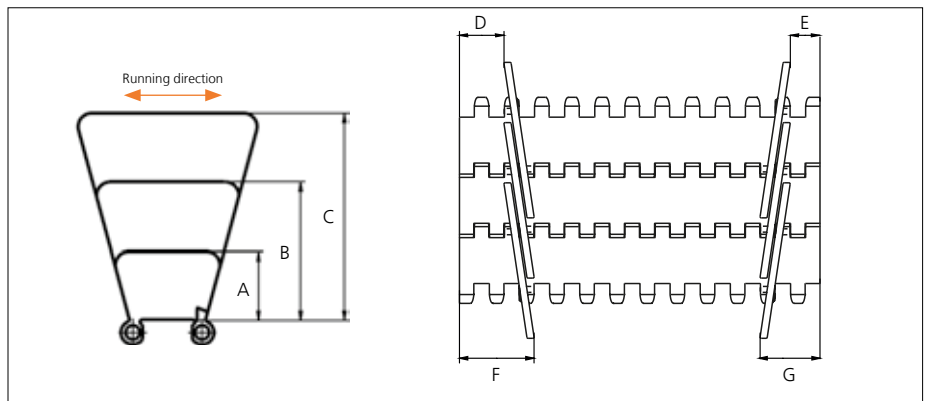

Type	Material & color	A		B		C		D		E		F		G	
		mm	in	mm	in	mm	in	mm	in	mm	in	mm	in	mm	in
Closed	PP-I <b>W</b> <b>B</b>	25.4	1.00	50.8	2.00	76.2	3.00	18.7	0.74	12.5	0.49	31.5	1.24	25.3	1.00

Minimum indent to outside of side guide: 14.0 mm (0.55 in). Increment 6.4 mm (0.25).

Non Standard material and color: See uni Material and Color Overview.

Backflex radius for Side Guide: 75.0 mm (2.95 in).

### Accessories

#### Tab

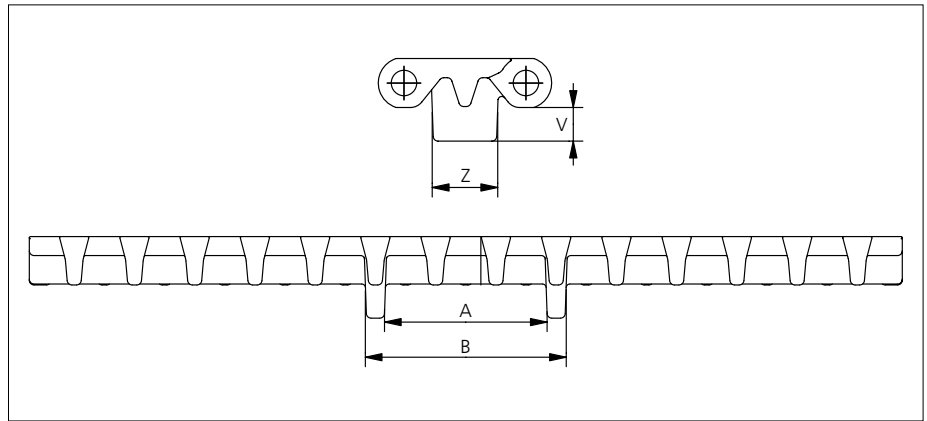
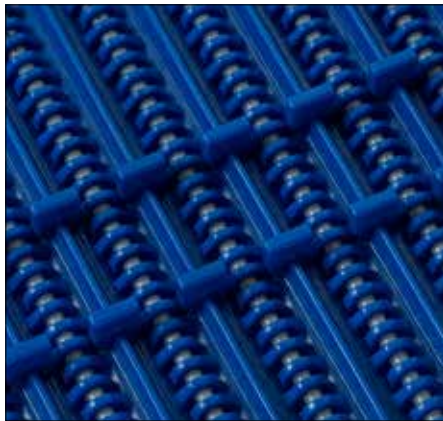

Type	Belt material & color	V		Z		A		B		Link size	Width	
		mm	in	mm	in	mm	in	mm	in		mm	in
Bottom Guide	POM-DI <b>W</b> PP <b>W B</b>	7.0	0.28	13.9	0.55	33.4	1.31	42.8	1.69	K725	184.2	7.25

Non Standard material and color: See uni Material and Color Overview.

### Accessories

#### AmFlight

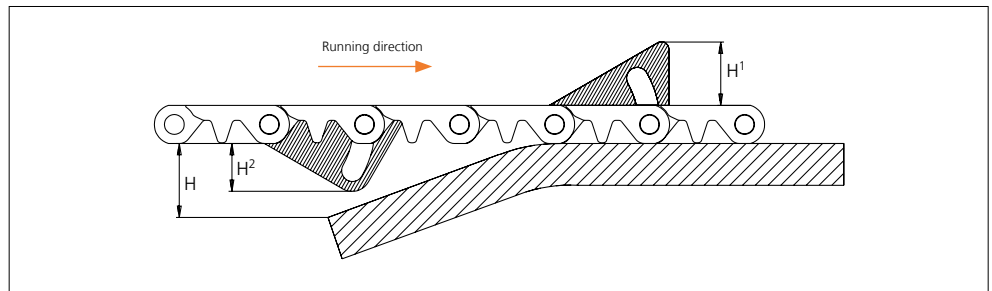

Type	Material & color	H		H <sup>1</sup>		H <sup>2</sup>	
		mm	in	mm	in	mm	in
Push	PE <b>W</b>	17.0	0.67	17.0	0.67	13.3	0.52

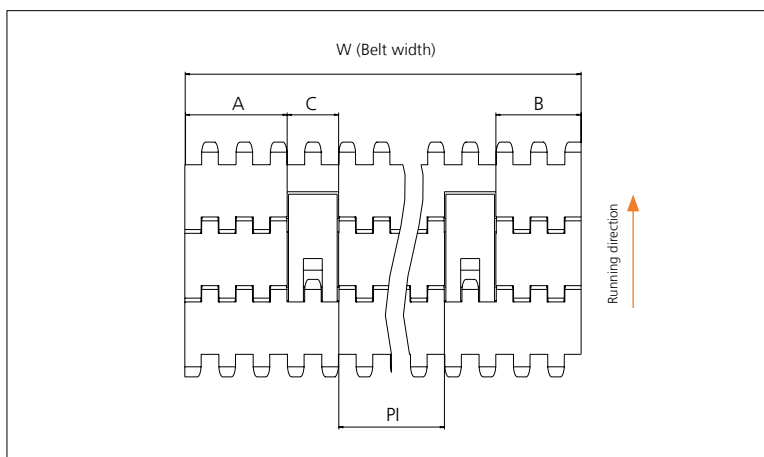

	mm	in
<b>A min</b>	38.4	1.51
<b>B min</b>	32.1	1.26
<b>C</b>	18.0	0.71
<b>PI max</b>	W - 106.5	W - 4.19
<b>PI min</b>	32.8	1.29

Increment: 12.7 mm (0.50 in).

## Sprocket

No. of teeth	Bore size										Overall diameter		Pitch-diameter		Hub-diameter		Dimension A		Dimension B		Double row/Two way	Molded PA6 LG	Machined PA6 N
	Pilot bore		0.75	0.78	1.00	1.18	1.25	1.50	1.57	2.36													
	mm	in																					
Z06	✓	●	●								48.9	1.92	50.8	2.00	33.0	1.30	16.9	0.67	30,75	1.21	✓	✓	
Z08	✓			●	●	●					65.6	2.58	66.4	2.61	50.0	1.97	25.6	1.01	38,53	1.51	✓		✓
Z10	✓			●	●	●		●			82.2	3.23	82.2	3.24	66.0	2.60	34.0	1.34	46,44	1.82	✓	✓	
Z12	✓			●	●	●		●	■		98.6	3.88	98.1	3.86	70.0	2.76	42.3	1.67	54,42	2.14	✓	✓	
Z15	✓			●	●	●	■	●	■	■	123.1	4.84	122.2	4.81	100.0	3.94	54.54	2.15	66.43	2.62	✓	✓	
Z20	✓			●	●	●	■	●	■	■	163.8	6.44	162.4	6.39	100.0	3.94	75.08	2.96	86.53	3.41	✓	✓	

### Molded sprocket



### Machined sprocket

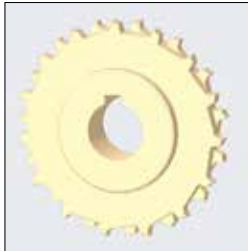

Other sprocket sizes are available upon request.  
 Other bore sizes on sprockets are available upon request.  
 Round bores are always delivered with keyway.  
 Max. load per sprocket shown does not take bore size into account.  
 Please also ensure that sufficient size shaft is chosen for corresponding load.

Width of tooth = Single row: 6.35 mm (0.25 in)  
 = Double row: 12.7 mm (0.50 in)

Width of One-part sprocket = Double row: 25.0 mm (0.98 in)

## uni UltraClean Two-Part Sprocket

No. of teeth	Bore size		Overall diameter		Pitch-diameter		Hub-diameter		Dimension A		Dimension B		Single row/One way	Moulded PA6 W
	in	1.57												
	mm	40.0												
Z12	■		98.6	3.88	98.1	3.86	80.0	3.15	42.3	1.67	54.42	2.14	✓	✓
Z15	■		123.1	4.84	122.2	4.81	80.0	3.15	54.54	2.15	66.43	2.62	✓	✓
Z20	■		163.8	6.44	162.4	6.39	118.0	4.65	75.08	2.96	86.53	3.41	✓	✓

### Moulded uni UltraClean TwoPart Sprocket

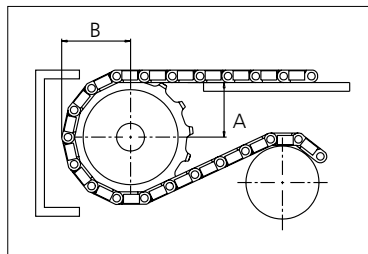

Width of UltraClean Two-part sprocket = Single row: 44.0 mm (1.73 in)  
 Width of UltraClean Two-part tooth = Single row: 6.35 mm (0.25 in)

uni Retainer Rings: See uni Retainer Ring data sheet.  
 For correct sprocket position: See uni Assembly Instructions for uni S-MPB.  
 For more detailed sprocket information, contact Customer Service.

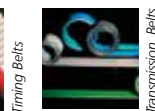

Expert advice, quality solutions and local service for all your belting needs  
[www.ammeraalbeltech.com](http://www.ammeraalbeltech.com)

**Ammeraal Beltech Modular A/S**  
 Hjulmagervej 21  
 DK-7100 Vejle

T +45 7572 3100  
 F +45 7572 3348  
 admin@unichains.com  
 www.unichains.com

This information is subject to alteration due to continuous development. Ammeraal Beltech will not be held liable for the incorrect use of the above stated information. This information replaces previous information. All activities performed and services rendered by Ammeraal Beltech are subject to general terms and conditions of sale and delivery, as applied by its operating companies.



# Plastic Modular Belt

Series **uni S-MPB** Type **22% CS**

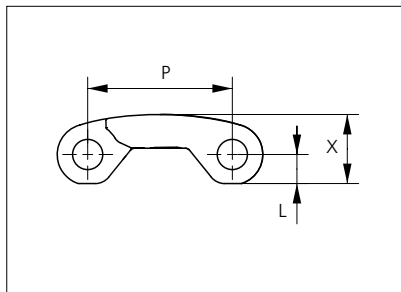

Straight running belt  
 Nominal pitch: 25.4 mm (1.00 in)  
 Surface type: Curved Surface  
 Surface opening: 22%  
 Backflex radius: 23.0 mm (0.91 in)  
 Pin diameter: 5.0 mm (0.20 in)

Belt material & color	POM-DI <span style="border: 1px solid black; padding: 0 2px;">W</span>	PP <span style="border: 1px solid black; padding: 0 2px;">W</span>	PP <span style="border: 1px solid black; padding: 0 2px;">B</span>	PE-I <span style="border: 1px solid black; padding: 0 2px;">B</span>		mm	in		mm	in
	Pin material & color	PP <span style="border: 1px solid black; padding: 0 2px;">W</span>		PP <span style="border: 1px solid black; padding: 0 2px;">B</span>		PE <span style="border: 1px solid black; padding: 0 2px;">N</span>				
					<b>P (Nominal)</b>	25.4	1.00	<b>X</b>	12.1	0.48
					<b>L</b>	5.2	0.20	-	-	-

Non standard material and color: See uni Material and Color Overview.

Alternative pin and lock materials: Lockpin: PBT LG PA6.6 N D

Belt width		Permissible tensile force (Belt/pin material)						Belt weight (Belt/pin material)						*Min. No. drive sprocket per shaft	Number of wear strips (Min. No.)	
		POM-DI/PP		PP/PP		PE-I/PE		POM-DI/PP		PP/PP		PE-I/PE			**Carry (pcs)	**Return (pcs)
mm	in	N	lbf	N	lbf	N	lbf	kg/m	lb/ft	kg/m	lb/ft	kg/m	lb/ft			
77	3.0	1810	407	732	164	604	136	0.5	0.36	0.4	0.24	0.4	0.24	2	2	2
153	6.0	3596	808	1454	327	1201	270	1.1	0.72	0.7	0.48	0.7	0.48	2	2	2
229	9.0	5383	1210	2176	489	1798	404	1.6	1.08	1.1	0.72	1.1	0.72	2	2	2
305	12.0	7169	1612	2898	652	2395	538	2.1	1.44	1.4	0.96	1.4	0.96	3	3	2
381	15.0	8956	2013	3620	814	2992	672	2.7	1.79	1.8	1.20	1.8	1.20	3	3	2
457	18.0	10742	2415	4343	976	3588	807	3.2	2.15	2.1	1.44	2.1	1.44	4	4	2
533	21.0	12529	2816	5065	1139	4185	941	3.7	2.51	2.5	1.68	2.5	1.68	4	4	2
609	24.0	14315	3218	5787	1301	4782	1075	4.3	2.87	2.9	1.92	2.9	1.92	5	5	3
685	27.0	16102	3620	6509	1463	5379	1209	4.8	3.22	3.2	2.16	3.2	2.16	5	5	3
761	30.0	17888	4021	7231	1626	5975	1343	5.3	3.58	3.6	2.40	3.6	2.40	6	6	3
837	33.0	19675	4423	7954	1788	6572	1477	5.9	3.94	3.9	2.64	3.9	2.64	6	6	3
913	36.0	21461	4824	8676	1950	7169	1612	6.4	4.30	4.3	2.88	4.3	2.88	7	7	4
989	38.9	23248	5226	9398	2113	7766	1746	6.9	4.65	4.6	3.12	4.6	3.12	7	7	4

Additional standard belt widths are available in steps of 76.0 mm (2.99 in). Additional non-standard belt widths are available in steps of 12.7 mm (0.50 in).

1977	77.8	46460	10444	18782	4222	15519	3489	13.8	9.30	9.3	6.24	9.3	6.24	14	14	7
------	------	-------	-------	-------	------	-------	------	------	------	-----	------	-----	------	----	----	---

Additional standard belt widths are available in steps of 76.0 mm (2.99 in). Additional non-standard belt widths are available in steps of 12.7 mm (0.50 in).

2965	116.7	69678	15664	28168	6332	23275	5232	20.8	13.95	13.9	9.37	13.9	9.37	20	20	10
------	-------	-------	-------	-------	------	-------	------	------	-------	------	------	------	------	----	----	----

General belt tolerance is +0/-0.4% at 23°C/73°F and 50% RH. For exact belt width contact Customer Service. Non standard belt width on request.

\*Max. Load per Drive Sprocket. Belt material: POM-DI 1100 N (247 lbf), PP 500 N (112 lbf), PE 500 N (112 lbf).

\*\*Max. Spacing between wear strips, Carry: 152 mm (6 in); Return: 304 mm (12 in).

  = Single Link



STANDARD

STRAIGHT RUNNING

PITCH 25.4 MM/1.00 IN

## Accessories

### Flight

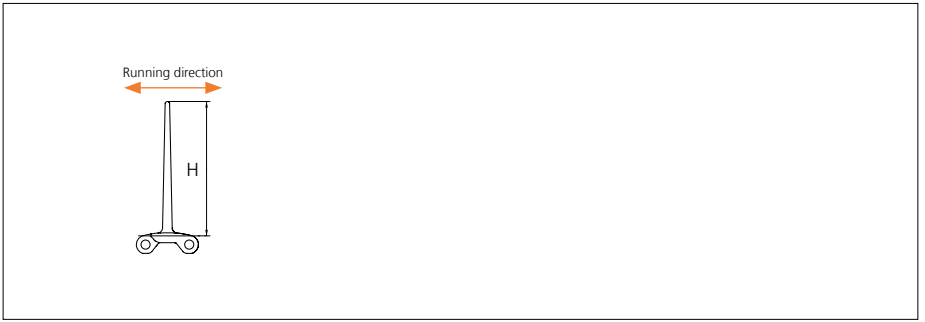
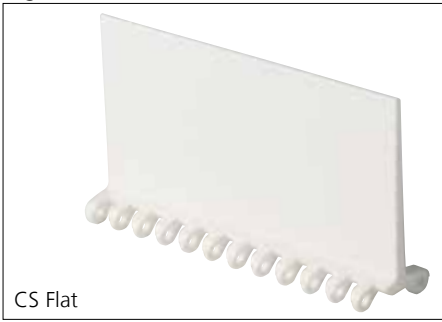

Type	Material & color	H		Link size	Width		Indent both sides	
		mm	in		mm	in	mm	in
CS Flat	POM-D <input type="checkbox"/> W PP-I <input type="checkbox"/> W <input type="checkbox"/> B PE-I <input type="checkbox"/> N <input type="checkbox"/> B	76.2	3.00	K600	151.9	5.98	00.0	0.00



## Sprocket

No. of teeth	Bore size										Overall diameter		Pitch-diameter		Hub-diameter		Dimension A		Dimension B		Double row/Two way	Molded	Machined
	Pilot bore																						
		mm	in	0.75	0.78	1.00	1.18	1.25	1.50	1.57	2.36	mm	in	mm	in	mm	in	mm	in				
Z06	✓		●	●							48.9	1.92	50.8	2.00	33.0	1.30	16.9	0.67	30,75	1.21	✓	✓	
Z08	✓				●	●	●				65.6	2.58	66.4	2.61	50.0	1.97	25.6	1.01	38,53	1.51	✓		✓
Z10	✓				●	●	●		●		82.2	3.23	82.2	3.24	66.0	2.60	34.0	1.34	46,44	1.82	✓	✓	
Z12	✓				●	●	●		●		98.6	3.88	98.1	3.86	70.0	2.76	42.3	1.67	54.42	2.14	✓	✓	
Z15	✓				●	●	●	■	■	■	123.1	4.84	122.2	4.81	100.0	3.94	54.54	2.15	66.43	2.62	✓	✓	
Z20	✓					●	●	■	■	■	163.8	6.44	162.4	6.39	100.0	3.94	75.08	2.96	86.53	3.41	✓	✓	

■ Molded sprocket

● Machined sprocket

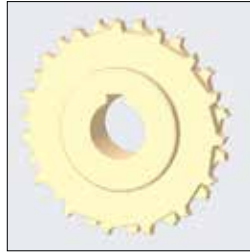

Other sprocket sizes are available upon request.

Other bore sizes on sprockets are available upon request.

Round bores are always delivered with keyway.

Max. load per sprocket shown does not take bore size into account.

Please also ensure that sufficient size shaft is chosen for corresponding load.

Width of tooth = Single row: 6.35 mm (0.25 in)

= Double row: 12.7 mm (0.50 in)

Width of One-part sprocket = Double row: 25.0 mm (0.98 in)

## uni UltraClean Two-Part Sprocket

No. of teeth	Bore size		Overall diameter		Pitch-diameter		Hub-diameter		Dimension A		Dimension B		Single row/One way	Moulded
	in	1.57												
	mm	40.0	mm	in	mm	in	mm	in	mm	in	mm	in		
Z12	■		98.6	3.88	98.1	3.86	80.0	3.15	42.3	1.67	54.42	2.14	✓	✓
Z15	■		123.1	4.84	122.2	4.81	80.0	3.15	54.54	2.15	66.43	2.62	✓	✓
Z20	■		163.8	6.44	162.4	6.39	118.0	4.65	75.08	2.96	86.53	3.41	✓	✓

■ Moulded uni UltraClean TwoPart Sprocket

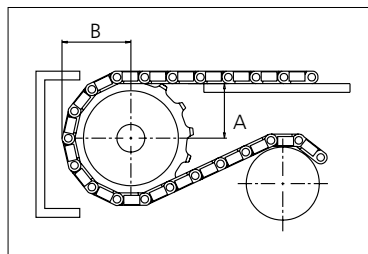

Width of UltraClean Two-part sprocket = Single row: 44.0 mm (1.73 in)

Width of UltraClean Two-part tooth = Single row: 6.35 mm (0.25 in)

uni Retainer Rings: See uni Retainer Ring data sheet.

For correct sprocket position: See uni Assembly Instructions for uni S-MPB.

For more detailed sprocket information, contact Customer Service.



Conveyor Belts



Seamless Belts



Modular Belts



Timing Belts



Transmission Belts



Fabrication & service

Expert advice, quality solutions and local service for all your belting needs  
[www.ammeraalbeltech.com](http://www.ammeraalbeltech.com)

**Ammeraal Beltech Modular A/S**  
Hjulgagervej 21  
DK-7100 Vejle

T +45 7572 3100  
F +45 7572 3348  
admin@unichains.com  
www.unichains.com

This information is subject to alteration due to continuous development. Ammeraal Beltech will not be held liable for the incorrect use of the above stated information. This information replaces previous information. All activities performed and services rendered by Ammeraal Beltech are subject to general terms and conditions of sale and delivery, as applied by its operating companies.



# Plastic Modular Belt

Series **uni S-MPB** Type **N**

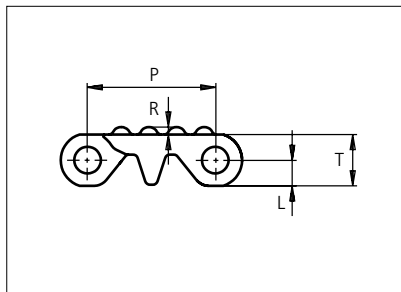

Straight running belt  
 Nominal pitch: 25.4 mm (1.00 in)  
 Surface type: No Cling  
 Surface opening: Closed  
 Backflex radius: 23.0 mm (0.91 in)  
 Pin diameter: 5.0 mm (0.20 in)

<b>Belt material &amp; color</b>	POM-DI <b>W</b>	PE-I <b>B</b>
<b>Pin material &amp; color</b>	PP <b>W</b>	PE <b>N</b>

	mm	in		mm	in
<b>P (Nominal)</b>	25.4	1.00	<b>L</b>	5.20	0.20
<b>R</b>	1.50	0.06	<b>T</b>	10.3	0.41

Non standard material and color: See uni Material and Color Overview.

Alternative pin and lock materials: Lockpin: PBT **LG** PA6.6 **D** **N** PP **B**

\*Single Link K2000 is available with a molded indent of 38.6mm(1.52in) in both sides.

Belt width		Permissible tensile force (Belt/pin material)				Belt weight (Belt/pin material)				*Min. No. drive sprocket per shaft	Number of wear strips (Min. No.)	
		POM-DI/PP		PE-I/PE		POM-DI/PP		PE-I/PE			**Carry (pcs)	**Return (pcs)
mm	in	N	lbf	N	lbf	kg/m	lb/ft	kg/m	lb/ft			
77	3.0	1810	407	604	136	0.6	0.43	0.4	0.29	2	2	2
153	6.0	3596	808	1201	270	1.3	0.85	0.9	0.59	2	2	2
229	9.0	5383	1210	1798	404	1.9	1.28	1.3	0.88	2	2	2
305	12.0	7169	1612	2395	538	2.5	1.70	1.7	1.17	3	3	2
381	15.0	8956	2013	2992	672	3.2	2.13	2.2	1.46	3	3	2
457	18.0	10742	2415	3588	807	3.8	2.55	2.6	1.75	4	4	2
507*	20.0	11910	2677	3978	894	4.2	2.83	2.9	1.94	4	4	2
533	21.0	12529	2816	4185	941	4.4	2.97	3.0	2.04	4	4	2
609	24.0	14315	3218	4782	1075	5.1	3.40	3.5	2.33	5	5	3
685	27.0	16102	3620	5379	1209	5.7	3.82	3.9	2.62	5	5	3
761	30.0	17888	4021	5975	1343	6.3	4.25	4.3	2.92	6	6	3
837	33.0	19675	4423	6572	1477	6.9	4.67	4.8	3.21	6	6	3
913	36.0	21461	4824	7169	1612	7.6	5.09	5.2	3.50	7	7	4

Additional standard belt widths are available in steps of 76.0 mm (2.99 in). Additional non-standard belt widths are available in steps of 12.7 mm (0.50 in).

1977	77.8	46460	10444	15519	3489	16.4	11.03	11.3	7.57	14	14	7
------	------	-------	-------	-------	------	------	-------	------	------	----	----	---

Additional standard belt widths are available in steps of 76.0 mm (2.99 in). Additional non-standard belt widths are available in steps of 12.7 mm (0.50 in).

2965	116.7	69678	15664	23275	5232	24.6	16.54	16.9	11.36	20	20	10
------	-------	-------	-------	-------	------	------	-------	------	-------	----	----	----

General belt tolerance is +0/-0.4% at 23°C/73°F and 50% RH. For exact belt width contact Customer Service. Non standard belt width on request.

\*Max. Load per Drive Sprocket. Belt material: POM-DI 1100 N (247 lbf), PE 500 N (112 lbf).

\*\*Max. Spacing between wear strips, Carry: 152.0 mm (6.00 in); Return: 304.0 mm (12.00 in).

□ = Single Link



STANDARD

STRAIGHT RUNNING

PITCH 25.4 MM/1.00 IN

## Accessories

### Flight

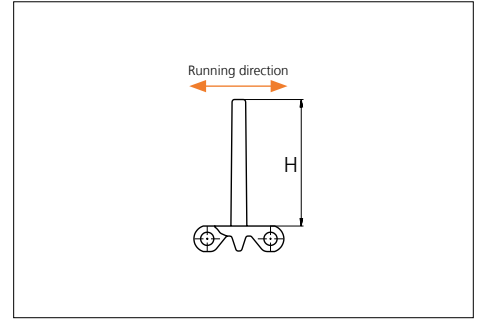
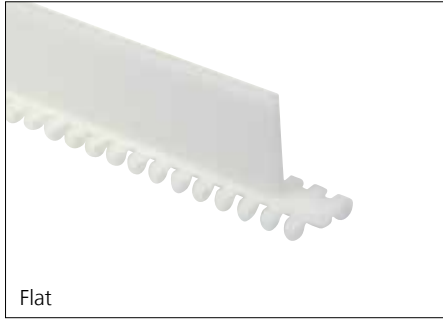

Type	Material & color	H		Link size	Width		Indent both sides	
		mm	in		mm	in	mm	in
13% Non Stick	POM-DI <b>W</b>	76.2	3.00	K600	151.9	5.98	00.0	0.00
Flat	PP-I <b>W</b> <b>B</b>	50.8	2.00	K2000	506.7	19.95	25.8	1.02
	PE-I <b>N</b> <b>B</b>							

## Accessories

### Side Guide

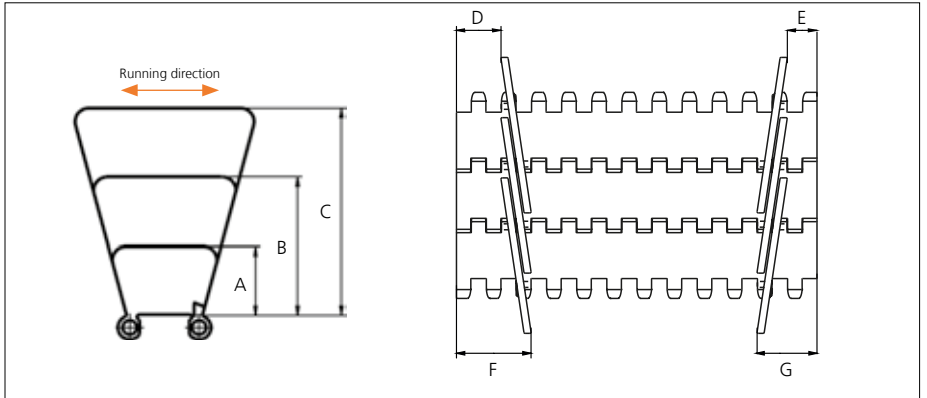

Type	Material & color	A		B		C		D		E		F		G	
		mm	in	mm	in	mm	in	mm	in	mm	in	mm	in	mm	in
Closed	PP-I <b>W</b> <b>B</b>	25.4	1.00	50.8	2.00	76.2	3.00	18.7	0.74	12.5	0.49	31.5	1.24	25.3	1.00

Minimum indent to outside of side guide: 14.0 mm (0.55 in). Increment 6.4 mm (0.25).

Non Standard material and color: See uni Material and Color Overview.

Backflex radius for Side Guide: 75.0 mm (2.95 in).

### Sprocket

No. of teeth	Bore size										Overall diameter		Pitch-diameter		Hub-diameter		Dimension A		Dimension B		Double row/Two way	Molded PA6 LG	Machined PA6
	Pilot bore	in		0.75		0.78		1.00		1.18													
	mm	19.05	20.00	25.40	30.00	31.75	38.10	40.00	60.00	mm	in	mm	in	mm	in	mm	in	mm	in				
Z06	✓	●	●								48.9	1.92	50.8	2.00	33.0	1.30	16.9	0.67	30,75	1.21	✓	✓	
Z08	✓			●	●	●					65.6	2.58	66.4	2.61	50.0	1.97	25.6	1.01	38,53	1.51	✓		✓
Z10	✓			●	●	●		●			82.2	3.23	82.2	3.24	66.0	2.60	34.0	1.34	46,44	1.82	✓	✓	
Z12	✓			●	●	●		●	●		98.6	3.88	98.1	3.86	70.0	2.76	42.3	1.67	54.42	2.14	✓	✓	
Z15	✓			●	●	●	■	●	●	■	123.1	4.84	122.2	4.81	100.0	3.94	54.54	2.15	66.43	2.62	✓	✓	
Z20	✓					●	■	●	●	■	163.8	6.44	162.4	6.39	100.0	3.94	75.08	2.96	86.53	3.41	✓	✓	

■ Molded sprocket

● Machined sprocket



Other sprocket sizes are available upon request.

Other bore sizes on sprockets are available upon request.

Round bores are always delivered with keyway.

Max. load per sprocket shown does not take bore size into account.

Please also ensure that sufficient size shaft is chosen for corresponding load.

Width of tooth = Single row: 6.35 mm (0.25 in)

= Double row: 12.7 mm (0.50 in)

Width of One-part sprocket = Double row: 25.0 mm (0.98 in)

### uni UltraClean Two-Part Sprocket

No. of teeth	Bore size		Overall diameter		Pitch-diameter		Hub-diameter		Dimension A		Dimension B		Single row/One way	Moulded PA6
	in	1.57												
	mm	40.0	mm	in	mm	in	mm	in	mm	in	mm	in		
Z12		■	98.6	3.88	98.1	3.86	80.0	3.15	42.3	1.67	54.42	2.14	✓	✓
Z15		■	123.1	4.84	122.2	4.81	80.0	3.15	54.54	2.15	66.43	2.62	✓	✓
Z20		■	163.8	6.44	162.4	6.39	118.0	4.65	75.08	2.96	86.53	3.41	✓	✓

■ Moulded uni UltraClean TwoPart Sprocket

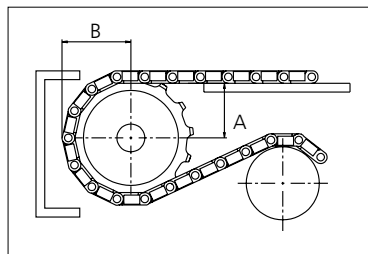

Width of UltraClean Two-part sprocket = Single row: 44.0 mm (1.73 in)

Width of UltraClean Two-part tooth = Single row: 6.35 mm (0.25 in)

uni Retainer Rings: See uni Retainer Ring data sheet.

For correct sprocket position: See uni Assembly Instructions for uni S-MPB.

For more detailed sprocket information, contact Customer Service.



Conveyor Belts



Seamless Belts



Modular Belts



Timing Belts

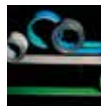

Transmission Belts



Fabrication & service

Expert advice, quality solutions and local service for all your belting needs [www.ammeraalbeltech.com](http://www.ammeraalbeltech.com)

**Ammeraal Beltech Modular A/S**  
Hjulgagervej 21  
DK-7100 Vejle

T +45 7572 3100  
F +45 7572 3348  
admin@unichains.com  
www.unichains.com

This information is subject to alteration due to continuous development. Ammeraal Beltech will not be held liable for the incorrect use of the above stated information. This information replaces previous information. All activities performed and services rendered by Ammeraal Beltech are subject to general terms and conditions of sale and delivery, as applied by its operating companies.



# Plastic Modular Belt

Series **uni SNB** Type **M2 20%**

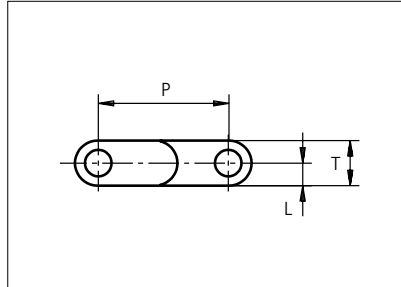
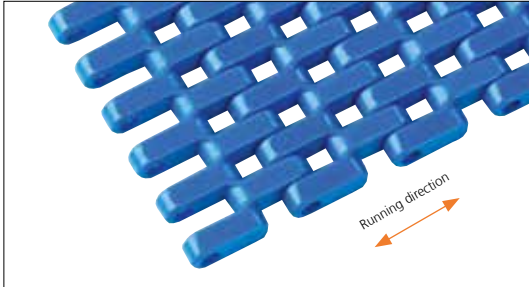

Straight running belt  
 Nominal pitch: 25.4 mm (1.00 in)  
 Surface type: Flat  
 Surface opening: 20%  
 Backflex radius: 30.0 mm (1.20 in)  
 Pin diameter: 5.0 mm (0.20 in)

STANDARD

Belt material & color	POM-D <b>B</b>	PP <b>B</b>	PP <b>W</b>	PE <b>N</b>	PE <b>B</b>	mm	in	mm	in
Pin material & color	PP <b>B</b>		PP <b>W</b>		PE <b>N</b>		P (Nominal)	T <td rowspan="2"></td>	
						25.4			
					8.8	0.35	-	-	-

Non standard material and color: See uni Material and Color Overview.

Alternative pin and lock materials: Lockpin: PBT **LG** PA6.6 **D** **N** PP **B** **W** PE **N**

STRAIGHT RUNNING

Belt width		Permissible tensile force (Belt/pin material)						Belt weight (Belt/pin material)						*Min. No. drive sprocket per shaft	Number of wear strips (Min. No.)	
		POM-D/PA6.6		PP/PA6.6		PE/PA6.6		POM-D/PA6.6		PP/PA6.6		PE/PA6.6			**Carry (pcs)	**Return (pcs)
mm	in	N	lbf	N	lbf	N	lbf	kg/m	lb/ft	kg/m	lb/ft	kg/m	lb/ft			
77	3.0	1810	407	1155	260	770	173	0.5	0.33	0.3	0.22	0.3	0.23	2	2	2
153	6.0	3596	808	2295	516	1530	344	1.0	0.65	0.7	0.44	0.7	0.45	2	2	2
191	7.5	4489	1009	2865	644	1910	429	1.2	0.81	0.8	0.55	0.8	0.56	2	2	2
229	9.0	5382	1210	3435	772	2290	515	1.4	0.97	1.0	0.66	1.0	0.68	2	2	2
305	12.0	7168	1611	4575	1028	3050	686	1.9	1.29	1.3	0.88	1.3	0.90	3	3	2
381	15.0	8954	2013	5715	1285	3810	856	2.4	1.61	1.6	1.10	1.7	1.13	3	3	2
457	18.0	10740	2414	6855	1541	4570	1027	2.9	1.93	2.0	1.32	2.0	1.35	4	4	2
533	21.0	12526	2816	7995	1797	5330	1198	3.4	2.26	2.3	1.54	2.3	1.58	4	4	2
609	24.0	14312	3217	9135	2054	6090	1369	3.8	2.58	2.6	1.76	2.7	1.80	5	5	3
685	27.0	16098	3619	10275	2310	6850	1540	4.3	2.90	2.9	1.98	3.0	2.03	5	5	3
761	30.0	17884	4020	11415	2566	7610	1711	4.8	3.22	3.3	2.20	3.3	2.25	6	6	3
837	33.0	19670	4422	12555	2822	8370	1882	5.3	3.54	3.6	2.42	3.7	2.48	6	6	3
913	35.9	21456	4823	13695	3079	9130	2052	5.8	3.87	3.9	2.64	4.0	2.70	7	7	4

Additional standard belt widths are available in steps of 76.1 mm (3.00 in). Additional non-standard belt widths are available in steps of 12.7 mm (0.50 in).

1978	77.9	46483	10449	29670	6670	19780	4447	12.5	8.37	8.5	5.72	8.7	5.85	14	14	7
------	------	-------	-------	-------	------	-------	------	------	------	-----	------	-----	------	----	----	---

Additional standard belt widths are available in steps of 76.1 mm (3.00 in). Additional non-standard belt widths are available in steps of 12.7 mm (0.50 in).

2967	116.8	69725	15674	44505	10005	29670	6670	18.7	12.56	12.8	8.57	13.1	8.77	20	20	10
------	-------	-------	-------	-------	-------	-------	------	------	-------	------	------	------	------	----	----	----

General belt tolerance is +0/-0.4% at 23°C/73°F and 50% RH. For exact belt width contact Customer Service. Non standard belt width on request.

\*Max. Load per Drive Sprocket. Belt material: POM-D 1400 N (315 lbf), PP 1100 N (247 lbf), PE 1100 N (247 lbf).

\*\*Max. Spacing between wear strips, Carry: 152.0 mm (6.00 in); Return: 304.0 mm (12.00 in).

= Single Link

PITCH 25.4 MM/1.00 IN



## Accessories

### Rubber Top

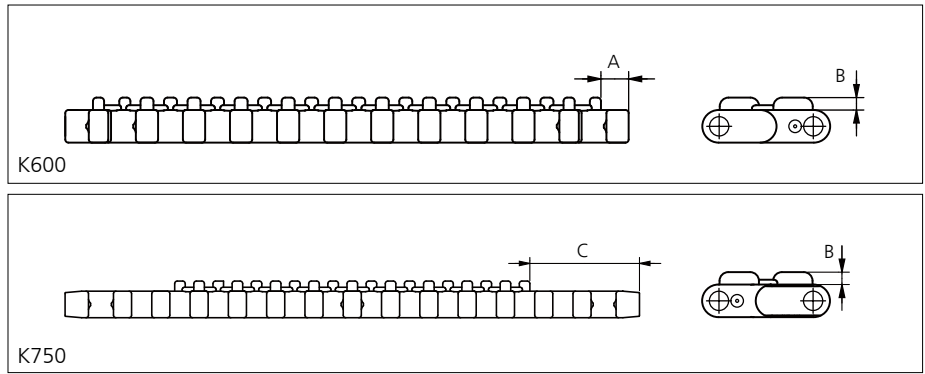
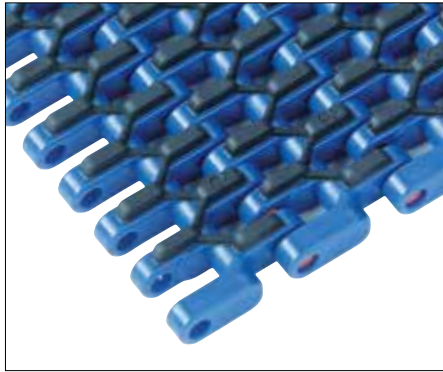

Type	Belt material & color	Rubber material & color	A		B		C		Link size	Width	
			mm	in	mm	in	mm	in		mm	in
M2 20% Flat	PP <b>B</b>	03 <b>K</b>	7.5	0.30	3.4	0.13	36.0	1.41	K300	77.0	3.00
									K600	152.4	6.00
	PP <b>W</b>	03 <b>N</b>							K750	190.5	7.50

## Accessories

### Flight

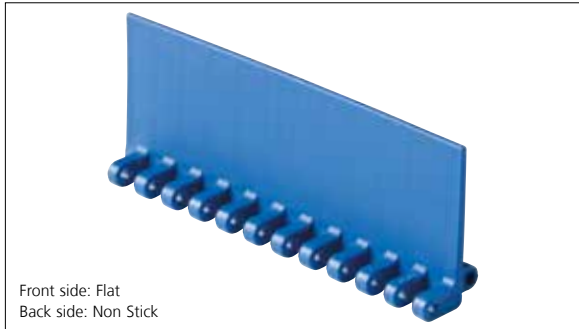

Type	Flight Material & color		H		Link size	Width	
			mm	in		mm	in
M2 20% Flat/Non Stick	PP-I <b>W</b> <b>B</b>	PE <b>N</b> <b>B</b>	5.0	0.20	K600	151.1	5.99
			25.4	1.00			
		PE-I <b>N</b> <b>B</b>	50.8	2.00			
			76.2	3.00			
			101.6	4.00			

Flights on 25.4 mm (1.00 in) are cut down from 50.8 mm (2.00 in).

## Accessories

### Tab / Single Link Only

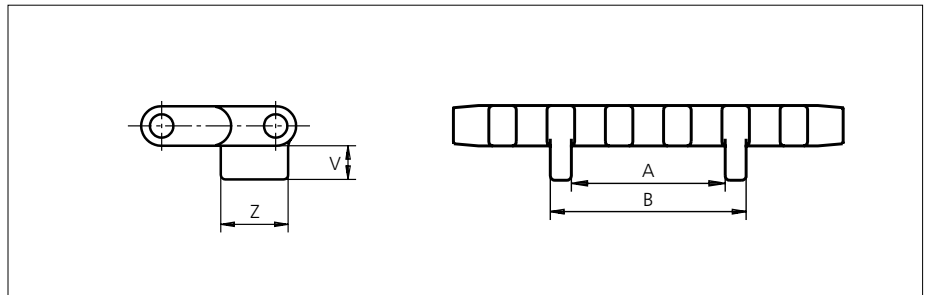
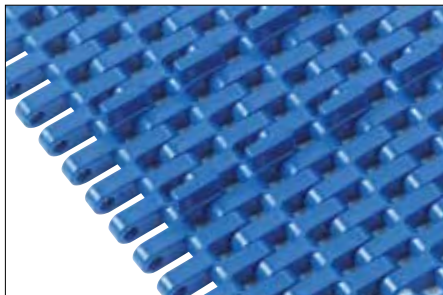

Type	Tab Material & color	V		Z		A		B		Link size	Width	
		mm	in	mm	in	mm	in	mm	in		mm	in
M2 20% Bottom Guide	PP <b>B</b>	7.50	0.29	15.0	0.59	33.5	1.19	42.7	1.68	K750	189.4	7.46

Non Standard material and color: See uni Material and Color Overview.



### Accessories

#### Rollers NON STANDARD

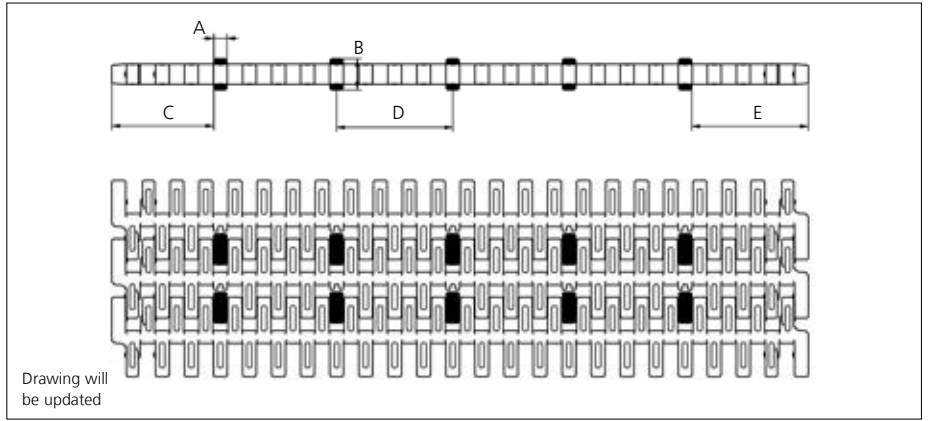
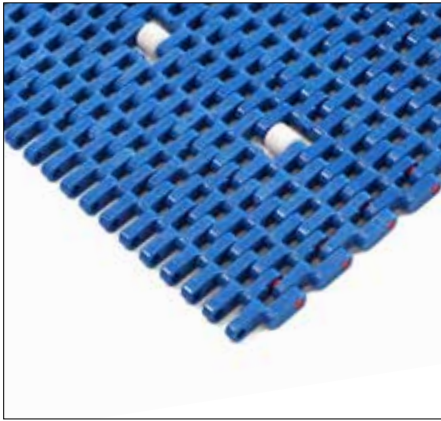

Type	Roller material & color	A		B		C		D		E	
		mm	in	mm	in	mm	in	mm	in	mm	in
Plastic	POM-D <b>W</b>	5.7	0.22	13.5	0.53	44.6	1.75	50.8	2.00	51.0	2.01

Non Standard material and color: See uni Material and Color Overview.

### Accessories

#### AmFlight

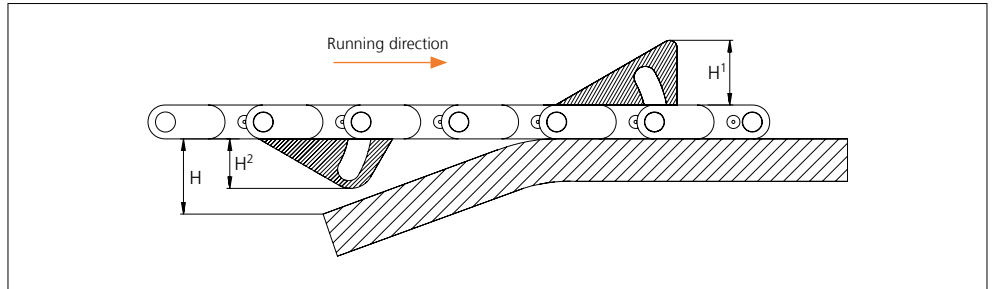
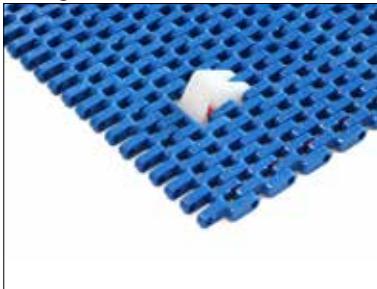

Type	Material & color	H		H <sup>1</sup>		H <sup>2</sup>	
		mm	in	mm	in	mm	in
Push	PE <b>W</b>	17.0	0.67	17.0	0.67	14.4	0.57

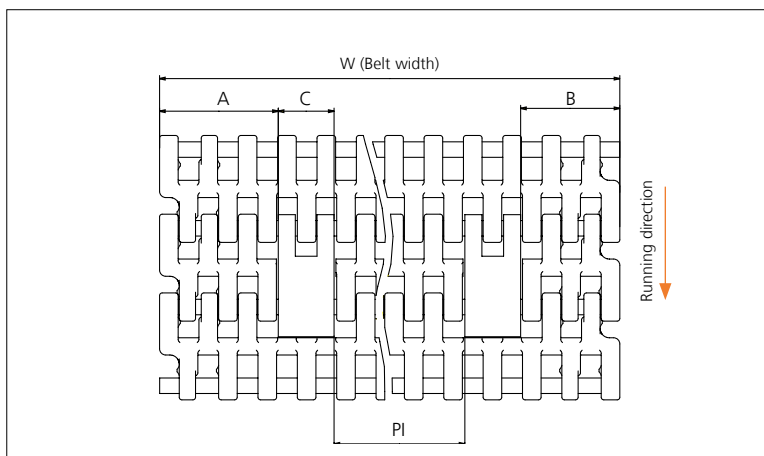

	mm	in
<b>A min</b>	38.3	1.51
<b>B min</b>	32.1	1.26
<b>C</b>	18.0	0.71
<b>PI max</b>	W - 106.4	W - 4.19
<b>PI min</b>	33.2	1.31

Increment: 12.7 mm (0.50 in).

## Sprocket

No. of teeth	Pilot Bore	Bore size							Overall diameter		Pitch diameter		Hub diameter		Dimension A		Dimension B		Single row/Two way	Molded	LG PA6
		in	1.00	1.18	1.25	1.50	1.57	2.36													
		mm	25.4	30.0	31.8	38.1	40.0	60.0	63.5												
Z10	✓	●	●	●	■	●			86.0	3.39	82.2	3.24	65.0	2.56	34.7	1.37	45.5	1.79	✓	✓	
Z12	✓	●	●	●	■	●			103.2	4.06	98.1	3.86	65.0	2.56	43.0	1.69	53.5	2.11	✓	✓	
Z18	✓		●	●	■	●			151.9	5.98	146.3	5.76	65.0	2.56	67.6	2.66	77.6	3.06	✓	✓	
Z18	✓						●	●	151.9	5.98	146.3	5.76	120.0	4.72	67.6	2.66	77.6	3.06	✓	✓	
Z19	✓		●	●	■	●			160.0	6.30	154.3	6.07	65.0	2.56	71.7	2.82	81.6	3.21	✓	✓	
Z19	✓						●	●	160.0	6.30	154.3	6.07	120.0	4.72	71.7	2.82	81.6	3.21	✓	✓	
Z20	✓		●	●	■	●			168.2	6.62	162.4	6.39	65.0	2.56	75.8	2.98	85.6	3.37	✓	✓	
Z20	✓						●	●	168.2	6.62	162.4	6.39	120.0	4.72	75.8	2.98	85.6	3.37	✓	✓	

■ Molded sprocket

● Molded sprocket

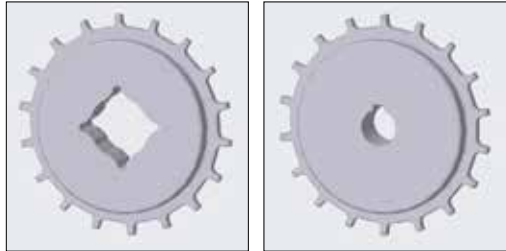

Other sprocket sizes are available upon request.

Other bore sizes on sprockets are available upon request.

Max. load per sprocket shown does not take bore size into account.

Please also ensure that sufficient size shaft is chosen for corresponding load.

Width of tooth = Single row: 6.0 mm (0.24 in)

Width of One-part sprocket = Single row: 25.0 mm (0.98 in)

## uni UltraClean Two-Part Sprocket

No. of teeth	Bore size					Overall diameter		Pitch diameter		Hub diameter		Dimension A		Dimension B		Single row/Two way	Moulded	W PA6
	in	1.50	1.57	2.36	2.50													
	mm	38.1	40.0	60.0	63.5													
Z12		■	■			103.2	4.06	98.1	3.86	80.0	3.15	43	1.69	53.5	2.11	✓	✓	
Z15		■	■			127.5	5.02	122.2	4.81	80.0	3.15	55.4	2.18	65.5	2.58	✓	✓	
Z19		1 ■	1 ■	2 ■	2 ■	160.0	6.30	154.3	6.07	<sup>1</sup> 118.0 <sup>2</sup> 126.0	<sup>1</sup> 4.65 <sup>2</sup> 4.96	71.7	2.82	81.6	3.21	✓	✓	
Z20			■			168.2	6.62	162.4	6.39	118	118.0	75.8	2.98	85.6	3.37	✓	✓	

■ Moulded uni UltraClean TwoPart Sprocket

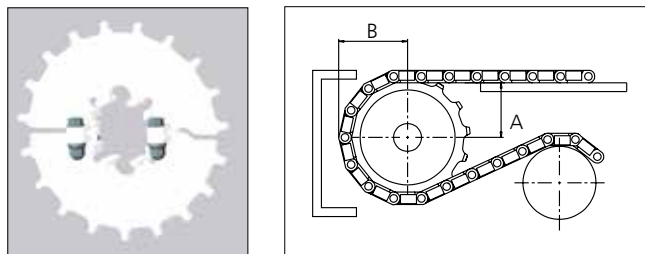

Width of UltraClean Two-part sprocket = Single row: 44.0 mm (1.73 in)

Width of UltraClean Two-part sprocket, tooth = Single row: 6.0 mm (0.24 in)

uni Retainer Rings: See uni Retainer Ring data sheet.

For correct sprocket position: See uni Assembly Instructions for uni SNB M2.

For more detailed sprocket information. contact Customer Service.

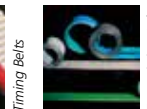
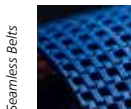

Expert advice, quality solutions and local service for all your belting needs  
[www.ammeraalbeltech.com](http://www.ammeraalbeltech.com)

**Ammeraal Beltech Modular A/S**  
Hjulmagervej 21  
DK-7100 Vejle

T +45 7572 3100  
F +45 7572 3348  
admin@unichains.com  
www.unichains.com

This information is subject to alteration due to continuous development. Ammeraal Beltech will not be held liable for the incorrect use of the above stated information. This information replaces previous information. All activities performed and services rendered by Ammeraal Beltech are subject to general terms and conditions of sale and delivery, as applied by its operating companies.



## Accessories

### Rubber Top

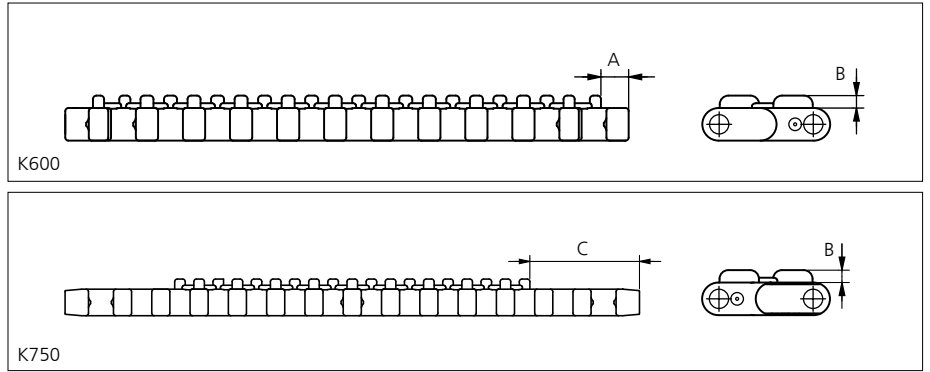
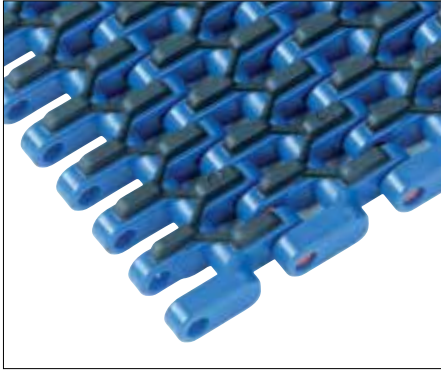

Type	Belt material & color	Rubber material & color	A		B		C		Link size	Width	
			mm	in	mm	in	mm	in		mm	in
M2 20% Flat	PP <b>B</b>	03 <b>K</b>	7.5	0.30	3.4	0.13	36.0	1.41	K300	77.0	3.00
	PP <b>W</b>	03 <b>N</b>							K600	152.4	6.00
									K750	190.5	7.50

Non Standard material and color: See uni Material and Color Overview.

## Accessories

### Flight

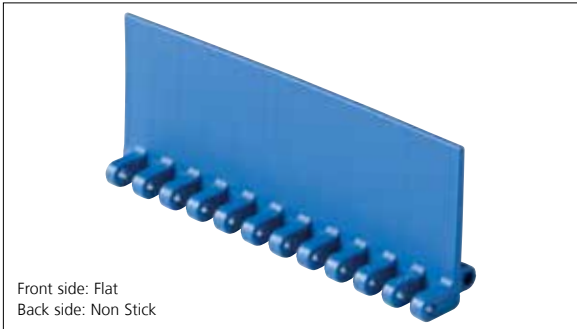

Type	Flight Material & color	H		Link size	Width		
		mm	in		mm	in	
M2 20% Flat/Non Stick	PP-I <b>W</b> <b>B</b>	PE <b>N</b> <b>B</b>	5.0	0.20	K600	151.1	5.99
			25.4	1.00			
		PE-I <b>N</b> <b>B</b>	50.8	2.00			
			76.2	3.00			
			101.6	4.00			

Flights on 25.4 mm (1.00 in) are cut down from 50.8 mm (2.00 in).

## Accessories

### Tab / Single Link Only

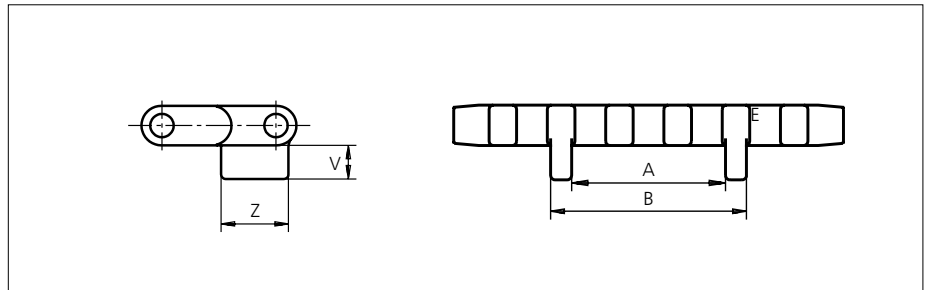

Type	Tab Material & color	V		Z		A		B		Link size	Width	
		mm	in	mm	in	mm	in	mm	in		mm	in
M2 34% Bottom Guide	POM-D <b>B</b>	7.50	0.29	15.0	0.59	33.5	1.19	42.7	1.68	K325	82.3	3.24
										K335	85.0	3.35
	PP <b>B</b>									K450	114.3	4.50
										K600	152.1	5.99
										K750	189.4	7.46

Non Standard material and color: See uni Material and Color Overview.

## Accessories

### Rollers NON STANDARD

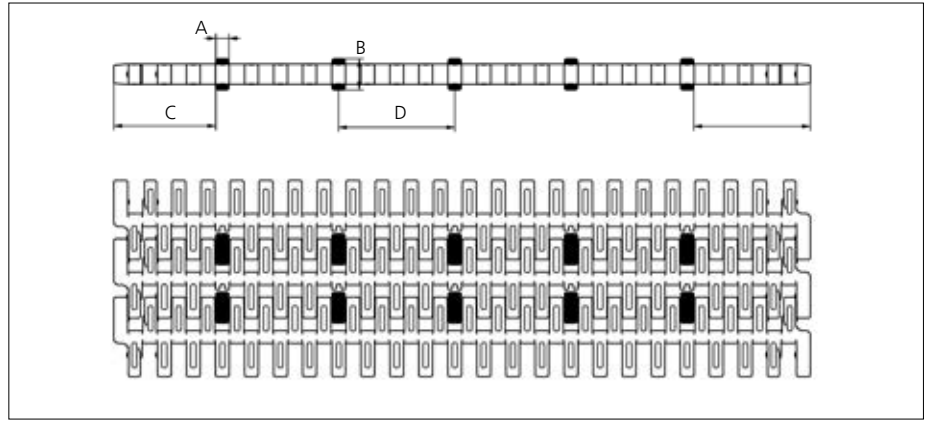
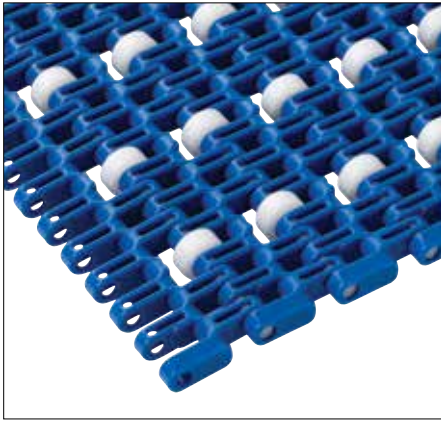

Type	Roller material & color	A		B		C		D		E	
		mm	in	mm	in	mm	in	mm	in	mm	in
Plastic	POM-D <b>W</b>	5.7	0.22	13.5	0.53	44.6	1.75	50.8	2.00	51.0	2.01

Non Standard material and color: See uni Material and Color Overview.

## Accessories

### AmFlight

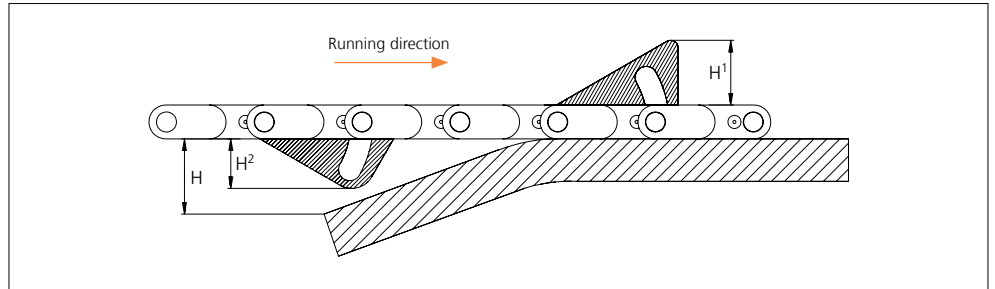
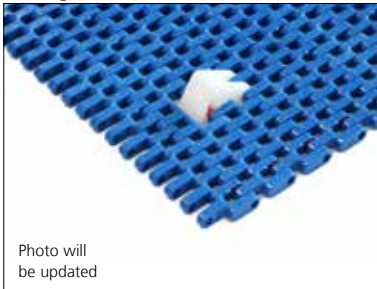

Type	Material & color	H		H <sup>1</sup>		H <sup>2</sup>	
		mm	in	mm	in	mm	in
Push	PE <b>W</b>	17.0	0.67	17.0	0.67	14.4	0.57

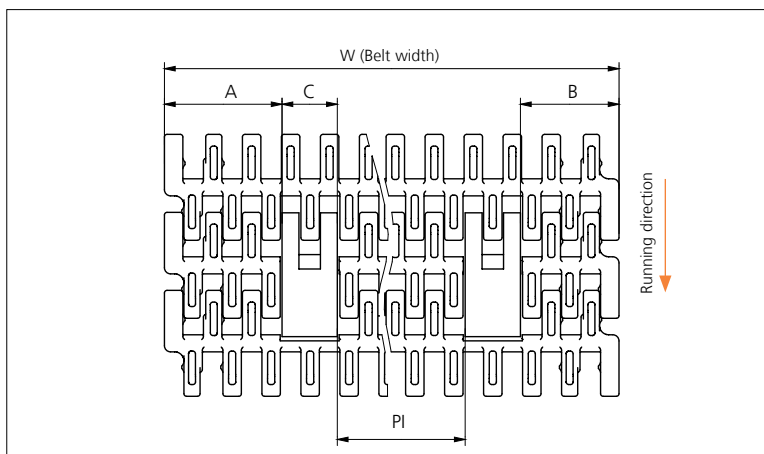

	mm	in
<b>A min</b>	38.3	1.51
<b>B min</b>	32.1	1.26
<b>C</b>	18.0	0.71
<b>PI max</b>	W - 106.4	W - 4.19
<b>PI min</b>	33.2	1.31

Increment: 12.7 mm (0.50 in).

## Sprocket

No. of teeth	Bore size								Overall diameter		Pitch diameter		Hub diameter		Dimension A		Dimension B		Single row/Two way	Molded	PA6 LG
	Pilot Bore	in		mm		mm		in													
	mm	25.4	30.0	31.8	38.1	40.0	60.0	63.5	mm	in	mm	in	mm	in	mm	in					
Z10	✓	●	●	●	■	●			86.0	3.39	82.2	3.24	65.0	2.56	34.7	1.37	45.5	1.79	✓	✓	
Z12	✓	●	●	●	■	●			103.2	4.06	98.1	3.86	65.0	2.56	43.0	1.69	53.5	2.11	✓	✓	
Z18	✓		●	●	■	■			151.9	5.98	146.3	5.76	65.0	2.56	67.6	2.66	77.6	3.06	✓	✓	
Z18	✓						●	●	151.9	5.98	146.3	5.76	120.0	4.72	67.6	2.66	77.6	3.06	✓	✓	
Z19	✓		●	●	■	■			160.0	6.30	154.3	6.07	65.0	2.56	71.7	2.82	81.6	3.21	✓	✓	
Z19	✓						●	●	160.0	6.30	154.3	6.07	120.0	4.72	71.7	2.82	81.6	3.21	✓	✓	
Z20	✓		●	●	■	■			168.2	6.62	162.4	6.39	65.0	2.56	75.8	2.98	85.6	3.37	✓	✓	
Z20	✓						●	●	168.2	6.62	162.4	6.39	120.0	4.72	75.8	2.98	85.6	3.37	✓	✓	

■ Molded sprocket



● Molded sprocket



Other sprocket sizes are available upon request.

Other bore sizes on sprockets are available upon request.

Max. load per sprocket shown does not take bore size into account.

Please also ensure that sufficient size shaft is chosen for corresponding load.

Width of tooth = Single row: 6.0 mm (0.24 in)

Width of One-part sprocket = Single row: 25.0 mm (0.98 in)

## uni UltraClean Two-Part Sprocket

No. of teeth	Bore size					Overall diameter		Pitch diameter		Hub diameter		Dimension A		Dimension B		Single row/Two way	Molded	PA6 W
	in	1.50	1.57	2.36	2.50													
	mm	38.1	40.0	60.0	63.5	mm	in	mm	in	mm	in	mm	in					
Z12		■	■			103.2	4.06	98.1	3.86	80.0	3.15	43	1.69	53.5	2.11	✓	✓	
Z15		■	■			127.5	5.02	122.2	4.81	80.0	3.15	55.4	2.18	65.5	2.58	✓	✓	
Z19		<sup>1</sup> ■	<sup>1</sup> ■	<sup>2</sup> ■	<sup>2</sup> ■	160.0	6.30	154.3	6.07	<sup>1</sup> 118.0 <sup>2</sup> 126.0	<sup>1</sup> 4.65 <sup>2</sup> 4.96	71.7	2.82	81.6	3.21	✓	✓	
Z20			■			168.2	6.62	162.4	6.39	118	118.0	75.8	2.98	85.6	3.37	✓	✓	

■ Moulded uni UltraClean TwoPart Sprocket

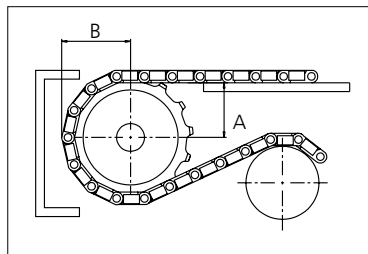

Width of UltraClean Two-part sprocket = Single row: 44.0 mm (1.73 in)

Width of UltraClean Two-part sprocket, tooth = Single row: 6.0 mm (0.24 in)

uni Retainer Rings: See uni Retainer Ring data sheet.

For correct sprocket position: See uni Assembly Instructions for uni SNB M2.

For more detailed sprocket information. contact Customer Service.

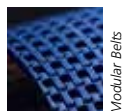

Expert advice, quality solutions and local service for all your belting needs [www.ammeraalbeltech.com](http://www.ammeraalbeltech.com)

**Ammeraal Beltech Modular A/S**  
Hjulmagervej 21  
DK-7100 Vejle

T +45 7572 3100  
F +45 7572 3348  
admin@unichains.com  
www.unichains.com

This information is subject to alteration due to continuous development. Ammeraal Beltech will not be held liable for the incorrect use of the above stated information. This information replaces previous information. All activities performed and services rendered by Ammeraal Beltech are subject to general terms and conditions of sale and delivery, as applied by its operating companies.



# Plastic Modular Belt

Series **uni SNB** Type **M2 34% Rib**

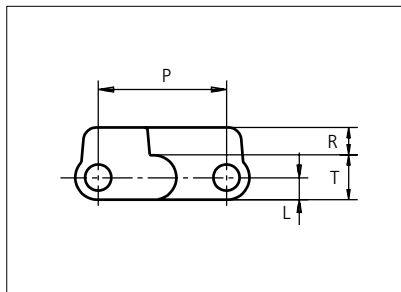
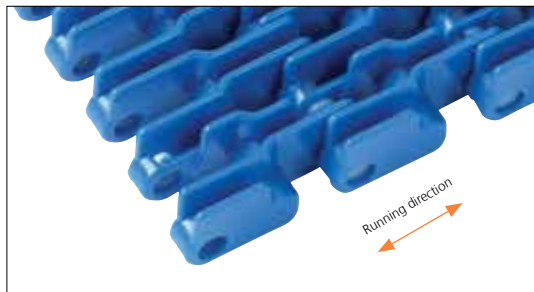

Straight running belt  
 Nominal pitch: 25.4 mm (1.00 in)  
 Surface type: Rib Top  
 Surface opening: 34%  
 Backflex radius: 30.0 mm (1.20 in)  
 Pin diameter: 5.0 mm (0.20 in)

Belt material & color	POM-SLF <b>B</b>	PP <b>B</b>	mm	in		mm	in	
			<b>P (Nominal)</b>	25.4	1.00	<b>R</b>	5.5	0.22
Pin material & color	PP <b>B</b>		<b>L</b>	4.4	0.17	<b>T</b>	8.8	0.35

Non standard material and color: See uni Material and Color Overview.

Alternative pin and lock materials: Pin: PA6.6 **B** SS304

Endlock: PP-I **B**

Lockpin: PP **W** PBT **LG** PA6.6 **D** **N** PE **N**

Belt width		Permissible tensile force (Belt/pin material)				Belt weight (Belt/pin material)				*Min. No. drive sprocket per shaft	Number of wear strips (Min. No.)	
		POM-SLF/PP		PP/PP		POM-SLF/PP		PP/PP			**Carry (pcs)	**Return (pcs)
mm	in	N	lbf	N	lbf	Kg/m	lb/ft	Kg/m	lb/ft			
77	3.0	1810	407	1155	260	0.5	0.33	0.3	0.22	2	2	2
153	6.0	3596	808	2295	516	1.0	0.65	0.7	0.44	2	2	2
229	9.0	5382	1210	3435	772	1.4	0.97	1.0	0.66	2	2	2
305	12.0	7168	1611	4575	1028	1.9	1.29	1.3	0.88	3	3	2
381	15.0	8954	2013	5715	1285	2.4	1.61	1.6	1.10	3	3	2
457	18.0	10740	2414	6855	1541	2.9	1.93	2.0	1.32	4	4	2
533	21.0	12526	2816	7995	1797	3.4	2.26	2.3	1.54	4	4	2
609	24.0	14312	3217	9135	2054	3.8	2.58	2.6	1.76	5	5	3
685	27.0	16098	3619	10275	2310	4.3	2.90	2.9	1.98	5	5	3
761	30.0	17884	4020	11415	2566	4.8	3.22	3.3	2.20	6	6	3
837	33.0	19670	4422	12555	2822	5.3	3.54	3.6	2.42	6	6	3
913	35.9	21456	4823	13695	3079	5.8	3.87	3.9	2.64	7	7	4
989	38.9	23242	5225	14835	3335	6.2	4.19	4.3	2.86	7	7	4

Additional standard belt widths are available in steps of 76.1 mm (3.00 in). Additional non-standard belt widths are available in steps of 12.7 mm (0.50 in).

1979	77.9	46507	10455	29685	6673	12.5	8.38	8.5	5.72	14	14	7
------	------	-------	-------	-------	------	------	------	-----	------	----	----	---

Additional standard belt widths are available in steps of 76.1 mm (3.00 in). Additional non-standard belt widths are available in steps of 12.7 mm (0.50 in).

2969	116.9	69772	15685	44535	10011	18.7	12.57	12.8	8.58	20	20	10
------	-------	-------	-------	-------	-------	------	-------	------	------	----	----	----

General belt tolerance is +0/-0.4% at 23°C/73°F and 50% RH. For exact belt width contact Customer Service. Non standard belt width on request.

\*Max. Load per Drive Sprocket. Belt material: POM-D 1400 N (315 lbf), PP 1100 N (247 lbf).

\*\*Max. Spacing between wear strips, Carry: 152.0 mm (6.00 in); Return: 304.0 mm (12.00 in).

= Single Link



STANDARD

STRAIGHT RUNNING

PITCH 25.4 MM/1.00 IN

## Accessories

### Finger Plates

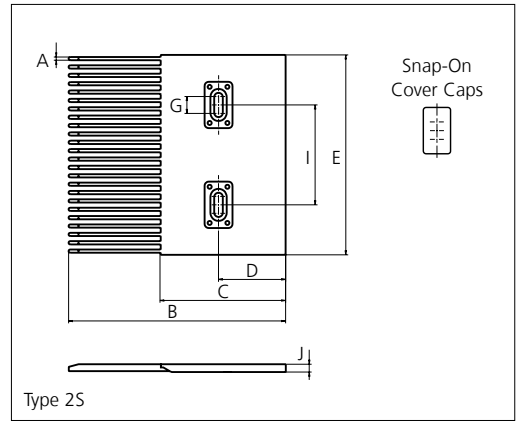
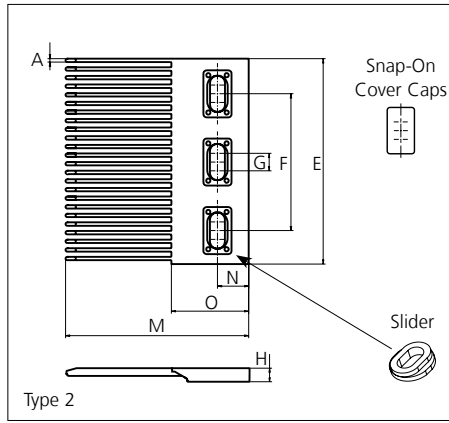

Type	Material & color	A		B		C		D		E		F			
		mm	in	mm	in	mm	in	mm	in	mm	in	mm	in		
Single Sided	POM-EC <b>K</b>	2.5	0.10	165.0	6.50	95.0	3.74	51.0	2.01	152.1	5.99	100.0	3.94		
Single Sided															
		G		H		I		J		M		N		O	
		mm	in	mm	in	mm	in	mm	in	mm	in	mm	in	mm	in
		12.0	0.47	10.3	0.41	76.0	3.00	6.0	0.24	135.0	5.31	23.0	0.91	57.0	2.24

All uni-chains belt systems are available in a raised rib version that can be supplied with matching finger plates also called combs. The finger plates are supplied with cover caps which can be attached when the finger plate has been installed. The cover caps can be removed by using a screwdriver that can be inserted between the cover and finger plate. In order to adjust to belt width variations caused by temperature fluctuations, a slider facilitates the sideways movement of the finger plates.

Non Standard material and color: See uni Material and Color Overview.



### Sprocket

No. of teeth	Bore size									Overall diameter		Pitch diameter		Hub diameter		Dimension A		Dimension B		Single row/Two way	Molded	PAG LG
	Pilot Bore	1.00		1.18		1.25		1.50														
	in	mm	25.4	30.0	31.8	38.1	40.0	60.0	63.5	mm	in	mm	in	mm	in	mm	in					
Z10	✓		●	●	●	■	●			86.0	3.39	82.2	3.24	65.0	2.56	34.7	1.37	45.5	1.79	✓	✓	
Z12	✓		●	●	●	■	■			103.2	4.06	98.1	3.86	65.0	2.56	43.0	1.69	53.5	2.11	✓	✓	
Z18	✓			●	●	■	■			151.9	5.98	146.3	5.76	65.0	2.56	67.6	2.66	77.6	3.06	✓	✓	
Z18	✓							●	●	151.9	5.98	146.3	5.76	120.0	4.72	67.6	2.66	77.6	3.06	✓	✓	
Z19	✓			●	●	■	■			160.0	6.30	154.3	6.07	65.0	2.56	71.7	2.82	81.6	3.21	✓	✓	
Z19	✓							●	●	160.0	6.30	154.3	6.07	120.0	4.72	71.7	2.82	81.6	3.21	✓	✓	
Z20	✓			●	●	■	■			168.2	6.62	162.4	6.39	65.0	2.56	75.8	2.98	85.6	3.37	✓	✓	
Z20	✓							●	●	168.2	6.62	162.4	6.39	120.0	4.72	75.8	2.98	85.6	3.37	✓	✓	

■ Molded sprocket

● Molded sprocket



Other sprocket sizes are available upon request.  
 Other bore sizes on sprockets are available upon request.  
 Max. load per sprocket shown does not take bore size into account.  
 Please also ensure that sufficient size shaft is chosen for corresponding load.  
 Width of tooth = Single row: 6.0 mm (0.24 in)  
 Width of One-part sprocket = Single row: 25.0 mm (0.98 in)

### uni UltraClean Two-Part Sprocket

No. of teeth	Bore size					Overall diameter		Pitch diameter		Hub diameter		Dimension A		Dimension B		Single row/Two way	Molded	PAG W
	in	1.50	1.57	2.36	2.50													
	mm	38.1	40.0	60.0	63.5	mm	in	mm	in	mm	in	mm	in					
Z12		■	■			103.2	4.06	98.1	3.86	80.0	3.15	43	1.69	53.5	2.11	✓	✓	
Z15		■	■			127.5	5.02	122.2	4.81	80.0	3.15	55.4	2.18	65.5	2.58	✓	✓	
Z19		1 ■	1 ■	2 ■	2 ■	160.0	6.30	154.3	6.07	<sup>1</sup> 118.0 <sup>2</sup> 126.0	<sup>1</sup> 4.65 <sup>2</sup> 4.96	71.7	2.82	81.6	3.21	✓	✓	
Z20			■			168.2	6.62	162.4	6.39	118	118.0	75.8	2.98	85.6	3.37	✓	✓	

■ Moulded uni UltraClean TwoPart Sprocket

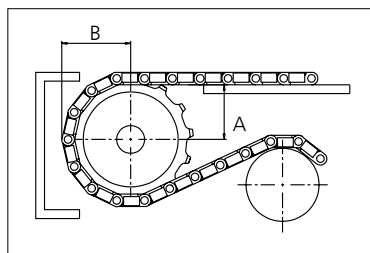

Width of UltraClean Two-part sprocket = Single row: 44.0 mm (1.73 in)  
 Width of UltraClean Two-part sprocket, tooth = Single row: 6.0 mm (0.24 in)

uni Retainer Rings: See uni Retainer Ring data sheet.  
 For correct sprocket position: See uni Assembly Instructions for uni SNB M2.  
 For more detailed sprocket information, contact Customer Service.



Conveyor Belts



Seamless Belts

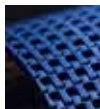

Modular Belts



Timing Belts



Transmission Belts



Fabrication & service

Expert advice, quality solutions and local service for all your belting needs  
[www.ammeraalbeltech.com](http://www.ammeraalbeltech.com)

**Ammeraal Beltech Modular A/S**  
Hjulmagervej 21  
DK-7100 Vejle

T +45 7572 3100  
F +45 7572 3348  
admin@unichains.com  
www.unichains.com

This information is subject to alteration due to continuous development. Ammeraal Beltech will not be held liable for the incorrect use of the above stated information. This information replaces previous information. All activities performed and services rendered by Ammeraal Beltech are subject to general terms and conditions of sale and delivery, as applied by its operating companies.



# Plastic Modular Belt

Series **uni SNB** Type **M2 50%**

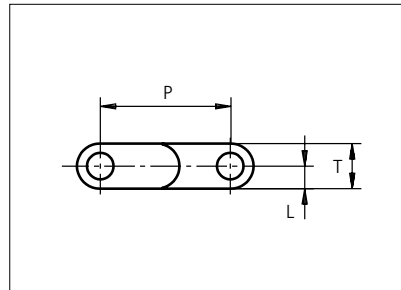
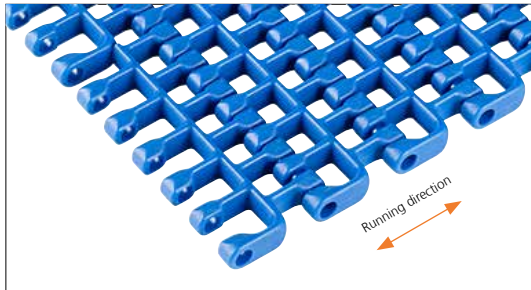

Straight running belt  
 Nominal pitch: 25.4 mm (1.00 in)  
 Surface type: Flat  
 Surface opening: 50%  
 Backflex radius: 30.0 mm (1.20 in)  
 Pin diameter: 5.0 mm (0.20 in)

Belt material & color	PA6.6 <b>B</b>	PP <b>B</b>	PP <b>W</b>	mm	in		mm	in	
				P (Nominal)	25.4	1.00	L	4.4	0.17
Pin material & color	PP <b>B</b>			PP <b>W</b>					
				T	8.8	0.35	-	-	-

Non standard material and color: See uni Material and Color Overview.

Alternative pin and lock materials: Lockpin: PBT **LG** PA6.6 **D** **N** PP **B** **W** PE **N**

Belt width		Permissible tensile force (Belt/pin material)				Belt weight (Belt/pin material)				*Min. No. drive sprocket per shaft	Number of wear strips (Min. No.)	
		PP/PP		PA6.6/PP		PP/PP		PA6.6/PP			**Carry (pcs)	**Return (pcs)
mm	in	N	lbf	N	lbf	kg/m	lb/ft	kg/m	lb/ft			
153	6.0	1836	413	3060	688	0.5	0.31	0.6	0.38	2	2	2
229	9.0	2748	618	4580	1030	0.7	0.47	0.8	0.56	2	2	2
305	12.0	3660	823	6100	1371	0.9	0.62	1.1	0.75	3	3	2
381	15.0	4572	1028	7620	1713	1.2	0.78	1.4	0.94	3	3	2
457	18.0	5484	1233	9140	2055	1.4	0.93	1.7	1.13	4	4	2
533	21.0	6396	1438	10660	2396	1.6	1.09	2.0	1.31	4	4	2
609	24.0	7308	1643	12180	2738	1.8	1.24	2.2	1.50	5	5	3
685	27.0	8220	1848	13700	3080	2.1	1.39	2.5	1.69	5	5	3
761	30.0	9132	2053	15220	3421	2.3	1.55	2.8	1.88	6	6	3
837	33.0	10044	2258	16740	3763	2.5	1.70	3.1	2.06	6	6	3
913	35.9	10956	2463	18260	4105	2.8	1.86	3.4	2.25	7	7	4
989	38.9	11868	2668	19780	4447	3.0	2.01	3.6	2.44	7	7	4
1065	41.9	12780	2873	21300	4788	3.2	2.17	3.9	2.63	8	8	4

Additional standard belt widths are available in steps of 76.1 mm (3.00 in). Additional non-standard belt widths are available in steps of 12.7 mm (0.50 in).

1977	77.8	23724	5333	39540	8889	6.0	4.03	7.3	4.88	14	14	7
------	------	-------	------	-------	------	-----	------	-----	------	----	----	---

Additional standard belt widths are available in steps of 76.1 mm (3.00 in). Additional non-standard belt widths are available in steps of 12.7 mm (0.50 in).

2965	116.7	35580	7998	59300	13331	9.0	6.04	10.9	7.31	20	20	10
------	-------	-------	------	-------	-------	-----	------	------	------	----	----	----

General belt tolerance is +0/-0.4% at 23°C/73°F and 50% RH. For exact belt width contact Customer Service. Non standard belt width on request.

Belt widths in PA66 is 0,2 % wider than the belt widths in the table above.

\*Max. Load per Drive Sprocket. Belt material: PP 1100 N (247 lbf); PA66 1400 N (315 lbf).

\*\*Max. Spacing between wear strips, Carry: 152.0 mm (6.00 in); Return: 304.0 mm (12.00 in).

= Single Link



STANDARD

STRAIGHT RUNNING

PITCH 25.4 MM/1.00 IN

## Accessories

### Rollers NON STANDARD

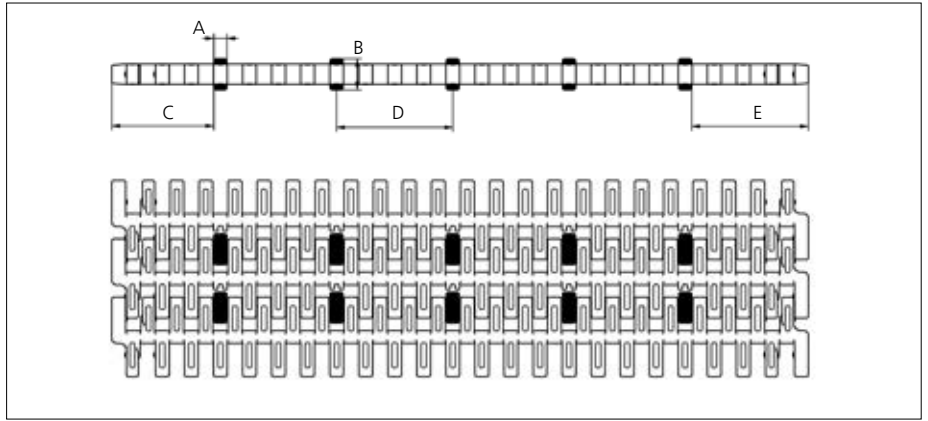
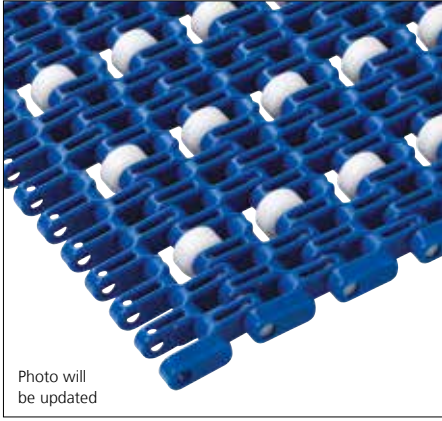

Type	Roller material & color	A		B		C		D		E	
		mm	in	mm	in	mm	in	mm	in	mm	in
Plastic	POM-D <b>W</b>	5.7	0.22	13.5	0.53	44.6	1.75	50.8	2.00	51.0	2.01

Non Standard material and color: See uni Material and Color Overview.

## Accessories

### AmFlight

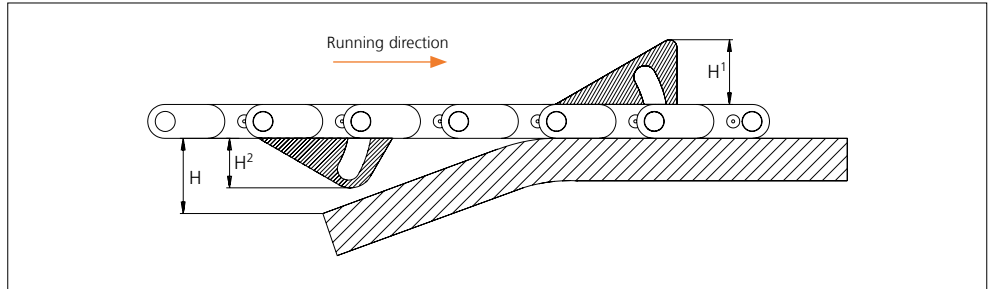
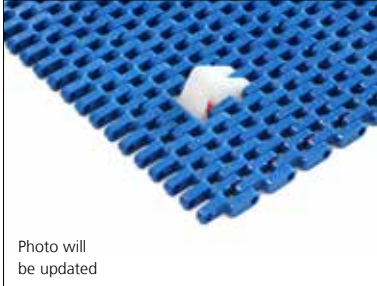

Type	Material & color	H		H <sup>1</sup>		H <sup>2</sup>	
		mm	in	mm	in	mm	in
Push	PE <b>W</b>	17.0	0.67	17.0	0.67	14.4	0.57

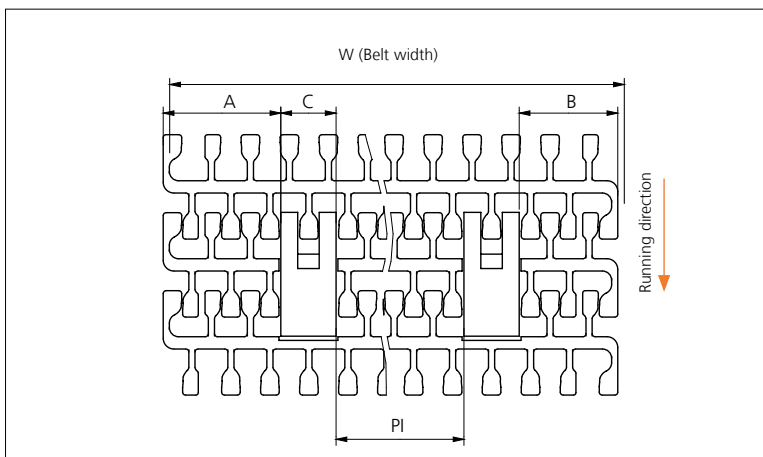

	mm	in
<b>A min</b>	38.3	1.51
<b>B min</b>	32.1	1.26
<b>C</b>	18.0	0.71
<b>PI max</b>	W - 106.4	W - 4.19
<b>PI min</b>	33.2	1.31

Increment: 12.7 mm (0.50 in).

## Sprocket

No. of teeth	Bore size									Overall diameter		Pitch diameter		Hub diameter		Dimension A		Dimension B		Single row/Two way	Molded	PAG	LG
	Pilot Bore	1.00		1.25		1.50		2.36															
	in	mm	25.4	30.0	31.8	38.1	40.0	60.0	63.5	mm	in	mm	in	mm	in	mm	in						
Z10	✓		●	●	●	■	●			86.0	3.39	82.2	3.24	65.0	2.56	34.7	1.37	45.5	1.79	✓	✓		
Z12	✓		●	●	●	■	■			103.2	4.06	98.1	3.86	65.0	2.56	43.0	1.69	53.5	2.11	✓	✓		
Z18	✓			●	●	■	■			151.9	5.98	146.3	5.76	65.0	2.56	67.6	2.66	77.6	3.06	✓	✓		
Z18	✓							●	●	151.9	5.98	146.3	5.76	120.0	4.72	67.6	2.66	77.6	3.06	✓	✓		
Z19	✓			●	●	■	■			160.0	6.30	154.3	6.07	65.0	2.56	71.7	2.82	81.6	3.21	✓	✓		
Z19	✓							●	●	160.0	6.30	154.3	6.07	120.0	4.72	71.7	2.82	81.6	3.21	✓	✓		
Z20	✓			●	●	■	■			168.2	6.62	162.4	6.39	65.0	2.56	75.8	2.98	85.6	3.37	✓	✓		
Z20	✓							●	●	168.2	6.62	162.4	6.39	120.0	4.72	75.8	2.98	85.6	3.37	✓	✓		

■ Molded sprocket

● Molded sprocket

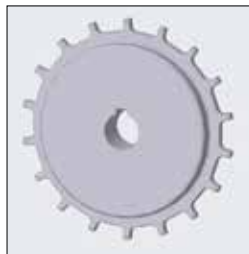

Other sprocket sizes are available upon request.

Other bore sizes on sprockets are available upon request.

Max. load per sprocket shown does not take bore size into account.

Please also ensure that sufficient size shaft is chosen for corresponding load.

Width of tooth = Single row: 6.0 mm (0.24 in)

Width of One-part sprocket = Single row: 25.0 mm (0.98 in)

## uni UltraClean Two-Part Sprocket

No. of teeth	Bore size					Overall diameter		Pitch diameter		Hub diameter		Dimension A		Dimension B		Single row/Two way	Molded	PAG	W
	in	1.50	1.57	2.36	2.50														
	mm	38.1	40.0	60.0	63.5	mm	in	mm	in	mm	in	mm	in						
Z12		■	■			103.2	4.06	98.1	3.86	80.0	3.15	43	1.69	53.5	2.11	✓	✓		
Z15		■	■			127.5	5.02	122.2	4.81	80.0	3.15	55.4	2.18	65.5	2.58	✓	✓		
Z19		1 ■	1 ■	2 ■	2 ■	160.0	6.30	154.3	6.07	<sup>1</sup> 118.0 <sup>2</sup> 126.0	<sup>1</sup> 4.65 <sup>2</sup> 4.96	71.7	2.82	81.6	3.21	✓	✓		
Z20			■			168.2	6.62	162.4	6.39	118	118.0	75.8	2.98	85.6	3.37	✓	✓		

■ Moulded uni UltraClean TwoPart Sprocket

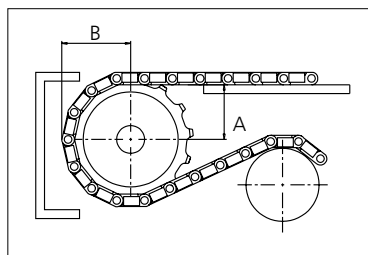

Width of UltraClean Two-part sprocket = Single row: 44.0 mm (1.73 in)

Width of UltraClean Two-part sprocket, tooth = Single row: 6.0 mm (0.24 in)

uni Retainer Rings: See uni Retainer Ring data sheet.

For correct sprocket position: See uni Assembly Instructions for uni SNB M2.

For more detailed sprocket information, contact Customer Service.



Conveyor Belts



Seamless Belts



Modular Belts



Timing Belts

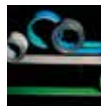

Transmission Belts



Fabrication & service

Expert advice, quality solutions  
and local service  
for all your belting needs  
[www.ammeraalbeltech.com](http://www.ammeraalbeltech.com)

**Ammeraal Beltech Modular A/S**  
Hjulgagervej 21  
DK-7100 Vejle

T +45 7572 3100  
F +45 7572 3348  
[admin@unichains.com](mailto:admin@unichains.com)  
[www.unichains.com](http://www.unichains.com)

This information is subject to alteration due to continuous development. Ammeraal Beltech will not be held liable for the incorrect use of the above stated information. This information replaces previous information. All activities performed and services rendered by Ammeraal Beltech are subject to general terms and conditions of sale and delivery, as applied by its operating companies.



# Plastic Modular Belt

Series **uni SSB** Type **C**

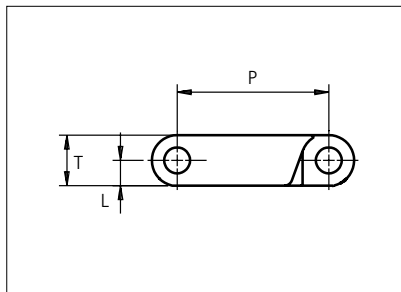
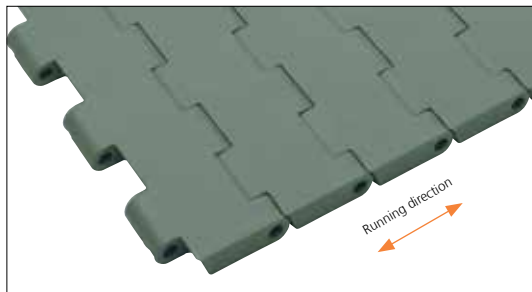

Straight running belt  
 Nominal pitch: 38.1 mm (1.50 in)  
 Surface type: Flat  
 Surface opening: Closed  
 Backflex radius: 45.0 mm (1.8 in)  
 Pin diameter: 6.4 mm (0.25 in)

<b>Belt material &amp; color</b>	POM-LF <b>BR</b>	PP <b>G</b>	mm	in	mm	in		
<b>Pin and lock material &amp; color</b>	PBT-GR <b>N</b>	PP <b>B</b>	<b>P (Nominal)</b>	38.1	1.50	<b>T</b>	12.7w	0.50
			<b>L</b>	6.4	0.25	-	-	-

Non standard material and color: See uni Material and Color Overview.

Alternative pin and lock materials: Pin: PP **W** PA66 **N** SS304

Belt width		Permissible tensile force (Belt/pin material)				Belt weight (Belt/pin material)				*Min. No. drive sprocket per shaft	Number of wear strips (Min. No.)	
		POM-LF/PBT-GR		PP/PBT-GR		POM-LF/PBT-GR		PP/PBT-GR			**Carry (pcs)	**Return (pcs)
mm	in	N	lbf	N	lbf	kg/m	lb/ft	kg/m	lb/ft			
83	3.3	2988	672	1079	243	0.9	0.63	0.6	0.41	2	2	2
115	4.5	4140	931	1495	336	1.3	0.87	0.9	0.57	2	2	2
153	6.0	5513	1239	1991	448	1.7	1.16	1.1	0.76	2	2	2
191	7.5	6876	1546	2483	558	2.2	1.45	1.4	0.95	2	2	2
229	9.0	8244	1853	2977	669	2.6	1.74	1.7	1.14	2	2	2
305	12.0	10980	2468	3965	891	3.4	2.32	2.3	1.52	3	3	2
381	15.0	13716	3083	4953	1113	4.3	2.89	2.8	1.89	3	3	2
457	18.0	16452	3698	5941	1336	5.2	3.47	3.4	2.27	4	4	2
533	21.0	19188	4313	6929	1558	6.0	4.05	3.9	2.65	4	4	2
609	24.0	21924	4929	7917	1780	6.9	4.62	4.5	3.03	5	5	3
685	27.0	24660	5544	8905	2002	7.7	5.20	5.1	3.41	5	5	3
761	30.0	27396	6159	9893	2224	8.6	5.78	5.6	3.78	6	6	3

Additional standard belt widths are available in steps of 76.1 mm (3.00 in). Additional non-standard belt widths are available in steps of 25.4 mm (1.00 in).

1979	77.9	71244	16016	25727	5783	22.4	15.03	14.6	9.84	14	14	7
------	------	-------	-------	-------	------	------	-------	------	------	----	----	---

Additional standard belt widths are available in steps of 76.1 mm (3.00 in). Additional non-standard belt widths are available in steps of 25.4 mm (1.00 in).

2968	116.9	106848	24019	38584	8674	33.5	22.54	22.0	14.76	20	20	10
------	-------	--------	-------	-------	------	------	-------	------	-------	----	----	----

For belt width above 2968 mm, please contact our customer service to review packaging and handling.

General belt tolerance is +0/-0.4% at 23°C/73°F and 50% RH. For exact belt width contact Customer Service. Non standard belt width on request.

\*Max. Load per Drive Sprocket. Belt material: POM-LF 2000 N (450 lbf), PP 1200 N (270 lbf).

\*\*Max. Spacing between wear strips, Carry: 152.0 mm (6.00 in); Return: 304.0 mm (12.00 in).

= Single Link



STANDARD

STRAIGHT RUNNING

PITCH 38.1 MM/1.50 IN

### Accessories

#### NON STANDARD – Rubber Top

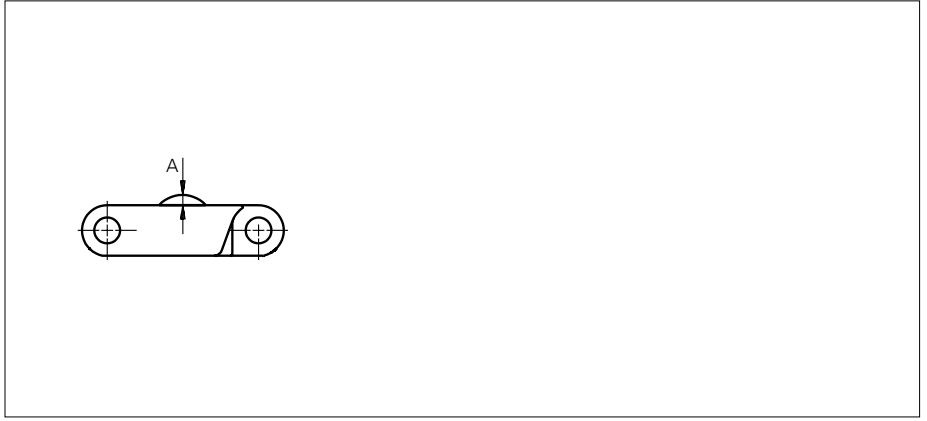

Type	Recommended belt material & color	Recommended rubber material & color	A		Link size	Width	
			mm	in		mm	in
Curved	POM-LF <b>BR</b>	05 <b>I</b>	2.5	0.10	K600	152.2	5.99

Non Standard material and color: See uni Material and Color Overview.

### Accessories

#### Flight

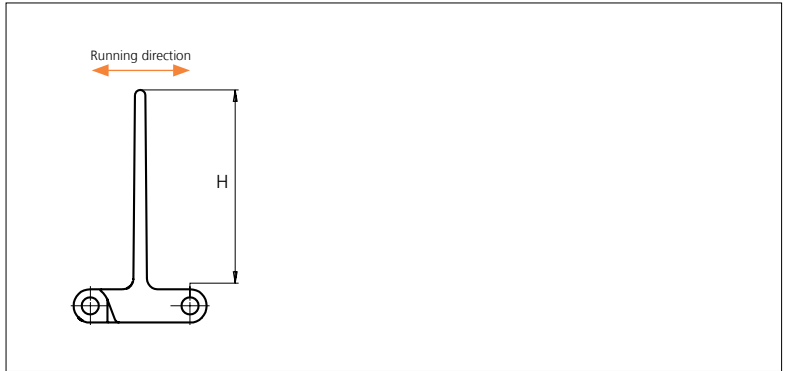

Type	Flight Material & color	H		Link size	Width	
		mm	in		mm	in
Flat	PP-I <b>G</b>	76.1	3.00	K600	152.0	5.99

Non Standard material and color: See uni Material and Color Overview.

Minimum bricklaid indent is for uni SSB Product Support 50.8 mm (2.00 in).

Increment: 25.4 mm (1.00 in).



## Accessories

### NON STANDARD – Tab / Single Link Only

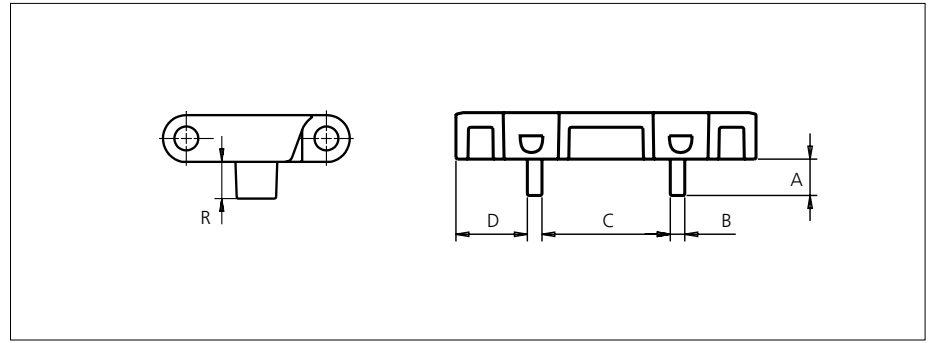
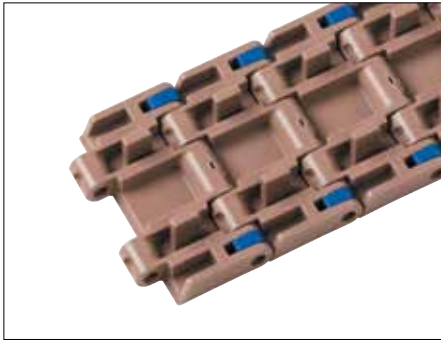

Type	Recommended belt material & color	R		D		C		B		A		Link size	Width	
		mm	in	mm	in	mm	in	mm	in	mm	in		mm	in
Bottom Guide	POM-LF <b>BR</b>	10.0	0.39	19.6	0.77	35.2	1.39	4.0	0.16	10.0	0.39	K325	82.6	3.25

Non Standard material and color: See uni Material and Color Overview.

### Overview Sprocket Placement

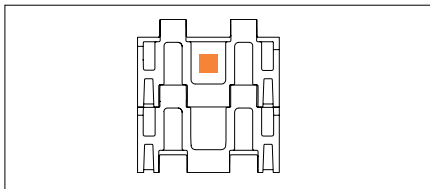

uni SSB K325

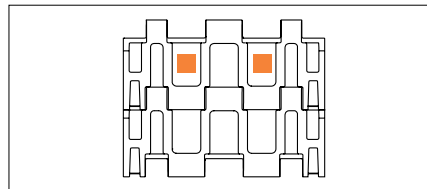

uni SSB K450

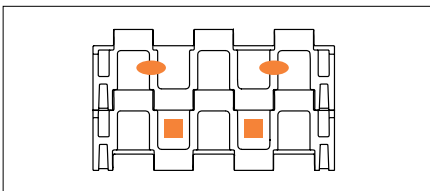

uni SSB K600

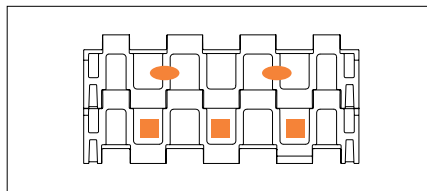

uni SSB K750

- = Single Row sprocket
- = Double Row sprocket

## Sprocket

No. of teeth	Bore size													Overall diameter		Pitch diameter		Hub diameter		Dimension A		Dimension B		Single row/Two way	Double row/Two way	Molded PA6 LG	Machined PA6 N
	Pilot Bore	in	0.75	0.78	0.98	1.00	1.18	1.25	1.50	1.57	2.36	2.50	3.54														
	mm	19.1	20.0	25.0	25.4	30.0	31.8	38.1	40.0	60.0	63.5	90.0	mm	in	mm	in	mm	in	mm	in							
Z19	x				●	●	●	■	●				117.0	4.61	117.3	4.62	75.0	2.95	49.1	1.93	65.0	2.56	x	x	x		
Z21	x				●	●	●	■	●				130.0	5.12	129.3	5.09	75.0	2.95	55.4	2.18	71.0	2.80	x	x	x		
Z23	x				●	●	●	■	●				142.0	5.59	141.2	5.56	75.0	2.95	61.6	2.43	77.0	3.03	x	x	x		
Z25	x					●	●	■	●				155.0	6.10	153.2	6.03	75.0	2.95	67.8	2.67	83.0	3.27	x	x	x		
Z27	x							●	●	■	●		167.0	6.57	165.2	6.50	75.0	2.95	74.0	2.91	89.0	3.50		x		x	
Z29	x							●	●	■	●		179.0	7.05	177.2	6.98	75.0	2.95	80.2	3.16	95.0	3.74		x		x	
Z31	x							●	●	■	●		192.0	7.56	189.3	7.45	75.0	2.95	86.4	3.40	101.0	3.98		x		x	

■ Molded sprocket

● Molded sprocket

● Molded sprocket

■ Machined sprocket

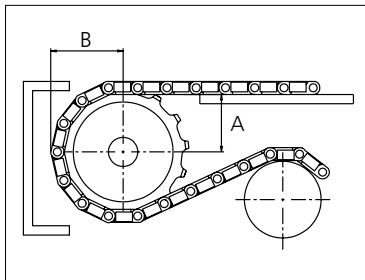

● Machined sprocket

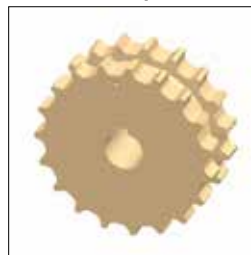

Non standard material and color: See uni Material and Color Overview.

Other sprocket sizes are available upon request.

Two-part sprocket are available upon request.

Round bores are always delivered with keyway.

Other bore sizes are available upon request.

uni Retainer Rings: See uni Retainer Ring data sheet.

Width of tooth: 15.0 mm/0.59 in

Width of sprocket: Single row = 42.3 mm (1.67 in)

Double row = 42.3 mm (1.67 in)

Max. load per sprocket shown does not take bore size into account.

Please also ensure that sufficient size shaft is chosen for corresponding load.

For correct sprocket position: See uni Assembly Instructions for uni SSB.

For more detailed sprocket information, contact Customer Service.

uni SSB C/170522



Conveyor Belts



Seamless Belts



Modular Belts



Timing Belts



Transmission Belts



Fabrication & service

Expert advice, quality solutions and local service for all your belting needs [www.ammeraalbeltech.com](http://www.ammeraalbeltech.com)

**Ammeraal Beltech Modular A/S**  
Hjulmagervej 21  
DK-7100 Vejle

T +45 7572 3100  
F +45 7572 3348  
admin@unichains.com  
www.unichains.com

This information is subject to alteration due to continuous development. Ammeraal Beltech will not be held liable for the incorrect use of the above stated information. This information replaces previous information. All activities performed and services rendered by Ammeraal Beltech are subject to general terms and conditions of sale and delivery, as applied by its operating companies.



# Plastic Modular Belt

Series **uni SSB** Type **22%**

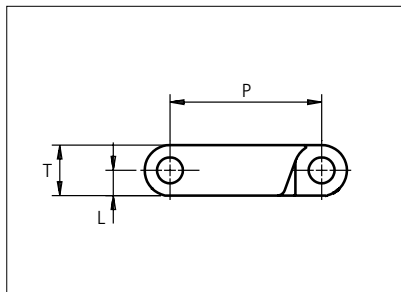

Straight running belt  
 Nominal pitch: 38.1 mm (1.50 in)  
 Surface type: Flat  
 Surface opening: 22%  
 Backflex radius: 45.0 mm (1.8 in)  
 Pin diameter: 6.4 mm (0.25 in)

Recommended belt material & color	POM-LF <b>BR</b>	PP <b>G</b>	mm	in	mm	in		
	Recommended pin and lock material & color		P (Nominal)	38.1	1.50	T	12.7	0.50
	PBT-GR <b>N</b>	PP <b>B</b>	L	6.4	0.25	-	-	-

Non standard material and color: See uni Material and Color Overview.

Alternative pin and lock materials: Pin: PP **W** PA66 **N** SS304

Belt width		Permissible tensile force (Belt/pin material)				Belt weight (Belt/pin material)				*Min. No. drive sprocket per shaft	Number of wear strips (Min. No.)	
		POM-LF/PBT-GR		PP/PBT-GR		POM-LF/PBT-GR		PP/PBT-GR			**Carry (pcs)	**Return (pcs)
mm	in	N	lbf	N	lbf	kg/m	lb/ft	kg/m	lb/ft			
153	6.0	5508	1238	1989	447	1.7	1.16	1.1	0.76	2	2	2
229	9.0	8244	1853	2977	669	2.6	1.74	1.7	1.14	2	2	2
305	12.0	10980	2468	3965	891	3.4	2.32	2.3	1.52	3	3	2
381	15.0	13716	3083	4953	1113	4.3	2.89	2.8	1.89	3	3	2
457	18.0	16452	3698	5941	1336	5.2	3.47	3.4	2.27	4	4	2
533	21.0	19188	4313	6929	1558	6.0	4.05	3.9	2.65	4	4	2
609	24.0	21924	4929	7917	1780	6.9	4.62	4.5	3.03	5	5	3
685	27.0	24660	5544	8905	2002	7.7	5.20	5.1	3.41	5	5	3
761	30.0	27396	6159	9893	2224	8.6	5.78	5.6	3.78	6	6	3
838	33.0	30168	6782	10894	2449	9.5	6.36	6.2	4.17	6	6	3
914	36.0	32904	7397	11882	2671	10.3	6.94	6.8	4.55	7	7	4
990	39.0	35640	8012	12870	2893	11.2	7.52	7.3	4.92	7	7	4

Additional standard belt widths are available in steps of 76.1 mm (3.00 in). Additional non-standard belt widths are available in steps of 25.4 mm (1.00 in).

1979	77.9	71244	16016	25727	5783	22.4	15.03	14.6	9.84	14	14	7
------	------	-------	-------	-------	------	------	-------	------	------	----	----	---

Additional standard belt widths are available in steps of 76.1 mm (3.00 in). Additional non-standard belt widths are available in steps of 25.4 mm (1.00 in).

2968	116.9	106848	24019	38584	8674	33.5	22.54	22.0	14.76	20	20	10
------	-------	--------	-------	-------	------	------	-------	------	-------	----	----	----

General belt tolerance is +0/-0.4% at 23°C/73°F and 50% RH. For exact belt width contact Customer Service. Non standard belt width on request.

\*Max. Load per Drive Sprocket. Belt material: POM-LF 2000 N (450 lbf), PP 1200 N (270 lbf).

\*\*Max. Spacing between wear strips, Carry: 152 mm (6 in); Return: 304 mm (12 in).

= Single Link



NON STANDARD

STRAIGHT RUNNING

PITCH 38.1 MM/1.50 IN

## Accessories

### Rubber Top

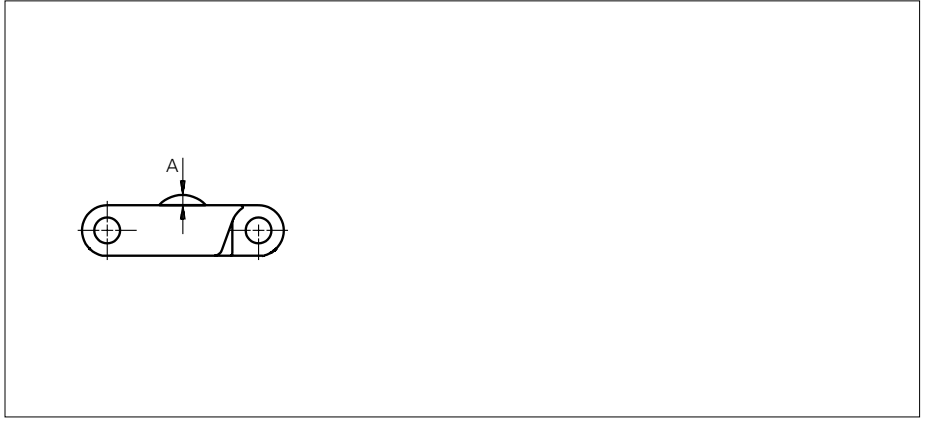

Type	Belt material & color	Rubber material & color	A		Link size	Width	
			mm	in		mm	in
Curved	POM-LF <b>BR</b>	05 <b>I</b>	2.5	0.10	K300	76.0	2.99
					K600	152.2	5.99

Non Standard material and color: See uni Material and Color Overview.

## Accessories

### Flight

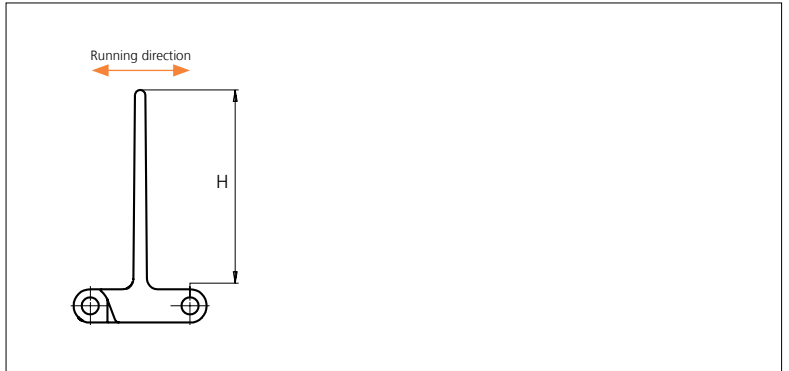
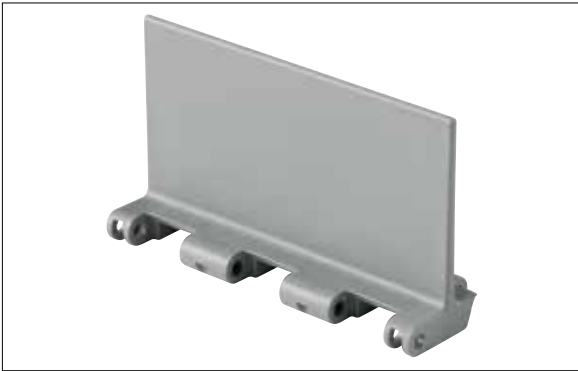

Type	Flight Material & color	H		Link size	Width	
		mm	in		mm	in
Flat	PP-I <b>G</b>	76.1	3.00	K600	152.0	5.99

Non Standard material and color: See uni Material and Color Overview.

Minimum bricklaid indent is for uni SSB Product Support 50.8 mm (2.00 in)

Increment: 25.4 mm (1.00 in)

## Sprocket

No. of teeth	Bore size												Overall diameter		Pitch diameter		Hub diameter		Dimension A		Dimension B		Single row/Two way	Double row/Two way	Molded PA6 LG	Machined PA6 N
	Pilot Bore	in	0.75	0.78	0.98	1.00	1.18	1.25	1.50	1.57	2.36	2.50														
	mm	19.1	20.0	25.0	25.4	30.0	31.8	38.1	40.0	60.0	63.5	90.0	mm	in	mm	in	mm	in	mm	in	mm	in				
Z19	x				●	●	●	■	●				117	4.61	117.3	4.62	75	2.95	49.1	1.93	65	2.56	x	x	x	
Z21	x				●	●	●	■	●				130	5.12	129.3	5.09	75	2.95	55.4	2.18	71	2.80	x	x	x	
Z23	x				●	●	●	■	●				142	5.59	141.2	5.56	75	2.95	61.6	2.43	77	3.03	x	x	x	
Z25	x				●	●	●	■	●				155	6.10	153.2	6.03	75	2.95	67.8	2.67	83	3.27	x	x	x	
Z27	x							●	●	●			167	6.57	165.2	6.5	75	2.95	74	2.91	89	3.50		x		x
Z29	x							●	●	●			179	7.05	177.2	6.98	75	2.95	80.2	3.16	95	3.74		x		x
Z31	x							●	●	●			192	7.56	198.3	7.81	75	2.95	86.4	3.40	101	3.98		x		x

Non standard material and color. See uni Material and Color Overview.

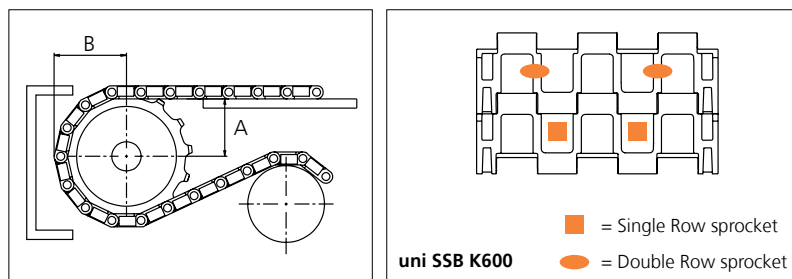

Belt material	POM		PP	
	N	lbf	N	lbf
uni SSB	2000	450	1200	270

Other sprocket sizes are available upon request.  
 Two-part sprocket are available upon request.  
 Round bores are always delivered with keyway.  
 Other bore sizes are available upon request.  
 uni Retainer Rings: See uni Retainer Ring data sheet  
 Width of tooth: 15.0 mm/0.59 in  
 Width of sprocket: Single row = 42.3 mm (1.67 in)  
 Double row = 42.3 mm (1.67 in)

Max load per sprocket shown does not take bore size into account.  
 Please also ensure that sufficient size shaft is chosen for corresponding load.

For correct sprocket position: See uni Assembly Instructions for uni SSB.  
 For more detailed sprocket information, contact Customer Service.



Conveyor Belts



Seamless Belts



Modular Belts



Timing Belts



Transmission Belts



Fabrication & service

Expert advice, quality solutions and local service for all your belting needs [www.ammeraalbeltech.com](http://www.ammeraalbeltech.com)

**Ammeraal Beltech Modular A/S**  
Hjulgagervej 21  
DK-7100 Vejle

T +45 7572 3100  
F +45 7572 3348  
admin@unichains.com  
www.unichains.com

This information is subject to alteration due to continuous development. Ammeraal Beltech will not be held liable for the incorrect use of the above stated information. This information replaces previous information. All activities performed and services rendered by Ammeraal Beltech are subject to general terms and conditions of sale and delivery, as applied by its operating companies.



# Plastic Modular Belt

Series **uni SSB** Type **29%**

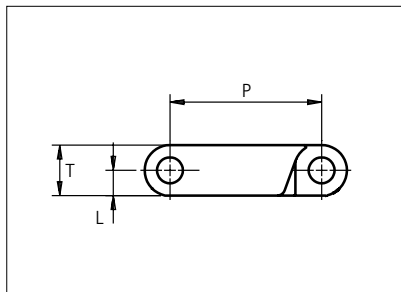

Straight running belt  
 Nominal pitch: 38.1 mm (1.50 in)  
 Surface type: Flat  
 Surface opening: 29%  
 Backflex radius: 45.0 mm (1.8 in)  
 Pin diameter: 6.4 mm (0.25 in)

Recommended belt material & color	POM-LF <b>BR</b>	PP <b>G</b>	mm	in	mm	in
	Recommended pin and lock material & color		P	T	L	
PBT-GR <b>N</b> PP <b>B</b>			38.1	1.50	12.7	0.50
			6.4	0.25	-	-

Non standard material and color: See uni Material and Color Overview.

Alternative pin and lock materials: Pin: PP **W** PA66 **N** SS304

Belt width		Permissible tensile force (Belt/pin material)				Belt weight (Belt/pin material)				*Min. No. drive sprocket per shaft	Number of wear strips (Min. No.)	
		POM-LF/PBT-GR		PP/PBT-GR		POM-LF/PBT-GR		PP/PBT-GR			**Carry (pcs)	**Return (pcs)
mm	in	N	lbf	N	lbf	kg/m	lb/ft	kg/m	lb/ft			
153	6.0	5508	1238	1989	447	1.7	1.16	1.1	0.76	2	2	2
229	9.0	8244	1853	2977	669	2.6	1.74	1.7	1.14	2	2	2
305	12.0	10980	2468	3965	891	3.4	2.32	2.3	1.52	3	3	2
381	15.0	13716	3083	4953	1113	4.3	2.89	2.8	1.89	3	3	2
457	18.0	16452	3698	5941	1336	5.2	3.47	3.4	2.27	4	4	2
533	21.0	19188	4313	6929	1558	6.0	4.05	3.9	2.65	4	4	2
609	24.0	21924	4929	7917	1780	6.9	4.62	4.5	3.03	5	5	3
685	27.0	24660	5544	8905	2002	7.7	5.20	5.1	3.41	5	5	3
761	30.0	27396	6159	9893	2224	8.6	5.78	5.6	3.78	6	6	3
838	33.0	30168	6782	10894	2449	9.5	6.36	6.2	4.17	6	6	3
914	36.0	32904	7397	11882	2671	10.3	6.94	6.8	4.55	7	7	4
990	39.0	35640	8012	12870	2893	11.2	7.52	7.3	4.92	7	7	4

Additional standard belt widths are available in steps of 76.1 mm (3.00 in). Additional non-standard belt widths are available in steps of 25.4 mm (1.00 in).

1979	77.9	71244	16016	25727	5783	22.4	15.03	14.6	9.84	14	14	7
------	------	-------	-------	-------	------	------	-------	------	------	----	----	---

Additional standard belt widths are available in steps of 76.1 mm (3.00 in). Additional non-standard belt widths are available in steps of 25.4 mm (1.00 in).

2968	116.9	106848	24019	38584	8674	33.5	22.54	22.0	14.76	20	20	10
------	-------	--------	-------	-------	------	------	-------	------	-------	----	----	----

General belt tolerance is +0/-0.4% at 23°C/73°F and 50% RH. For exact belt width contact Customer Service. Non standard belt width on request.

\*Max. Load per Drive Sprocket. Belt material: POM-LF 2000 N (450 lbf), PP 1200 N (270 lbf).

\*\*Max. Spacing between wear strips, Carry: 152 mm (6 in); Return: 304 mm (12 in).

= Single Link



NON STANDARD

STRAIGHT RUNNING

PITCH 38.1 MM/1.50 IN

**Accessories**

**NON STANDARD – Rubber Top**

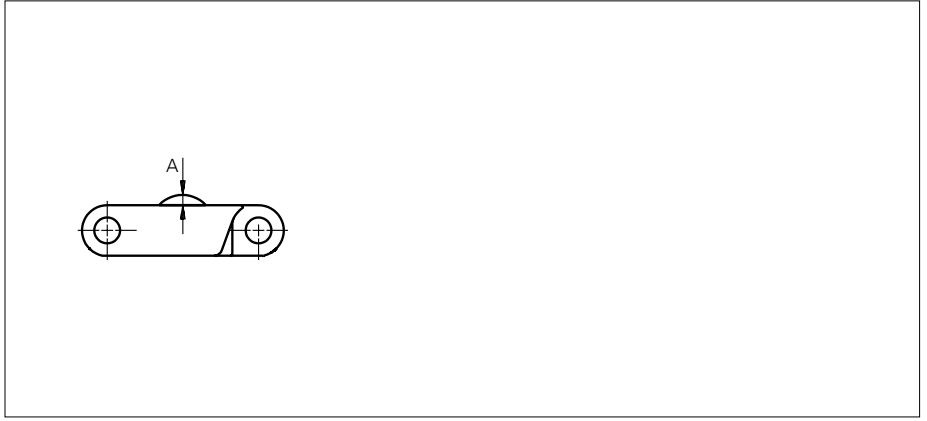

Type	Recommended belt material & color	Recommended rubber material & color	A		Link size	Width	
			mm	in		mm	in
Curved	POM-LF <b>BR</b>	05 <b>I</b>	2.5	0.10	K600	152.2	5.99

Non Standard material and color: See uni Material and Color Overview.

**Accessories**

**Flight**

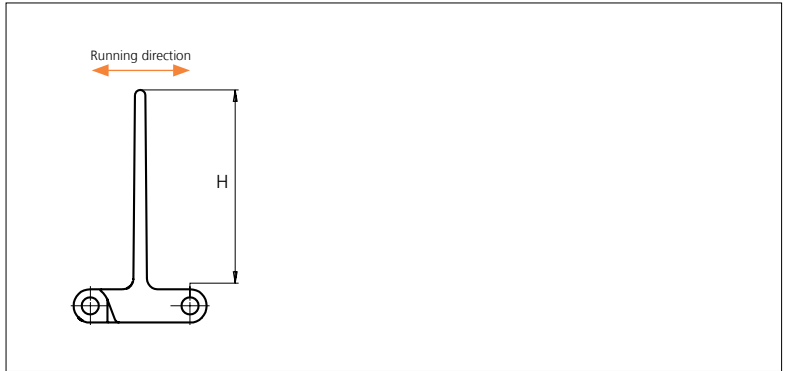

Type	Flight Material & color	H		Link size	Width	
		mm	in		mm	in
Flat	PP-I <b>G</b>	76.1	3.00	K600	152.0	5.99

Non Standard material and color: See uni Material and Color Overview.

Minimum bricklaid indent is for uni SSB Product Support 50.8 mm (2.00 in)

Increment: 25.4 mm (1.00 in)



## Sprocket

No. of teeth	Bore size													Overall diameter		Pitch diameter		Hub diameter		Dimension A		Dimension B		Single row/Two way	Double row/Two way	Molded PA6 LG	Machined PA6 N
	Pilot Bore	in	0.75	0.78	0.98	1.00	1.18	1.25	1.50	1.57	2.36	2.50	3.54														
	mm	19.1	20.0	25.0	25.4	30.0	31.8	38.1	40.0	60.0	63.5	90.0	mm	in	mm	in	mm	in	mm	in							
Z19	x				●	●	●	■	●				117	4.61	117.3	4.62	75	2.95	49.1	1.93	65	2.56	x	x	x		
Z21	x				●	●	●	■	●				130	5.12	129.3	5.09	75	2.95	55.4	2.18	71	2.80	x	x	x		
Z23	x				●	●	●	■	●				142	5.59	141.2	5.56	75	2.95	61.6	2.43	77	3.03	x	x	x		
Z25	x				●	●	●	■	●				155	6.10	153.2	6.03	75	2.95	67.8	2.67	83	3.27	x	x	x		
Z27	x							●	●	●			167	6.57	165.2	6.5	75	2.95	74	2.91	89	3.50		x		x	
Z29	x							●	●	●			179	7.05	177.2	6.98	75	2.95	80.2	3.16	95	3.74		x		x	
Z31	x							●	●	●			192	7.56	198.3	7.81	75	2.95	86.4	3.40	101	3.98		x		x	

Non standard material and color. See uni Material and Color Overview.

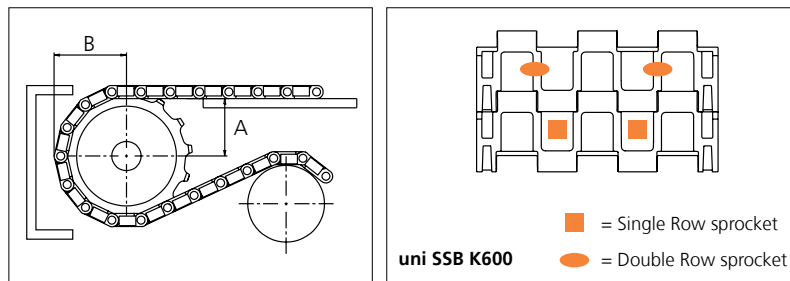
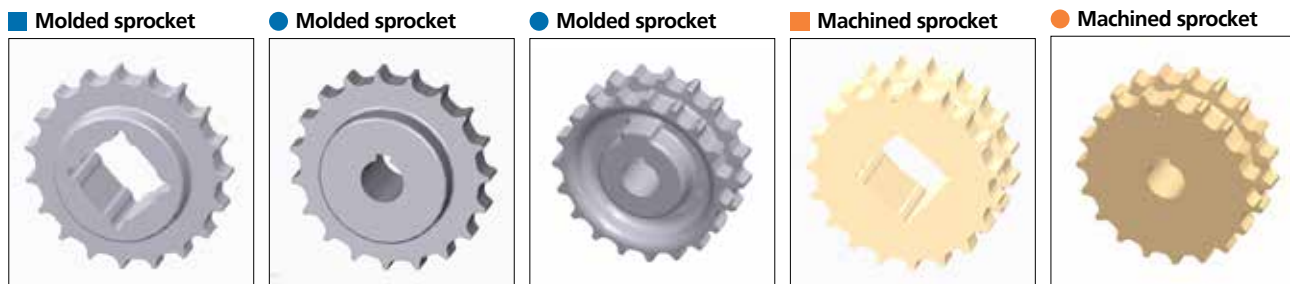

Belt material	POM		PP	
	N	lbf	N	lbf
uni SSB	2000	450	1200	270

Other sprocket sizes are available upon request.  
 Two-part sprocket are available upon request.  
 Round bores are always delivered with keyway.  
 Other bore sizes are available upon request.  
 uni Retainer Rings: See uni Retainer Ring data sheet  
 Width of tooth: 15.0 mm/0.59 in  
 Width of sprocket: Single row = 42.3 mm (1.67 in)  
 Double row = 42.3 mm (1.67 in)

Max. load per sprocket shown does not take bore size into account.  
 Please also ensure that sufficient size shaft is chosen for corresponding load.

For correct sprocket position: See uni Assembly Instructions for uni SSB.  
 For more detailed sprocket information, contact Customer Service.



Conveyor Belts



Seamless Belts

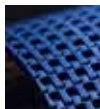

Modular Belts



Timing Belts



Transmission Belts



Fabrication & service

Expert advice, quality solutions and local service for all your belting needs [www.ammeraalbeltech.com](http://www.ammeraalbeltech.com)

**Ammeraal Beltech Modular A/S**  
Hjulmagervej 21  
DK-7100 Vejle

T +45 7572 3100  
F +45 7572 3348  
admin@unichains.com  
www.unichains.com

This information is subject to alteration due to continuous development. Ammeraal Beltech will not be held liable for the incorrect use of the above stated information. This information replaces previous information. All activities performed and services rendered by Ammeraal Beltech are subject to general terms and conditions of sale and delivery, as applied by its operating companies.



# Plastic Modular Belt

Series **uni SSB** Type **32%**

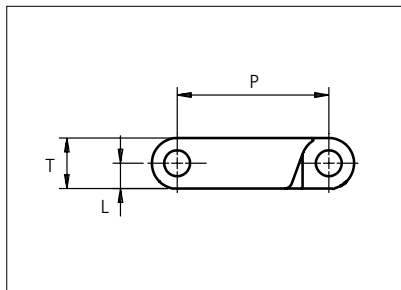
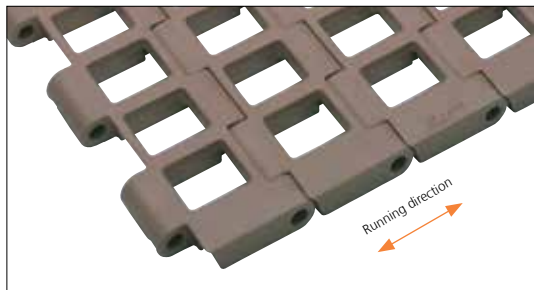

Straight running belt  
 Nominal pitch: 38.1 mm (1.50 in)  
 Surface type: Flat  
 Surface opening: 32%  
 Backflex radius: 45.0 mm (1.8 in)  
 Pin diameter: 6.4 mm (0.25 in)

Recommended belt material & color	POM-LF <b>BR</b>	PP <b>G</b>	mm	in	mm	in
	Recommended pin and lock material & color		P	T	L	
PBT-GR <b>N</b> PP <b>B</b>		PBT-GR <b>N</b> PP <b>B</b>	<b>(Nominal)</b>			
			L			

Non standard material and color: See uni Material and Color Overview.

Alternative pin and lock materials: Pin: PP **W** PA66 SS304

Belt width		Permissible tensile force (Belt/pin material)				Belt weight (Belt/pin material)				*Min. No. drive sprocket per shaft	Number of wear strips (Min. No.)	
		POM-LF/PBT-GR		PP/PBT-GR		POM-LF/PBT-GR		PP/PBT-GR			**Carry (pcs)	**Return (pcs)
mm	in	N	lbf	N	lbf	kg/m	lb/ft	kg/m	lb/ft			
153	6.0	5508	1238	1989	447	1.7	1.16	1.1	0.76	2	2	2
229	9.0	8244	1853	2977	669	2.6	1.74	1.7	1.14	2	2	2
305	12.0	10980	2468	3965	891	3.4	2.32	2.3	1.52	3	3	2
381	15.0	13716	3083	4953	1113	4.3	2.89	2.8	1.89	3	3	2
457	18.0	16452	3698	5941	1336	5.2	3.47	3.4	2.27	4	4	2
533	21.0	19188	4313	6929	1558	6.0	4.05	3.9	2.65	4	4	2
609	24.0	21924	4929	7917	1780	6.9	4.62	4.5	3.03	5	5	3
685	27.0	24660	5544	8905	2002	7.7	5.20	5.1	3.41	5	5	3
761	30.0	27396	6159	9893	2224	8.6	5.78	5.6	3.78	6	6	3
838	33.0	30168	6782	10894	2449	9.5	6.36	6.2	4.17	6	6	3
914	36.0	32904	7397	11882	2671	10.3	6.94	6.8	4.55	7	7	4
990	39.0	35640	8012	12870	2893	11.2	7.52	7.3	4.92	7	7	4

Additional standard belt widths are available in steps of 76.1 mm (3.00 in). Additional non-standard belt widths are available in steps of 25.4 mm (1.00 in).

1979	77.9	71244	16016	25727	5783	22.4	15.03	14.6	9.84	14	14	7
------	------	-------	-------	-------	------	------	-------	------	------	----	----	---

Additional standard belt widths are available in steps of 76.1 mm (3.00 in). Additional non-standard belt widths are available in steps of 25.4 mm (1.00 in).

2968	116.9	106848	24019	38584	8674	33.5	22.54	22.0	14.76	20	20	10
------	-------	--------	-------	-------	------	------	-------	------	-------	----	----	----

General belt tolerance is +0/-0.4% at 23°C/73°F and 50% RH. For exact belt width contact Customer Service. Non standard belt width on request.

\*Max. Load per Drive Sprocket. Belt material: POM-LF 2000 N (450 lbf), PP 1200 N (270 lbf).

\*\*Max. Spacing between wear strips, Carry: 152 mm (6 in); Return: 304 mm (12 in).

= Single Link



NON STANDARD

STRAIGHT RUNNING

PITCH 38.1 MM/1.50 IN

## Accessories

### Rubber Top

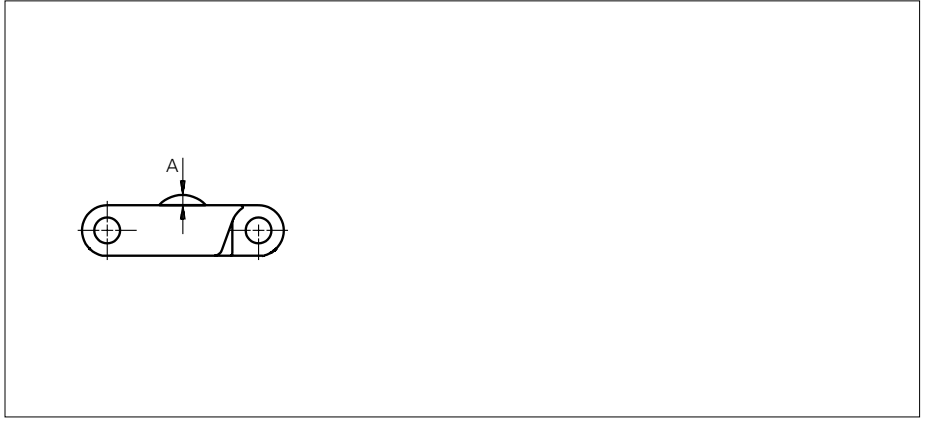

Type	Belt material & color	Rubber material & color	A		Link size	Width	
			mm	in		mm	in
Curved	POM-LF <b>BR</b>	05 <b>I</b>	2.5	0.10	K300	76.0	2.99
					K600	152.2	5.99

Non Standard material and color: See uni Material and Color Overview.

## Accessories

### Flight

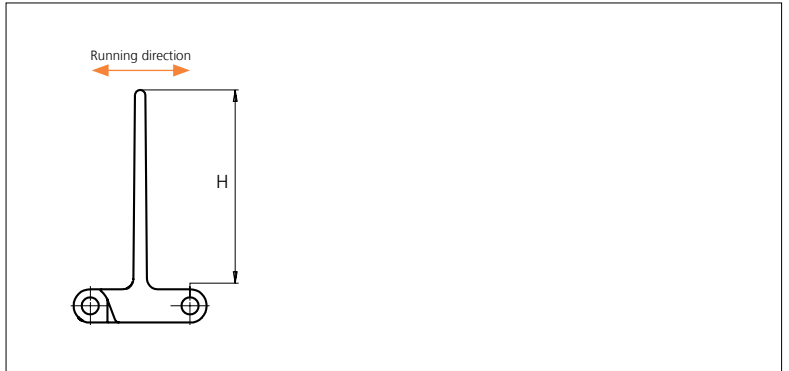
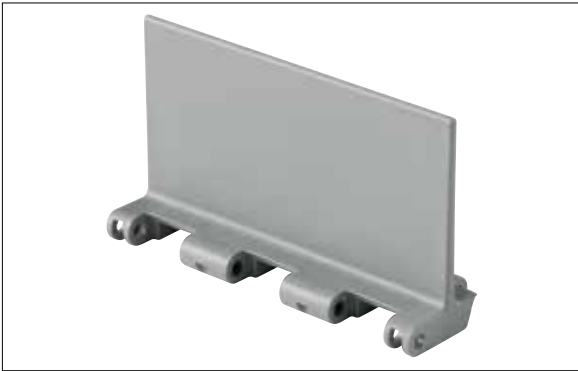

Type	Flight Material & color	H		Link size	Width	
		mm	in		mm	in
Flat	PP-I <b>G</b>	76.1	3.00	K600	152.0	5.99

Non Standard material and color: See uni Material and Color Overview.

Minimum bricklaid indent is for uni SSB Product Support 50.8 mm (2.00 in)

Increment: 25.4 mm (1.00 in)

## Sprocket

No. of teeth	Bore size												Overall diameter		Pitch diameter		Hub diameter		Dimension A		Dimension B		Single row/Two way	Double row/Two way	Molded PA6 LG	Machined PA6 N
	Pilot Bore	in	0.75	0.78	0.98	1.00	1.18	1.25	1.50	1.57	2.36	2.50														
	mm	19.1	20.0	25.0	25.4	30.0	31.8	38.1	40.0	60.0	63.5	90.0	mm	in	mm	in	mm	in	mm	in						
Z19	x				●	●	●	■	●				117	4.61	117.3	4.62	75	2.95	49.1	1.93	65	2.56	x	x	x	
Z21	x				●	●	●	■	●				130	5.12	129.3	5.09	75	2.95	55.4	2.18	71	2.80	x	x	x	
Z23	x				●	●	●	■	●				142	5.59	141.2	5.56	75	2.95	61.6	2.43	77	3.03	x	x	x	
Z25	x				●	●	●	■	●				155	6.10	153.2	6.03	75	2.95	67.8	2.67	83	3.27	x	x	x	
Z27	x							●	●	●			167	6.57	165.2	6.5	75	2.95	74	2.91	89	3.50		x		x
Z29	x							●	●	●			179	7.05	177.2	6.98	75	2.95	80.2	3.16	95	3.74		x		x
Z31	x							●	●	●			192	7.56	198.3	7.81	75	2.95	86.4	3.40	101	3.98		x		x

Non standard material and color. See uni Material and Color Overview.

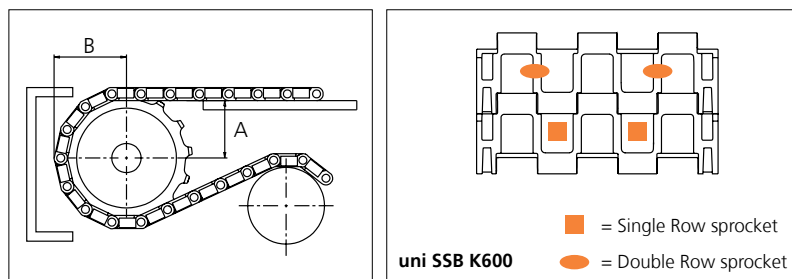

Belt material	POM		PP	
	N	lbf	N	lbf
uni SSB	2000	450	1200	270

Other sprocket sizes are available upon request.

Two-part sprocket are available upon request.

Round bores are always delivered with keyway.

Other bore sizes are available upon request.

uni Retainer Rings: See uni Retainer Ring data sheet.

Width of tooth: 15.0 mm/0.59 in

Width of sprocket: Single row = 42.3 mm (1.67 in)

Double row = 42.3 mm (1.67 in)

Max. load per sprocket shown does not take bore size into account.

Please also ensure that sufficient size shaft is chosen for corresponding load.

For correct sprocket position: See uni Assembly Instructions for uni SSB.

For more detailed sprocket information, contact Customer Service.



Conveyor Belts



Seamless Belts



Modular Belts



Timing Belts



Transmission Belts



Fabrication & service

Expert advice, quality solutions and local service for all your belting needs [www.ammeraalbeltech.com](http://www.ammeraalbeltech.com)

**Ammeraal Beltech Modular A/S**  
Hjulmagervej 21  
DK-7100 Vejle

T +45 7572 3100  
F +45 7572 3348  
admin@unichains.com  
www.unichains.com

This information is subject to alteration due to continuous development. Ammeraal Beltech will not be held liable for the incorrect use of the above stated information. This information replaces previous information. All activities performed and services rendered by Ammeraal Beltech are subject to general terms and conditions of sale and delivery, as applied by its operating companies.



# Plastic Modular Belt

Series **uni X-MPB** Type **C**

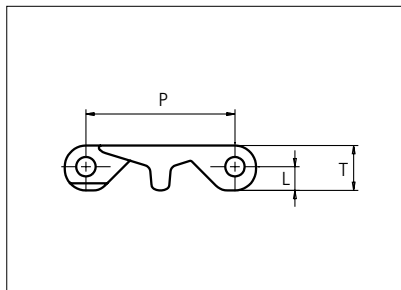

Straight running belt  
 Nominal pitch: 63.5 mm (2.50 in)  
 Surface type: Flat  
 Surface opening: Closed  
 Backflex radius: 75.0 mm (2.95 in)  
 Pin diameter: 8.0 mm (0.31 in)

Belt material & color	POM-DI <b>W</b>	PE-I <b>N</b>	mm	in	mm	in
	Pin and lock material & color		<b>P (Nominal)</b>	63.5	2.50	<b>T</b>
		PA6.6 <b>N</b>	<b>L</b>	10.1	0.40	- / - / -

Non standard material and color: See uni Material and Color Overview.

Alternative pin and lock materials: Lockpin: PP **W** PBT **LG**

Belt width		Permissible tensile force (Belt/pin material)				Belt weight (Belt/pin material)				*Min. No. drive sprocket per shaft	Number of wear strips (Min. No.)	
		POM-DI/PA6.6		PE-I/PA6.6		POM-DI/PA6.6		PE-I/PA6.6			**Carry (pcs)	**Return (pcs)
mm	in	N	lbf	N	lbf	kg/m	lb/ft	kg/m	lb/ft			
76	3.0	2280	513	760	171	1.1	0.75	0.8	0.51	2	2	2
152	6.0	4558	1025	1519	342	2.2	1.49	1.5	1.02	2	2	2
227	9.0	6822	1534	2274	511	3.3	2.23	2.3	1.53	2	2	2
303	11.9	9087	2043	3029	681	4.4	2.97	3.0	2.04	3	3	2
378	14.9	11352	2552	3784	851	5.5	3.71	3.8	2.54	3	3	2
454	17.9	13616	3061	4539	1020	6.6	4.45	4.5	3.05	4	4	2
529	20.8	15881	3570	5294	1190	7.7	5.19	5.3	3.56	4	4	2
605	23.8	18146	4079	6049	1360	8.8	5.93	6.0	4.06	5	5	3
680	26.8	20410	4588	6803	1529	9.9	6.68	6.8	4.57	5	5	3
756	29.8	22675	5097	7558	1699	11.0	7.42	7.6	5.08	6	6	3
831	32.7	24940	5606	8313	1869	12.1	8.16	8.3	5.59	6	6	3
907	35.7	27204	6116	9068	2039	13.2	8.90	9.1	6.09	7	7	4
982	38.7	29469	6625	9823	2208	14.3	9.64	9.8	6.60	7	7	4

Additional standard belt widths are available in steps of 75.5 mm (2.97 in). Additional non-standard belt widths are available in steps of 25.2 mm (0.99 in).

1963	77.3	58890	13238	19630	4413	28.7	19.26	19.6	13.19	14	14	7
------	------	-------	-------	-------	------	------	-------	------	-------	----	----	---

Additional standard belt widths are available in steps of 75.5 mm (2.97 in). Additional non-standard belt widths are available in steps of 25.2 mm (0.99 in).

2945	115.9	88350	19861	29450	6620	43.0	28.90	29.5	19.79	20	20	10
------	-------	-------	-------	-------	------	------	-------	------	-------	----	----	----

General belt tolerance is +0/-0.4% at 23°C/73°F and 50% RH. For exact belt width contact Customer Service. Non standard belt width on request.

\*Max. Load per Drive Sprocket. Belt material: POM-DI 4000 N (899 lbf), PE-I 3000 N (674 lbf).

\*\*Max. Spacing between wear strips, Carry: 152.0 mm (6.00 in); Return: 304.0 mm (12.00 in).

= Single Link



STANDARD

STRAIGHT RUNNING

PITCH 63.5 MM/2.50 IN

## Accessories

### Flight

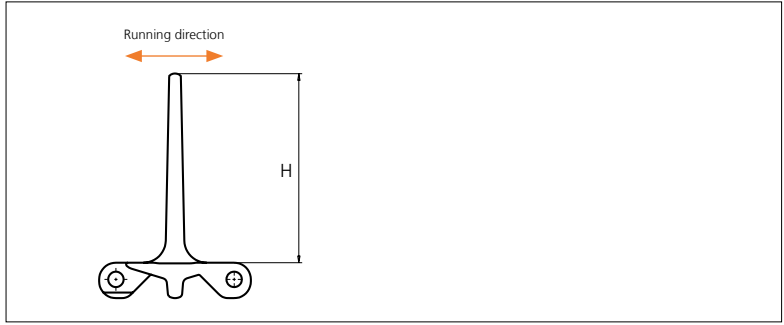

Type	Material & color	H		Link size	Width		Indent	
		mm	in		mm	in	mm	in
Flat	POM-DI <b>W</b>	101.6	4.00	K600	151.0	5.94	0.0	0.00

Non Standard material and color: See uni Material and Color Overview.

### Sprocket

No. of teeth	Bore size						Overall diameter		Pitch diameter		Hub diameter		Dimension A		Dimension B		Double row/Two way	Molded	Machined										
	Pilot Bore	mm	in	1.18	1.25	1.50														1.57	2.50								
Z06	✓	30.0	1.18	●	31.8	1.25	●	38.1	1.50	●	40.0	1.57	●	63.5	2.50	●	124.2	4.89	126.0	4.96	70.0	2.76	44.9	1.77	72.5	2.85	✓	✓	
Z08	✓																165.6	6.52	164.6	6.48	70.0	2.76	66.6	2.62	92.0	3.62	✓	✓	
Z10	✓																206.6	8.13	203.9	8.03	70.0	2.76	87.6	3.45	111.7	4.40	✓	✓	
Z13	✓																267.8	10.54	265.3	10.44	150.0	5.91	118.7	4.67	141.7	5.58	✓		✓

■ Molded sprocket    
 ● Machined sprocket    
 ■ Molded sprocket    
 ● Machined sprocket

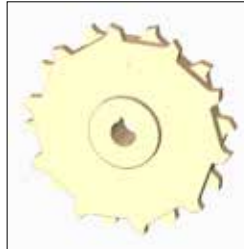

Non standard material and color: See uni Material and Color Overview.

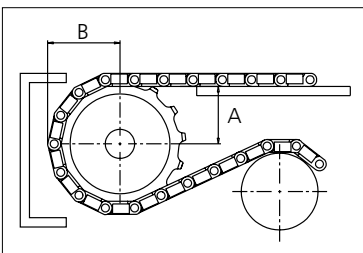

Other sprocket sizes are available upon request.  
 Two-part sprocket are available upon request.  
 Other bore sizes are available upon request.  
 uni Retainer Rings: See uni Retainer Ring data sheet.  
 Width of tooth = 12.0 mm (0.47 in)  
 Width of sprocket = 42.3 mm (1.67 in)

Max load per sprocket shown does not take bore size into account.  
 Please also ensure that sufficient size shaft is chosen for corresponding load.

For correct sprocket position: See uni Assembly Instructions for uni X-MPB.  
 For more detailed sprocket information, contact Customer Service.



Expert advice, quality solutions and local service for all your belting needs  
[www.ammeraalbeltech.com](http://www.ammeraalbeltech.com)

**Ammeraal Beltech Modular A/S**  
 Hjulmagervej 21  
 DK-7100 Vejle

T +45 7572 3100  
 F +45 7572 3348  
 admin@unichains.com  
 www.unichains.com

This information is subject to alteration due to continuous development. Ammeraal Beltech will not be held liable for the incorrect use of the above stated information. This information replaces previous information. All activities performed and services rendered by Ammeraal Beltech are subject to general terms and conditions of sale and delivery, as applied by its operating companies.





# Plastic Modular Belt

Series **uni XLB** Type **M2 C**

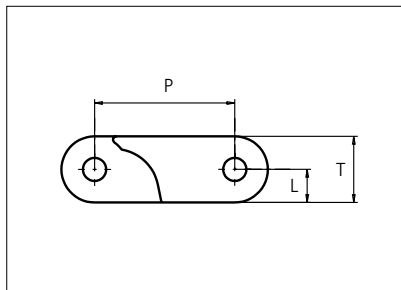

Straight running belt  
 Nominal pitch: 63.5 mm (2.50 in)  
 Surface type: Flat  
 Surface opening: Closed  
 Backflex radius: 100.0 mm (3.90 in)  
 Pin diameter: 10.0 mm (0.39 in)

<b>Belt material &amp; color</b>	POM-NL <b>K</b>		<b>mm</b>	<b>in</b>		<b>mm</b>	<b>in</b>
<b>Pin and lock material &amp; color</b>	PA6.6 <b>N</b> PP <b>D</b>		<b>P (Nominal)</b>	63.5	2.50	<b>T</b>	30.0 1.18
			<b>L</b>	15.0	0.59	-	- -

Non standard material and color: See uni Material and Color Overview.  
 Alternative pin and lock systems and materials: Contact Customer Service.

Belt width		Permissible tensile force (Belt/pin material)				Belt weight (Belt/pin material)				*Min. No. drive sprocket per shaft	Number of wear strips (Min. No.)	
		POM-NL/PA6.6		POM-NL/SS		POM-NL/PA6.6		POM-NL/SS			**Carry (pcs)	**Return (pcs)
mm	in	N	lbf	N	lbf	kg/m	lb/ft	kg/m	lb/ft			
82***	3.2	7560	1699	8400	1888	2.6	1.75	3.4	2.30	2	2	2
101	4.0	9045	2033	10050	2259	3.1	2.09	4.1	2.76	2	2	2
201	7.9	18054	4059	20060	4510	6.2	4.18	8.2	5.50	2	2	2
301	11.8	27063	6084	30070	6760	9.3	6.26	12.3	8.25	3	3	2
401	15.8	36072	8109	40080	9010	12.4	8.35	16.4	10.99	3	3	2
501	19.7	45082	10134	50091	11260	15.5	10.44	20.4	13.73	4	4	2
601	23.7	54091	12160	60101	13511	18.6	12.52	24.5	16.48	5	5	3
701	27.6	63100	14185	70111	15761	21.7	14.61	28.6	19.22	5	5	3
801	31.5	72109	16210	80121	18011	24.8	16.69	32.7	21.97	6	6	3
901	35.5	81118	18235	90131	20261	27.9	18.78	36.8	24.71	7	7	4
1001	39.4	90127	20261	100141	22512	31.0	20.86	40.9	27.46	7	7	4
1102	43.4	99136	22286	110151	24762	34.1	22.95	44.9	30.20	8	8	4

Additional standard belt widths are available in steps of 100.1 mm (3.94 in). Additional non-standard belt widths are available in steps of 33.4 mm (1.31 in).

1902	74.9	171180	38481	190200	42757	59.0	39.63	77.6	52.15	13	13	7
------	------	--------	-------	--------	-------	------	-------	------	-------	----	----	---

Additional standard belt widths are available in steps of 100.1 mm (3.94 in). Additional non-standard belt widths are available in steps of 33.4 mm (1.31 in).

2903	114.3	261270	58733	290300	65259	90.0	60.48	118.4	79.60	20	20	10
------	-------	--------	-------	--------	-------	------	-------	-------	-------	----	----	----

General belt tolerance is +0/-0.4% at 23°C/73°F and 50% RH. For exact belt width contact Customer Service. Non standard belt width on request.

\*Max. Load per Drive Sprocket. Belt material: POM-NL 12000 N (2698 lbf).

\*\*Max. Spacing between wear strips, Carry: 152.0 mm (6.00 in); Return: 304.0 mm (12.00 in).

\*\*\*Type: uni XLB M1 C.

= Single Link



Member of Ammega Group.  
 ammega.com

STANDARD

STRAIGHT RUNNING

PITCH 63.5 MM/2.50 IN

## Accessories

### Rubber Top

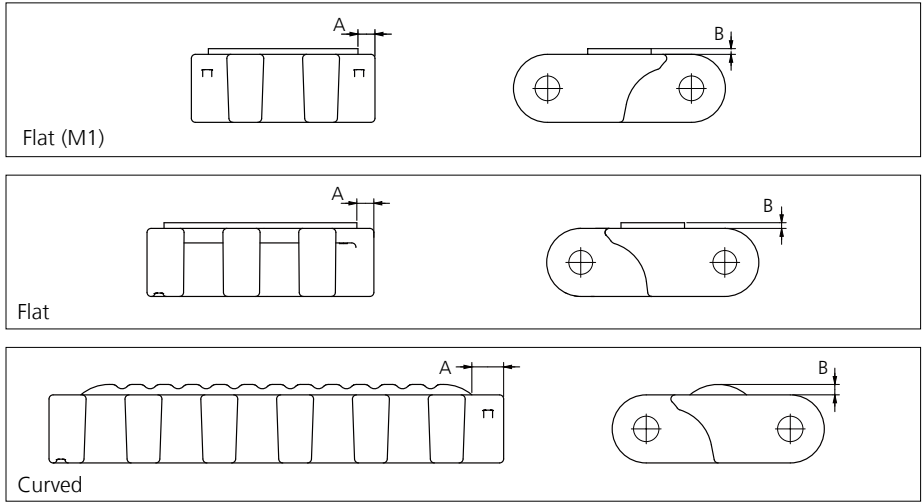

Type	Belt Material & color	Rubber Material & color	A		B		Link size	Width	
			mm	in	mm	in		mm	in
Flat	POM-NL <b>K</b>	05 <b>K</b>	7.5	0.3	2.5	0.10	K318	81.1	3.19
			7.5	0.3	2.5	0.10	K400	100.1	3.94
Curved Rib			14.0	0.58	4.6	0.18	K800	200.2	7.88

Other Non Standard Rubber profiles: See uni Rubber Profile Overview.

## Accessories

### Flight

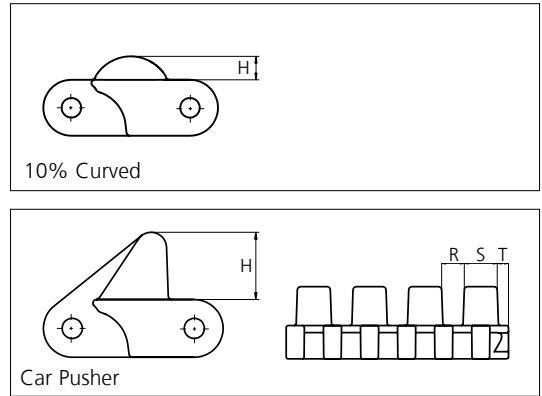
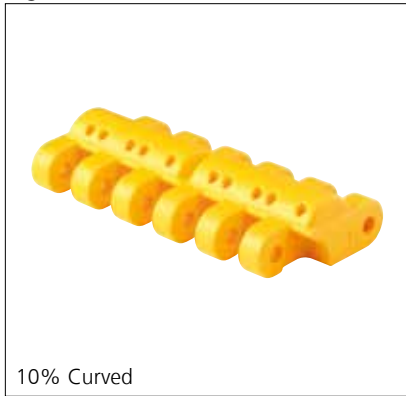

Type	Material & color	H		Link size	Width		R		S		T	
		mm	in		mm	in	mm	in	mm	in	mm	in
10% Curved	POM-D UV <b>Y</b>	12.5	0.49	K400	101.6	4.00	-	-	-	-	-	-
				K800	199.6	7.86	-	-	-	-	-	-
Car Pusher	POM-DK <b>O</b>	35.0	1.38	K800	199.6	7.86	18.1	0.71	32.0	1.26	9.0	0.35

Non Standard material and color: See uni Material and Color Overview.

## Sprocket

No. of teeth	Bore size							Overall diameter		Pitch diameter		Hub diameter		Dimension A		Dimension B		Double row/Two way	Molded PA6 LG	Machined PA6 N
	Pilot Bore	in	1.50	1.57	2.36	2.5	3.54													
			mm	38.1	40.0	60.0	63.5	90.0	mm	in	mm	in	mm	in	mm	in				
Z10	✓		■	■	■	■	■	204.3	8.04	205.5	8.09	100.0	3.94	82.7	3.26	117.8	4.64	✓	✓	
Z13	✓		■	■	■	■	■	264.4	10.41	265.4	10.45	150.0	5.91	113.8	4.48	147.7	5.81	✓	✓	✓
Z15	✓		■	■	■	■	■	306.0	12.05	305.4	12.02	150.0	5.91	134.4	5.29	167.7	6.60	✓	✓	
Z20	✓		■	■	■	■	■	408.0	16.06	406.0	15.98	360.0	14.07	185.5	7.30	218	8.58	✓		✓

■ Molded sprocket

■ Machined sprocket

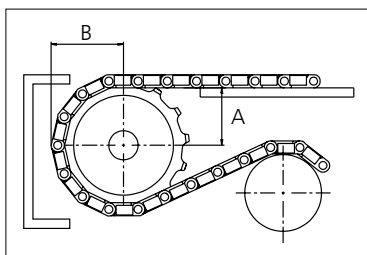
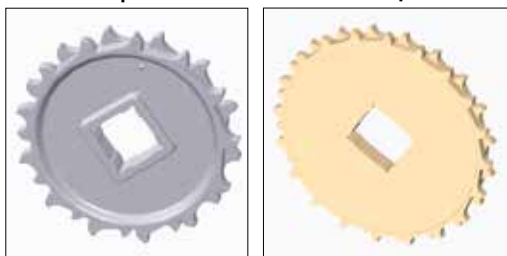

Other sprocket sizes are available upon request.

Two-part sprocket are available upon request.

Other bore sizes are available upon request.

uni Retainer Rings: See uni Retainer Ring data sheet

Width of tooth = 16.0 mm (0.63 in)

Width of sprocket = 33.0 mm (1.30 in)

Max load per sprocket shown does not take bore size into account.

Please also ensure that sufficient size shaft is chosen for corresponding load.

For correct sprocket position: See uni Assembly Instructions for uni XLB.

For more detailed sprocket information, contact Customer Service.

Non standard material and color: See uni Material and Color Overview.



Conveyor Belts



Seamless Belts



Modular Belts



Timing Belts

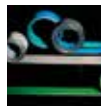

Transmission Belts



Fabrication & service

Expert advice, quality solutions and local service for all your belting needs [www.ammeraalbeltech.com](http://www.ammeraalbeltech.com)

Ammeraal Beltech Modular A/S  
Hjulgagervej 21  
DK-7100 Vejle

T +45 7572 3100  
F +45 7572 3348  
admin@unichains.com  
www.unichains.com

This information is subject to alteration due to continuous development. Ammeraal Beltech will not be held liable for the incorrect use of the above stated information. This information replaces previous information. All activities performed and services rendered by Ammeraal Beltech are subject to general terms and conditions of sale and delivery, as applied by its operating companies.



# Plastic Modular Belt

Series **uni XLB** Type **M2 Rough**

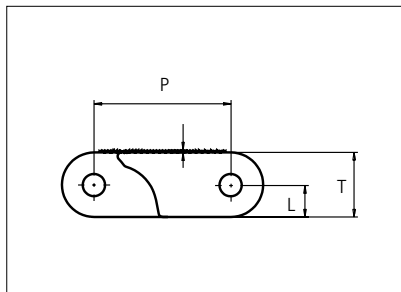

Straight running belt  
 Nominal pitch: 63.5 mm (2.50 in)  
 Surface type: Rough Top  
 Surface opening: Closed  
 Backflex radius: 100.0 mm (3.90 in)  
 Pin diameter: 10.0 mm (0.39 in)

<b>Belt material &amp; color</b>	POM-NL <b>K</b>				
<b>Pin and lock material &amp; color</b>	PA6.6   PP <b>D</b>				
	<b>mm</b>	<b>in</b>		<b>mm</b>	<b>in</b>
<b>P (Nominal)</b>	63.5	2.50	<b>T</b>	30.0	1.18
<b>L</b>	15.0	0.59	-	-	-

Non standard material and color: See uni Material and Color Overview.  
 Alternative pin and lock systems and materials: Contact Customer Service.

Belt width		Permissible tensile force (Belt/pin material)				Belt weight (Belt/pin material)				*Min. No. drive sprocket per shaft	Number of wear strips (Min. No.)	
		POM-NL/PA6.6		POM-NL/SS		POM-NL/PA6.6		POM-NL/SS			**Carry (pcs)	**Return (pcs)
mm	in	N	lbf	N	lbf	kg/m	lb/ft	kg/m	lb/ft			
101	4.0	9045	2033	10050	2259	3.1	2.09	4.1	2.76	2	2	2
201	7.9	18054	4059	20060	4510	6.2	4.18	8.2	5.50	2	2	2
301	11.8	27063	6084	30070	6760	9.3	6.26	12.3	8.25	3	3	2
401	15.8	36072	8109	40080	9010	12.4	8.35	16.4	10.99	3	3	2
501	19.7	45082	10134	50091	11260	15.5	10.44	20.4	13.73	4	4	2
601	23.7	54091	12160	60101	13511	18.6	12.52	24.5	16.48	5	5	3
701	27.6	63100	14185	70111	15761	21.7	14.61	28.6	19.22	5	5	3
801	31.5	72109	16210	80121	18011	24.8	16.69	32.7	21.97	6	6	3
901	35.5	81118	18235	90131	20261	27.9	18.78	36.8	24.71	7	7	4
1001	39.4	90127	20261	100141	22512	31.0	20.86	40.9	27.46	7	7	4
1102	43.4	99136	22286	110151	24762	34.1	22.95	44.9	30.20	8	8	4
1202	47.3	108145	24311	120162	27012	37.3	25.03	49.0	32.95	9	9	5
1302	51.2	117155	26336	130172	29263	40.4	27.12	53.1	35.69	9	9	5

Additional standard belt widths are available in steps of 100.1 mm (3.94 in). Additional non-standard belt widths are available in steps of 33.4 mm (1.31 in).

1902	74.9	171180	38481	190200	42757	59.0	39.63	77.6	52.15	13	13	7
------	------	--------	-------	--------	-------	------	-------	------	-------	----	----	---

Additional standard belt widths are available in steps of 100.1 mm (3.94 in). Additional non-standard belt widths are available in steps of 33.4 mm (1.31 in).

2903	114.3	261270	58733	290300	65259	90.0	60.48	118.4	79.60	20	20	10
------	-------	--------	-------	--------	-------	------	-------	-------	-------	----	----	----

General belt tolerance is +0/-0.4% at 23°C/73°F and 50% RH. For exact belt width contact Customer Service. Non standard belt width on request.

\*Max. Load per Drive Sprocket. Belt material: POM-NL 12000 N (2698 lbf).

\*\*Max. Spacing between wear strips, Carry: 152.0 mm (6.00 in); Return: 304.0 mm (12.00 in).

= Single Link



STANDARD

STRAIGHT RUNNING

PITCH 63.5 MM/2.50 IN

## Accessories

### Rubber Top

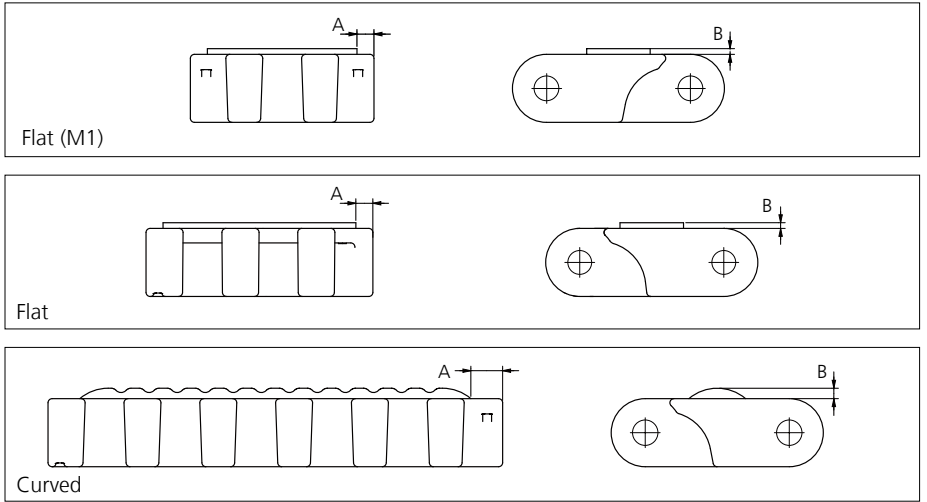

Type	Belt Material & color	Rubber Material & color	A		B		Link size	Width	
			mm	in	mm	in		mm	in
Flat	POM-NL <b>K</b>	05 <b>K</b>	7.5	0.3	2.5	0.10	K318	81.1	3.19
			7.5	0.3	2.5	0.10	K400	100.1	3.94
Curved Rib			14.0	0.58	4.6	0.18	K800	200.2	7.88

Other Non Standard Rubber profiles: See uni Rubber Profile Overview.

## Accessories

### Flight

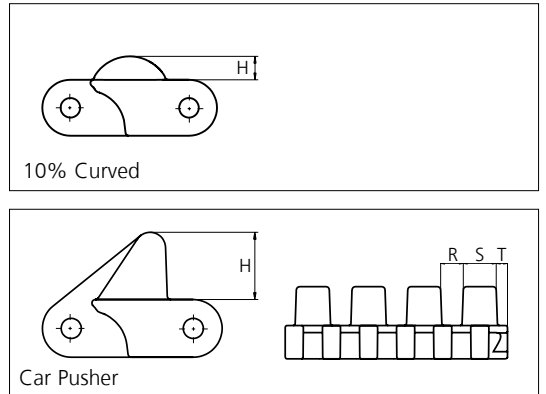

Type	Material & color	H		Link size	Width		R		S		T	
		mm	in		mm	in	mm	in	mm	in	mm	in
10% Curved	POM-D UV <b>Y</b>	12.5	0.49	K400	101.6	4.00	-	-	-	-	-	-
				K800	199.6	7.86	-	-	-	-	-	-
Car Pusher	POM-DK <b>O</b>	35.0	1.38	K800	199.6	7.86	18.1	0.71	32.0	1.26	9.0	0.35

Non Standard material and color: See uni Material and Color Overview.

## Sprocket

No. of teeth	Bore size							Overall diameter		Pitch diameter		Hub diameter		Dimension A		Dimension B		Double row/Two way	Molded PA6 LG	Machined PA6 N
	Pilot Bore	in	1.50	1.57	2.36	2.5	3.54													
			mm	38.1	40.0	60.0	63.5	90.0	mm	in	mm	in	mm	in	mm	in				
Z10	✓		■	■	■	■	■	204.3	8.04	205.5	8.09	100.0	3.94	82.7	3.26	117.8	4.64	✓	✓	
Z13	✓		■	■	■	■	■	264.4	10.41	265.4	10.45	150.0	5.91	113.8	4.48	147.7	5.81	✓	✓	✓
Z15	✓		■	■	■	■	■	306.0	12.05	305.4	12.02	150.0	5.91	134.4	5.29	167.7	6.60	✓	✓	
Z20	✓		■	■	■	■	■	408.0	16.06	406.0	15.98	360.0	14.07	185.5	7.30	218	8.58	✓		✓

■ Molded sprocket

■ Machined sprocket

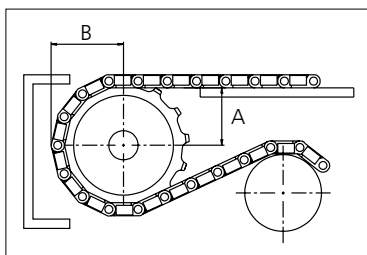
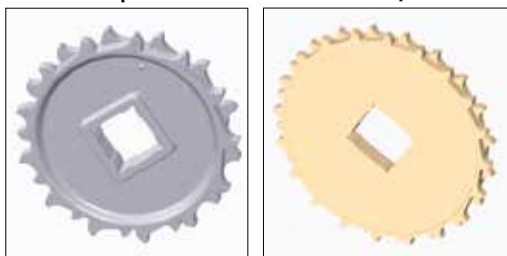

Other sprocket sizes are available upon request.

Two-part sprocket are available upon request.

Other bore sizes are available upon request.

uni Retainer Rings: See uni Retainer Ring data sheet

Width of tooth = 16.0 mm (0.63 in)

Width of sprocket = 33.0 mm (1.30 in)

Max load per sprocket shown does not take bore size into account.

Please also ensure that sufficient size shaft is chosen for corresponding load.

For correct sprocket position: See uni Assembly Instructions for uni XLB.

For more detailed sprocket information, contact Customer Service.

Non standard material and color: See uni Material and Color Overview.



Conveyor Belts



Seamless Belts

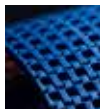

Modular Belts



Timing Belts

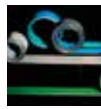

Transmission Belts



Fabrication & service

Expert advice, quality solutions and local service for all your belting needs [www.ammeraalbeltech.com](http://www.ammeraalbeltech.com)

**Ammeraal Beltech Modular A/S**  
Hjulmagervej 21  
DK-7100 Vejle

T +45 7572 3100  
F +45 7572 3348  
admin@unichains.com  
www.unichains.com

This information is subject to alteration due to continuous development. Ammeraal Beltech will not be held liable for the incorrect use of the above stated information. This information replaces previous information. All activities performed and services rendered by Ammeraal Beltech are subject to general terms and conditions of sale and delivery, as applied by its operating companies.





# Plastic Modular Belt

Series **uni XLB** Type **M2 15% Rough**

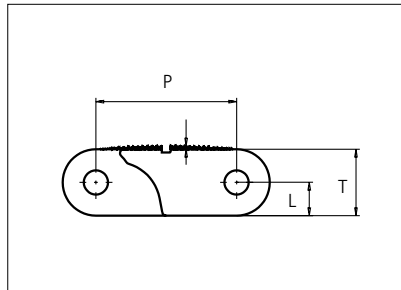

Straight running belt  
 Nominal pitch: 63.5 mm (2.50 in)  
 Surface type: Rough Top  
 Surface opening: 15%  
 Backflex radius: 100.0 mm (3.90 in)  
 Pin diameter: 10.0 mm (0.39 in)

STANDARD

<b>Belt material &amp; color</b>	POM-NL <b>K</b>	mm	in		mm	in
<b>Pin and lock material &amp; color</b>	PA6.6 <b>N</b> PP <b>D</b>	<b>P (Nominal)</b>	63.5	2.50	<b>T</b>	30.0 1.18
		<b>L</b>	15.0	0.59	-	- -

Non standard material and color: See uni Material and Color Overview.  
 Alternative pin and lock systems and materials: Contact Customer Service.

STRAIGHT RUNNING

Belt width		Permissible tensile force (Belt/pin material)				Belt weight (Belt/pin material)				*Min. No. drive sprocket per shaft	Number of wear strips (Min. No.)	
		POM-NL/PA6.6		POM-NL/SS		POM-NL/PA6.6		POM-NL/SS			**Carry (pcs)	**Return (pcs)
mm	in	N	lbf	N	lbf	kg/m	lb/ft	kg/m	lb/ft			
101	4.0	9045	2033	10050	2259	3.1	2.09	4.1	2.76	2	2	2
201	7.9	18054	4059	20060	4510	6.2	4.18	8.2	5.50	2	2	2
301	11.8	27063	6084	30070	6760	9.3	6.26	12.3	8.25	3	3	2
401	15.8	36072	8109	40080	9010	12.4	8.35	16.4	10.99	3	3	2
501	19.7	45082	10134	50091	11260	15.5	10.44	20.4	13.73	4	4	2
601	23.7	54091	12160	60101	13511	18.6	12.52	24.5	16.48	5	5	3
701	27.6	63100	14185	70111	15761	21.7	14.61	28.6	19.22	5	5	3
801	31.5	72109	16210	80121	18011	24.8	16.69	32.7	21.97	6	6	3
901	35.5	81118	18235	90131	20261	27.9	18.78	36.8	24.71	7	7	4
1001	39.4	90127	20261	100141	22512	31.0	20.86	40.9	27.46	7	7	4
1102	43.4	99136	22286	110151	24762	34.1	22.95	44.9	30.20	8	8	4
1202	47.3	108145	24311	120162	27012	37.3	25.03	49.0	32.95	9	9	5
1302	51.2	117155	26336	130172	29263	40.4	27.12	53.1	35.69	9	9	5

Additional standard belt widths are available in steps of 100.1 mm (3.94 in). Additional non-standard belt widths are available in steps of 33.4 mm (1.31 in).

1902	74.9	171180	38481	190200	42757	59.0	39.63	77.6	52.15	13	13	7
------	------	--------	-------	--------	-------	------	-------	------	-------	----	----	---

Additional standard belt widths are available in steps of 100.1 mm (3.94 in). Additional non-standard belt widths are available in steps of 33.4 mm (1.31 in).

2903	114.3	261270	58733	290300	65259	90.0	60.48	118.4	79.60	20	20	10
------	-------	--------	-------	--------	-------	------	-------	-------	-------	----	----	----

General belt tolerance is +0/-0.4% at 23°C/73°F and 50% RH. For exact belt width contact Customer Service. Non standard belt width on request.

\*Max. Load per Drive Sprocket. Belt material: POM-NL 12000 N (2698 lbf).

\*\*Max. Spacing between wear strips, Carry: 152.0 mm (6.00 in); Return: 304.0 mm (12.00 in).

= Single Link

PITCH 63.5 MM/2.50 IN



Member of Ammega Group.  
 ammega.com

## Accessories

### Rubber Top

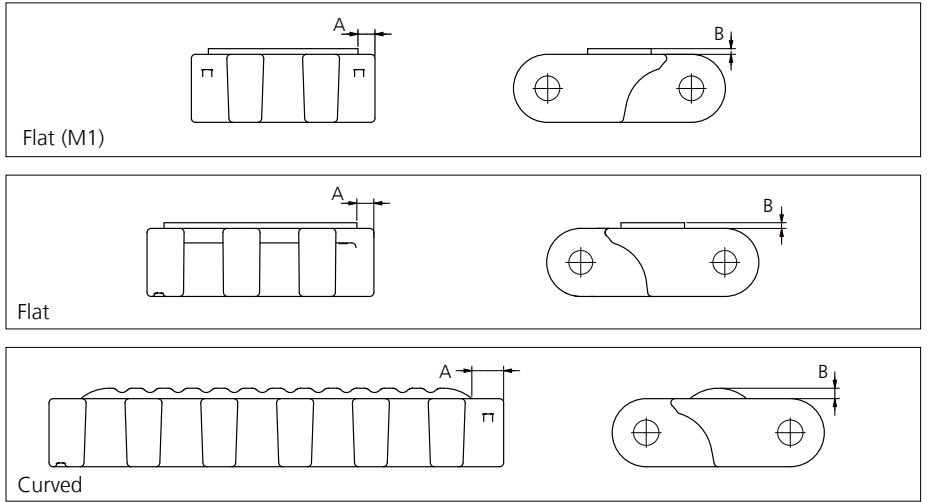

Type	Belt Material & color	Rubber Material & color	A		B		Link size	Width	
			mm	in	mm	in		mm	in
Flat	POM-NL <b>K</b>	05 <b>K</b>	7.5	0.3	2.5	0.10	K318	81.1	3.19
			7.5	0.3	2.5	0.10	K400	100.1	3.94
Curved Rib			14.0	0.58	4.6	0.18	K800	200.2	7.88

Other Non Standard Rubber profiles: See uni Rubber Profile Overview.

## Accessories

### Flight

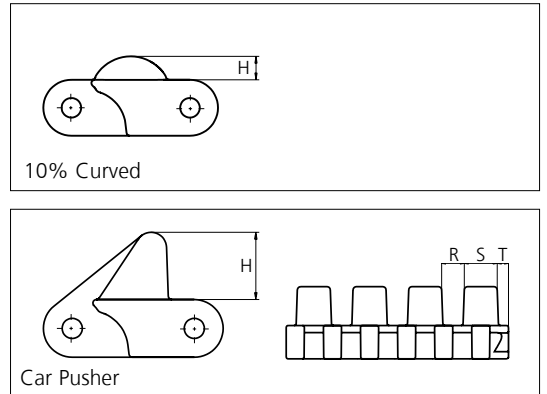

Type	Material & color	H		Link size	Width		R		S		T	
		mm	in		mm	in	mm	in	mm	in	mm	in
10% Curved	POM-D UV <b>Y</b>	12.5	0.49	K400	101.6	4.00	-	-	-	-	-	-
				K800	199.6	7.86	-	-	-	-	-	-
Car Pusher	POM-DK <b>O</b>	35.0	1.38	K800	199.6	7.86	18.1	0.71	32.0	1.26	9.0	0.35

Non Standard material and color: See uni Material and Color Overview.

## Sprocket

No. of teeth	Bore size						Overall diameter		Pitch diameter		Hub diameter		Dimension A		Dimension B		Double row/Two way	Molded	Machined	
	Pilot Bore																			
	mm	in	1.50	1.57	2.36	2.5	3.54	mm	in	mm	in	mm	in	mm	in					
Z10	✓		■	■	■	■	■	204.3	8.04	205.5	8.09	100.0	3.94	82.7	3.26	117.8	4.64	✓	✓	
Z13	✓		■	■	■	■	■	264.4	10.41	265.4	10.45	150.0	5.91	113.8	4.48	147.7	5.81	✓	✓	✓
Z15	✓		■	■	■	■	■	306.0	12.05	305.4	12.02	150.0	5.91	134.4	5.29	167.7	6.60	✓	✓	
Z20	✓		■	■	■	■	■	408.0	16.06	406.0	15.98	360.0	14.07	185.5	7.30	218	8.58	✓		✓

■ Molded sprocket

■ Machined sprocket

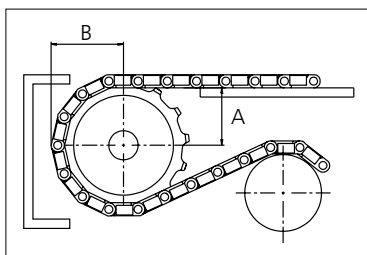
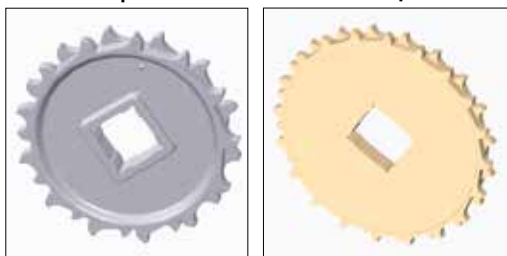

Other sprocket sizes are available upon request.

Two-part sprocket are available upon request.

Other bore sizes are available upon request.

uni Retainer Rings: See uni Retainer Ring data sheet

Width of tooth = 16.0 mm (0.63 in)

Width of sprocket = 33.0 mm (1.30 in)

Max load per sprocket shown does not take bore size into account.

Please also ensure that sufficient size shaft is chosen for corresponding load.

For correct sprocket position: See uni Assembly Instructions for uni XLB.

For more detailed sprocket information, contact Customer Service.

Non standard material and color: See uni Material and Color Overview.



Conveyor Belts



Seamless Belts



Modular Belts



Timing Belts

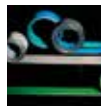

Transmission Belts



Fabrication & service

Expert advice, quality solutions and local service for all your belting needs  
[www.ammeraalbeltech.com](http://www.ammeraalbeltech.com)

**Ammeraal Beltech Modular A/S**  
Hjulgagervej 21  
DK-7100 Vejle

T +45 7572 3100  
F +45 7572 3348  
admin@unichains.com  
www.unichains.com

This information is subject to alteration due to continuous development. Ammeraal Beltech will not be held liable for the incorrect use of the above stated information. This information replaces previous information. All activities performed and services rendered by Ammeraal Beltech are subject to general terms and conditions of sale and delivery, as applied by its operating companies.



# Plastic Modular Belt

Series **uni XLB** Type **M2 V8**

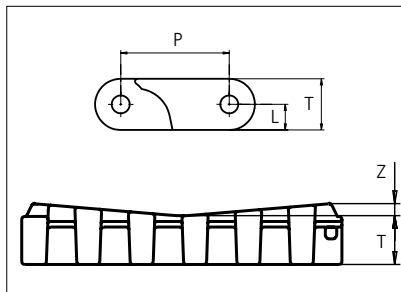

Straight running belt  
 Nominal pitch: 63.5 mm (2.50 in)  
 Surface type: V8  
 Surface opening: Closed  
 Backflex radius: 120.0 mm (4.72 in)  
 Pin diameter: 10.0 mm (0.39 in)

<b>Belt material &amp; color</b>	POM-D <b>K</b>		<b>mm</b>	<b>in</b>		<b>mm</b>	<b>in</b>
<b>Pin and lock material &amp; color</b>	PA6.6 <b>N</b> PP <b>D</b>		<b>P (Nominal)</b>	63.5	2.50	<b>T</b>	30.0 1.18
			<b>L</b>	15.0	0.59	<b>Z</b>	8.0 0.31

Non standard material and color: See uni Material and Color Overview.

Alternative pin and lock materials: Pin: SS304

Belt width		Permissible tensile force (Belt/pin material)				Belt weight (Belt/pin material)				*Min. No. drive sprocket per shaft	Number of wear strips (Min. No.)	
		POM-D/PA6.6		POM-D/SS		POM-D/PA6.6		POM-D/SS			**Carry (pcs)	**Return (pcs)
mm	in	N	lbf	N	lbf	kg/m	lb/ft	kg/m	lb/ft			
201	7.9	18090	4067	20100	4518	6.8	4.58	8.5	5.71	2	2	2
401	15.8	36104	8116	40115	9018	13.6	9.14	17.0	11.40	3	3	2
601	23.7	54117	12166	60130	13517	20.4	13.70	25.4	17.09	5	5	3
801	31.6	72131	16215	80146	18017	27.2	18.26	33.9	22.78	6	6	3

Additional standard belt widths are available in steps of 201 mm (7.91 in) Additional non-standard belt widths are available in steps of 33.4 mm (1.31 in).

General belt tolerance is +0/-0.4% at 23°C/73°F. For exact belt width contact Customer Service. Non standard belt width on request.

\*Max. Load per Drive Sprocket. Belt material: POM-D 12000 N (2698 lbf).

\*\*Max. Spacing between wear strips, Carry: 152.0 mm (6.00 in); Return: 304.0 mm (12.00 in).

= Single Link

STANDARD

STRAIGHT RUNNING

PITCH 63.5 MM/2.50 IN



## Sprocket

No. of teeth	Bore size						Overall diameter		Pitch diameter		Hub diameter		Dimension A		Dimension B		Double row/Two way	Molded	Machined	
	Pilot Bore	in	1.50	1.57	2.36	2.5														3.54
	mm	38.1	40.0	60.0	63.5	90.0	mm	in	mm	in	mm	in	mm	in	mm	in				
Z10	✓		■	■	■	■	■	204.3	8.04	205.5	8.09	100.0	3.94	82.7	3.26	117.8	4.64	✓	✓	
Z13	✓		■	■	■	■	■	264.4	10.41	265.4	10.45	150.0	5.91	113.8	4.48	147.7	5.81	✓	✓	✓
Z15	✓		■	■	■	■	■	306.0	12.05	305.4	12.02	150.0	5.91	134.4	5.29	167.7	6.60	✓	✓	
Z20	✓		■	■	■	■	■	408.0	16.06	406.0	15.98	360.0	14.07	185.5	7.30	218	8.58	✓		✓

■ Molded sprocket

■ Machined sprocket

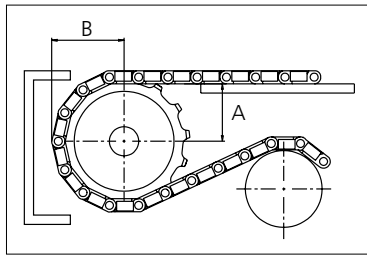
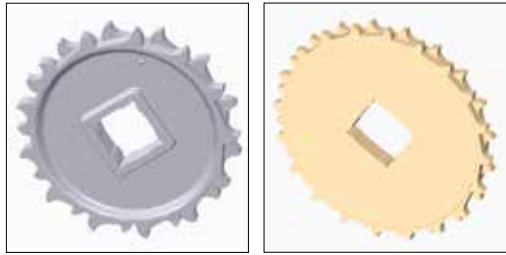

Other sprocket sizes are available upon request.

Two-part sprocket are available upon request.

Other bore sizes are available upon request.

uni Retainer Rings: See uni Retainer Ring data sheet

Width of tooth = 16.0 mm (0.63 in)

Width of sprocket = 33.0 mm (1.30 in)

Max load per sprocket shown does not take bore size into account.

Please also ensure that sufficient size shaft is chosen for corresponding load.

For correct sprocket position: See uni Assembly Instructions for uni XLB.

For more detailed sprocket information, contact Customer Service.

Non standard material and color: See uni Material and Color Overview.



Conveyor Belts



Seamless Belts

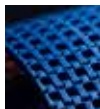

Modular Belts



Timing Belts

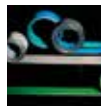

Transmission Belts



Fabrication & service

Solid advice  
For all your belting needs  
Local stock & service  
[www.ammeraalbeltech.com](http://www.ammeraalbeltech.com)

**Ammeraal Beltech Modular A/S**  
Hjulmagervej 21  
DK-7100 Vejle

T +45 7572 3100  
F +45 7572 3348  
admin@unichains.com  
www.unichains.com

This information is subject to alteration due to continuous development. Ammeraal Beltech will not be held liable for the incorrect use of the above stated information. This information replaces previous information. All activities performed and services rendered by Ammeraal Beltech are subject to general terms and conditions of sale and delivery, as applied by its operating companies.

# Local Contacts

Authorised distributor Ammeraal Beltech:

**TYMA CZ, s.r.o.**

Na Pískách 731

400 04 Trmce

Tel:+420 475 655 010

E-mail: [info@tyma.cz](mailto:info@tyma.cz), <http://www.tyma.cz>



Conveyor Belts



Seamless Belts



Modular Belts



Timing Belts



Transmission Belts



Fabrication & service

Expert advice, quality solutions  
and local service  
for all your belting needs  
**[www.ammeraalbeltech.com](http://www.ammeraalbeltech.com)**

**Global Headquarters:**  
**Ammeraal Beltech Holding B.V.**  
P.O. Box 38, 1700 AA Heerhugowaard  
The Netherlands

T +31 72 575 1212  
F +31 72 571 6455  
[info@ammeraalbeltech.com](mailto:info@ammeraalbeltech.com)

This information is subject to alteration due to continuous development. Ammeraal Beltech will not be held liable for the incorrect use of the above stated information. This information replaces previous information. All activities performed and services rendered by Ammeraal Beltech are subject to general terms and conditions of sale and delivery, as applied by its operating companies.