

Product Catalogue 2023/2024

Round and V-belts | monolithic conveyor belts | slip-free belts
Flat belt accessories | coatings | welding equipment



Edition 2023/2024

The specifications

in this catalogue are based on our current knowledge and experience. They do not acquit the processor from testing our products at its own due to the plenty of possible effects during processing application of our products. The legally binding confirmation of certain properties or of the qualification for a certain purpose can not be derived from our specifications. Possible trade mark rights as well as existing laws and regulations are to be followed by recipient of our products at his own responsibility.

Terms and conditions

Our terms and conditions can be found on our homepage under the following link:
<http://www.behabelt.com>

Changes

for the benefit of technical enhancements respectively adoption to modified standards or provisions are provided.

Pictures

in this catalogue are examples of types and are not binding for the type at the time of delivery.

CONTENT

2

ABOUT US

Company // Product groups // Product brands // smart conveying // Fairs/Social Media
Customer Support // Innovations

10

BELT PROFILES MADE OF PU AND TPEE

Round belts// Hollow round belts // Can Cables // Twisted round belts // V-belts
Covered V-belts // Twin-V-belts // Ridge-top-V-belts // T-Profiles // Special profiles
Coatings and embossings for profiles

55

ELASTIC MONOLITHIC CONVEYOR BELTS

Overview structures // Product features // Slip-free conveyor belts
Conveyor belts up to 750, 360 and 140 mm

75

PU COATING MATERIAL

Coating thickness from 1 - 4 mm // Hardness range from Shore 45A to 95A
Coating width from 140 - 750 mm

76

WELDABLE ACCESSORIES FOR CONVEYOR BELTS

V-guides // Cleats // Sidewalls // Belt edges // PU sheets

91

BELT FABRICATION & JOINING

Express service fabrication // Overview joining options // Mechanical joints

96

WELDING TOOLS

Friction welding machines // Hot paddle welding tools // Hot presses // Guide clamps
Welding unit for conveyor belts // Accessories & Spare parts // Mandrel welders
LubeSite® Lubricators

121

KNOW-HOW

Know-how PU and TPE // General directives for plastics // Pulley design //
Guiding concepts for belts AT5 // Pretension // Calculation examples // Technical tables



ABOUT US

Beha Innovation GmbH is a German company based in the heart of Europe.

With a global market presence, a subsidiary in the USA and a worldwide sales network, we serve our customers promptly and competently.

True to the motto „smart conveying“, we have been supplying innovative products for drive and conveyor technology since 1974. Our profiles, belts and welding technology are tailored to market requirements.

A family business

We are a manufacturer

BEHAbelt always wants to offer its customers high-quality and innovative solutions. One of the keys to success here is the close cooperation between sales and production. The belt profiles and conveyor belts are extruded or calendered at our headquarters in Glottertal/Black Forest.

Thanks to the short communication channels, we are able to react quickly to customer requests.

In addition to the high quality of the products, the factors of delivery time and reactivity are top priority in terms of the demands on customer service.



People

People have a decisive influence on quality and innovation - these are our employees, our customers and our suppliers. People are therefore the focus for us and are the basis for a sustainable market partnership.

Quality

High quality raw materials and quality-oriented manufacturing processes result in consistently high quality products. Quality communication and teamwork lead to continued mutual success!

Innovation

We have deep insight into the applications through our customers and our suppliers. We are always developing innovative products and solutions for our customers based on our experience and know-how.



About us

The five product groups of BEHAbelt

Since 1974 we have been dealing with weldable components made of PU and TPE for conveying and power-transmission. Our products and services are always based on market experience and requirements. For us, the partnership and regular exchange with customers and interested parties are the basis for regular product innovations. The belt related challenges have grown and trends have changed over the years. In order to better focus on application requirements, we created the following five product groups.

Conveyor belts

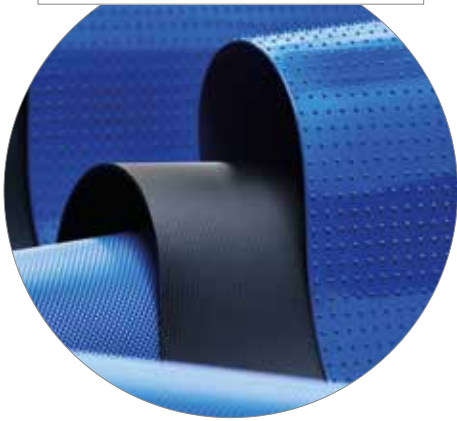

Monolithic conveyor belts made of PU and TPE

We are one of the leading manufacturers offering a huge combination of options. Choose your surface structure, material properties, hardness and colors.

Belt profiles



Weldable PU and TPE belts

BEHAbelt offers one of the broadest ranges in the market. This concerns the number of geometries, material properties and shore hardness variations. In addition, we are able to develop and manufacture customized profiles.

Welding technology



Welding technology for PU and TPE

„Each belt is only as good as its splice.“ Our program includes specially developed welding tools for profiles and flat belts.

Coatings



PU coatings for timing belts and V-belts

Coating materials for e.g. high grip, accumulating or easy release. The industry requirements are as varied as our offer.

Weldable profiles



Weldable profiles made of PU

The assembly of conveyor belts with weld-on profiles such as cleats, sidewalls or V-guides allow solutions to a wide range of applications.

BEHAbelt product labels

Within the product groups of belt profiles, coatings and conveyor belts, we use product labels to identify products with special properties.

Special features of belt profiles and conveyor belts

PU soft

describes a highly flexible, non-slip and wear resistant compound for profiles with a hardness of 65° Shore A. Perfectly suited for applications that require smallest pulley diameters. PUsoft is often used as a silicone alternative.

PU plus

is a special material composition for elevated load capacity and reduced elongation with the same product design and unchanged pulley diameters, compared to products made of standard PU compounds.

PU safe

identifies metal and X-ray detectable conveyor belts and profiles. The food industry is increasingly using detectable profiles and belts as additional safety measure to prevent contamination of foodstuff with foreign objects.

Special features of coatings and weldable profiles

PU tex

Coatings made of these unique PU compounds are fully weldable with the base material and therefore protected against delamination. Due to the high grip they are perfect alternatives to rubber coatings.

PU grip

is our softest coating material. At 45° Shore A hardness it ensures best grip and flexibility. Like all PU coatings, it can be perfectly welded to PU V-belts or timing belts.

PU flex

specifies our extremely flexible sidewalls due to the very small wave pitch. Sidewalls are often used with cleats on conveyors for inclined transport to prevent spillage.

smart conveying

We understand our mission statement as continuous motivation. For us, it means that we always take a critical look at conveying and power-transmission processes. Together with our customers and partners, we want to have constructive conversations to optimize their applications. Doing this, we ensure to develop products and services that will deliver benefits in the target applications.

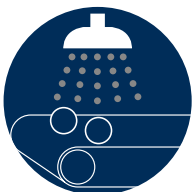

Washing

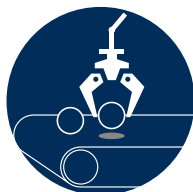

Picking



Cutting

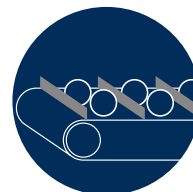

Portioning

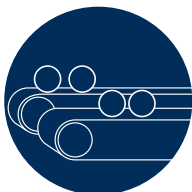

Sorting

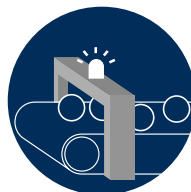

Checking



Weighing

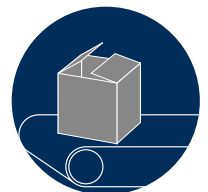

Packing

Contact



Detailed advice by our technical team

We are very interested in our customers' applications so that we can constantly improve them through existing products, the further development of the product range or our know-how. Our technical team consists of experienced engineers and technicians who can advise them comprehensively and also provide with test profiles and conveyor belts.

Very often we advise technical dealers, machine builders or also belt assemblers, but also end users who want to optimise their intralogistic equipment with belt profiles or conveyor belts. Especially the topics of pre-tensioning, belt design, the choice of the right surface structure or the suitable material hardness ensure a process-safe operation of the equipment.

LinkedIn & YouTube

We regularly publish news on LinkedIn. On this platform, we mainly focus on product innovations, event information and tips and tricks.

On the BEHAbelt YouTube channel you will find instructions in the form of videos showing our most important welding equipment and how to use it.



Trade fairs

Participation in trade fairs gives us the opportunity to explain our products individually to customers and evaluate the optimal solution for their specific application. You will find us regularly at the following trade fairs. On request you will receive free trade fair tickets from us.



Newsletter

The free BEHAbelt-Newsletter is published 1-2 times a year and informs about news and trends in the field of conveyor and power-transmission belts as well as our participation in events.

We look forward to your registration.



Contact

Customer Support



Katrin Tüllmann (Inside sales)

Phone: +49 7684 907 160

Fax: +49 7684 907 101

E-Mail: katrin.tuellmann@behabelt.com



Jürgen Strecker (Inside sales)

Phone: +49 7684 907 152

Fax: +49 7684 907 101

E-Mail: juergen.strecker@behabelt.com



Isabell Panameño Salmerón (Inside sales)

Phone: +49 7684 907 151

Fax: +49 7684 907 101

E-Mail: isabell.panameno@behabelt.com



Maria Caputo (Inside sales)

Phone: +49 7684 907 114

Fax: +49 7684 907 101

E-Mail: maria.caputo@behabelt.com



Dennis Hoch (Technical sales)

Phone: +49 7684 907 170

Fax: +49 7684 907 101

E-Mail: dennis.hoch@behabelt.com



Jürgen Gohlke (Sales Manager)

Phone: +49 7684 907 120

Fax: +49 7684 907 101

E-Mail: juergen.gohlke@behabelt.com

Innovations



Elastic monolithic machine tapes

BEHAbelt complements its diverse belt portfolio with the addition of elastic machine tapes made of TPU. Machine tapes have already been established on the market for many years and are often offered in green/black or blue/black versions with antistatic properties. In addition to reinforced belt constructions, elastic versions are also used to adapt to application requirements.

Page 68



Butt splice as a bias angle splice for conveyor belts

While using small pulley diameters it is recommended to use a conveyor belt with a bias angle splice of about 70° (20°) to reduce the stress on the belt splice while bending the splice zone around the pulley.

Such a splice allows to split the bending stress equally on smaller different sections of the belt splice while rolling over the small pulley shape. In generally this offers a better lifetime of the belt especially when using the belt at its recommended mini pulley specification.

Page 114



Expansion of the portfolio for belt edges

In order to be able to meet the different requirements of curved belts, the portfolio of belt edges has been expanded. These flexible and abrasion-resistant profiles are used to stabilise or guide curved belts and are usually sewn and/or glued onto the curved belt.

We also offer customised profiles for this product category.

Page 83



Half-round guide profile for roller conveyors

This specially developed guide profile with its half-round geometry of 9 x 4.5 mm is perfectly matched to the geometry of the round belt groove of roller conveyors and thus offers an abrasion-resistant, guide-optimised and cost-effective belt guide option for the use of flat belts on roller conveyors (belt on roller).

The raw material used is optimally matched to BEHAbelt flat belt qualities for problem-free welding.

Page 80

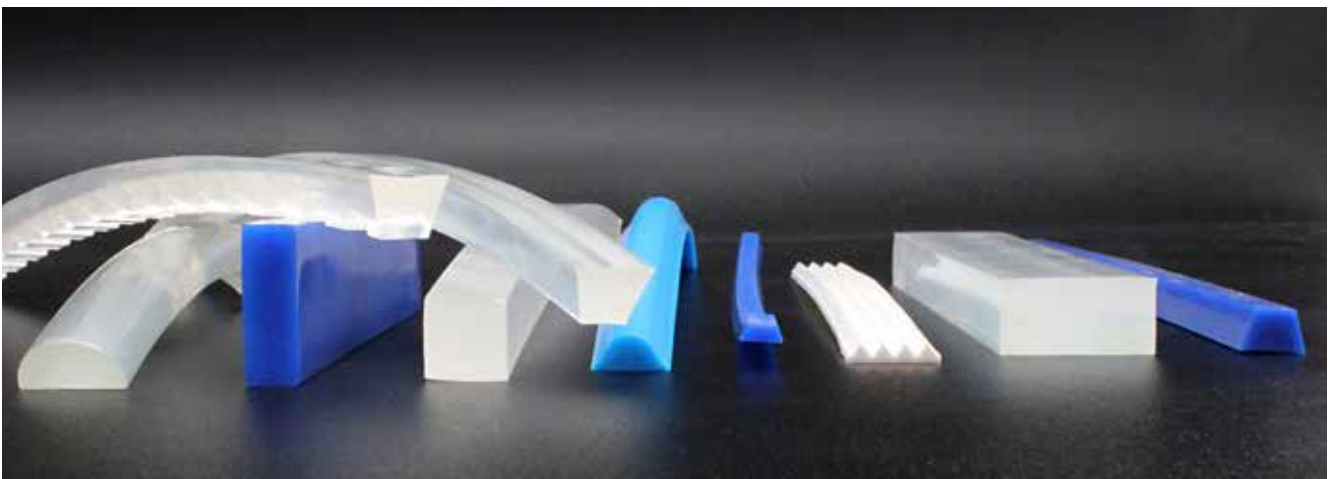

V-guides from 5 x 3 mm & extension weld-on profiles

V-guide profiles are often used as guide profiles on the running side, e.g. to support the straight running of long and/or narrow conveyor belts or to absorb lateral forces when products are fed in from the side.

Page 78



CONVEYOR BELT PROFILES MADE OF PU AND TPE

Table structure key	11
Round belts, Hollow round belts	12
Can Cables	27
Twisted round belts	29
V-belts	30
Coatings and embossings for profiles.....	36
Twin-V-Belts	37
Ridge-top-V-belts.....	39
T-Profiles.....	42
Special profiles / Special V-belts.....	47
Custom-made profiles.....	54

General explanation of the product tables

② PU85A green rough, reinforced aramid



Order No.	⑦ Diameter		⑧ Cross section	⑨ approx. weight	⑩ Standard roll		⑪ Recommended Min. pulley \varnothing		⑫ Fmax/belt (Standard)		⑬ Fmax/belt (Overlap)	
	mm	inch			cm ²	kg/100m	m	ft	mm	inch	kg	lbs
① JZR85A060RA	6,0	7/32	0,283	3,4	100	328	60	2,3	10,2	22,4	30,6	67,3
FBZR85A063RA	6,3	1/4	0,310	3,8	100	328	65	2,5	11,2	24,6	33,6	73,9
FBZR85A070RA	7,0	9/32	0,385	4,7	100	328	70	2,8	13,8	30,4	41,4	91,1
FBZR85A080RA	8,0	5/16	0,500	6,0	100	328	80	3,2	18,0	39,6	54,0	118,8
FBZR85A095RA	9,5	3/8	0,710	8,5	100	328	95	3,7	25,4	55,9	76,2	167,6

④ approx. 88° Shore A

⑤ Recommended pretension 1...2 % ⑥ Coeff. of friction μ : Steel: approx. 0,45 | PE: approx. 0,35 | HDPE: approx. 0,30

Legende

- ① BEHAbelt order number (availability, lead time and minimum order quantity upon request)
- ② BEHAbelt Material Type Quality (Product description)
- ③ Colour (Caution, original colour may deviate from the graphic)
- ④ Approx. specified Shore hardness (Attention! BEHAbelt product description doesn't match the Shore hardness of the belt)
- ⑤ Recommended pretension to tighten the belt in the system (in %) (highest value corresponds to max. preload)
- ⑥ Approx. coefficient of friction μ on steel, PE and HDPE surfaces (Also see coefficient of friction values page 131)
- ⑦ Profile geometry in mm
- ⑧ Material cross-section of the profile (For further details on the calculation, see page 131)
- ⑨ Approx. weight in kg for 100 m of the corresponding profile geometry
- ⑩ Standard roll = Manufacturing unit (smaller amounts available at an upcharge). (Special roll sizes upon request)
- ⑪ Recommended minimum pulley diameter (in mm) measured in neutral fibre. Smaller pulley diameters are possible; however, they can shorten the service life of the belt.
- ⑫ Max. load of the belt (transport load) for butt welding (in kg/belt) (standard case)
- ⑬ Approx. max. load of the belt (standard case) for overlap welding (in kg/belt) (hot-press method HP01, overlap length of 60 mm)

Table values valid at ambient conditions of 20°C ±10°C.
(otherwise minimum pulley diameter, pretension and max. load of the belt have to be adjusted)

Symbols

Antistatic profile with outstanding mechanical properties.	Profile with exceptional low-temperature flexibility down to -30°C.	Patented material formulation „PLUS“ for lower product elongation.	Very good UV resistance.	FDA/EC conformity for hydrolysis-resistant conveying profiles with rough and finely textured surfaces.	Metal and X-ray detectable profiles for maximum food safety.	Hydrolysis resistance (HY). Suitable for humid environments.	Microbe-resistant materials do not provide a breeding ground for microorganisms	Belt made of 2 components enables combination of hardness and features.

Round belts | Shore 65 A, 76 A



Round belts

Weldable round belts made of PU and TPE are available in various Shore hardness grades and diameters for transport and power-transmission. Many belts are food-approved and have various special properties for particularly demanding applications.

Typical industries are: Food, logistics, printing & paper, packaging, building materials and much more.

PU60A **soft** blue smooth



Order No.	Diameter \varnothing		Cross section cm ²	approx. Weight kg/100m	Standard Roll		Recommended Min. pulley \varnothing		Fmax/belt (Standard)	
	mm	inch			m	ft	mm	inch	kg	lbs
FBRF030LGS	3,0	1/8	0,071	0,9	200	656	10	0,4	0,9	2,0
FBRF040LGS	4,0	5/32	0,126	1,6	200	656	20	0,8	1,5	3,3
FBRF050LGS	5,0	1/5	0,181	2,2	100	328	30	1,2	2,2	4,9
FBRF060LGS	6,0	7/32	0,283	3,4	100	328	35	1,4	3,4	7,5
FBRF080LGS	8,0	5/16	0,500	6,0	100	328	45	1,8	6,0	13,2
FBRF095LGS	9,5	3/8	0,710	8,5	100	328	60	2,4	8,5	18,7
FBRF100LGS	10,0	7/16	0,785	9,4	50	164	65	2,6	9,4	20,7

approx. 65° Shore A

Recommended pretension 5...10 %

Coeff. of friction μ : Steel: approx. 0,90 | PE: approx. 0,55 | HDPE: approx. 0,50

FDA/EC compliant (Limited suitability EC)

PU70A ultramarine blue smooth



Order No.	Diameter \varnothing		Cross section cm ²	approx. Weight kg/100m	Standard Roll		Recommended Min. pulley \varnothing		Fmax/belt (Standard)	
	mm	inch			m	ft	mm	inch	kg	lbs
FBRH030LG	3,0	1/8	0,071	0,9	200	656	15	0,6	1,4	3,1
FBRH040LG	4,0	5/32	0,126	1,6	200	656	25	1,0	2,5	5,5
FBRH048LG	4,8	3/16	0,181	2,2	200	656	30	1,2	3,5	7,7
FBRH050LG	5,0	1/5	0,181	2,2	100	328	35	1,4	3,6	7,9
FBRH060LG	6,0	7/32	0,283	3,4	100	328	45	1,8	5,6	12,3
FBRH080LG	8,0	5/16	0,500	6,0	100	328	55	2,2	9,9	21,8

approx. 76° Shore A

Recommended pretension 4...8 %

Coeff. of friction μ : Steel: approx. 0,75 | PE: approx. 0,40 | HDPE: approx. 0,35 | FDA/EC/USDA compliant

PU75A red smooth



Order No.	Diameter Ø		Cross section cm ²	approx. Weight kg/100m	Standard Roll		Recommended Min. pulley Ø		Fmax/belt (Standard)	
	mm	inch			m	ft	mm	inch	kg	lbs
FBRP75A020	2,0	5/64	0,032	0,5	200	656	10	0,4	0,8	1,8
FBRP75A030	3,0	1/8	0,071	0,9	200	656	20	0,8	1,8	4,0
FBRP75A040	4,0	5/32	0,126	1,6	200	656	30	1,2	3,1	6,8
FBRP75A048	4,8	3/16	0,181	2,2	200	656	35	1,4	4,5	9,9
FBRP75A050	5,0	1/5	0,197	2,4	100	328	40	1,6	4,9	10,8
FBRP75A060	6,0	7/32	0,283	3,4	100	328	50	2,0	7,3	16,1
FBRP75A063	6,3	1/4	0,310	3,8	100	328	55	2,2	8,0	17,6
FBRP75A070	7,0	9/32	0,385	4,7	100	328	60	2,4	9,8	21,6
FBRP75A080	8,0	5/16	0,500	6,0	100	328	65	2,6	12,9	28,4
FBRP75A095	9,5	3/8	0,710	8,5	100	328	75	3,0	18,0	39,6
FBRP75A100	10,0	7/16	0,785	9,4	50	164	80	3,2	19,6	43,1
FBRP75A120	12,0	15/32	1,130	13,5	50	164	90	3,5	29,4	64,7
FBRP75A125	12,5	1/2	1,230	14,8	50	164	100	3,9	31,4	69,1
FBRP75A150	15,0	19/32	1,770	21,5	50	164	120	4,7	45,1	99,2
FBRP75A180	18,0	3/4	2,54	31,0	50	164	150	5,9	64,7	142,3
FBRP75A200	20,0	25/32	3,14	40,0	50	164	170	6,7	80,4	176,9

approx. 80° Shore A

Recommended pretension 4...8 %

Coeff. of friction μ : Steel: approx. 0,70 | PE: approx. 0,40 | HDPE: approx. 0,35

PU75A sky blue smooth



Order No.	Diameter Ø		Cross section cm ²	approx. Weight kg/100m	Standard Roll		Recommended Min. pulley Ø		Fmax/belt (Standard)	
	mm	inch			m	ft	mm	inch	kg	lbs
FBRP75A020HI	2,0	5/64	0,032	0,5	200	656	10	0,4	0,8	1,8
FBRP75A030HI	3,0	1/8	0,071	0,9	200	656	20	0,8	1,8	4,0
FBRP75A040HI	4,0	5/32	0,126	1,6	200	656	30	1,2	3,0	6,6
FBRP75A048HI	4,8	3/16	0,181	2,2	200	656	35	1,4	4,4	9,7
FBRP75A050HI	5,0	1/5	0,197	2,4	100	328	40	1,6	4,8	10,6
FBRP75A060HI	6,0	7/32	0,283	3,4	100	328	50	2,0	6,8	15,0
FBRP75A063HI	6,3	1/4	0,310	3,8	100	328	55	2,2	7,4	16,3
FBRP75A070HI	7,0	9/32	0,385	4,7	100	328	60	2,4	9,2	20,2
FBRP75A080HI	8,0	5/16	0,500	6,0	100	328	65	2,6	12,0	26,4
FBRP75A095HI	9,5	3/8	0,710	8,5	100	328	75	3,0	17,0	37,4
FBRP75A100HI	10,0	7/16	0,785	9,4	50	164	80	3,2	18,8	41,4
FBRP75A120HI	12,0	15/32	1,130	13,5	50	164	90	3,5	27,2	59,8
FBRP75A125HI	12,5	1/2	1,230	14,8	50	164	100	3,9	29,6	65,1
FBRP75A150HI	15,0	19/32	1,770	21,5	50	164	120	4,7	42,4	93,3

approx. 80° Shore A

Recommended pretension 4...8 %

Coeff. of friction μ : Steel: approx. 0,70 | PE: approx. 0,40 | HDPE: approx. 0,35 | FDA/EC/USDA compliant

PU75A **plus** orange matt



Order No.	Diameter \varnothing		Cross section cm ²	approx. Weight kg/100m	Standard Roll		Recommended Min. pulley \varnothing		Fmax/belt (Standard)	
	mm	inch			m	ft	mm	inch	kg	lbs
FBRI0200G	2,0	5/64	0,032	0,5	200	656	10	0,4	0,9	2,0
FBRI0300G	3,0	1/8	0,071	0,9	200	656	20	0,8	1,8	4,0
FBRI0400G	4,0	5/32	0,126	1,6	200	656	30	1,2	3,6	7,9
FBRI0480G	4,8	3/16	0,181	2,2	200	656	35	1,4	5,2	11,4
FBRI0500G	5,0	1/5	0,197	2,4	100	328	40	1,6	5,7	12,5
FBRI0600G	6,0	7/32	0,283	3,4	100	328	50	2,0	8,1	17,8
FBRI0630G	6,3	1/4	0,310	3,8	100	328	55	2,2	8,9	19,6
FBRI0700G	7,0	9/32	0,385	4,7	100	328	60	2,4	11,1	24,4
FBRI0800G	8,0	5/16	0,500	6,0	100	328	65	2,6	14,4	31,7
FBRI0950G	9,5	3/8	0,710	8,5	100	328	75	3,0	20,4	44,9
FBRI1000G	10,0	7/16	0,785	9,4	50	164	80	3,2	22,6	49,7

approx. 80° Shore A

Recommended pretension 3...6 %

Coeff. of friction μ : Steel: approx. 0,70 | PE: approx. 0,40 | HDPE: approx. 0,35

PU80A transparent smooth



Order No.	Diameter \varnothing		Cross section cm ²	approx. Weight kg/100m	Standard Roll		Recommended Min. pulley \varnothing		Fmax/belt (Standard)	
	mm	inch			m	ft	mm	inch	kg	lbs
FBRP80A020TR	2,0	5/64	0,032	0,5	200	656	15	0,6	1,1	2,4
FBRP80A030TR	3,0	1/8	0,071	0,9	200	656	25	1,0	2,1	4,6
FBRP80A040TR	4,0	5/32	0,126	1,6	200	656	30	1,2	4,1	9,0
FBRP80A048TR	4,8	3/16	0,181	2,2	200	656	40	1,6	5,8	12,8
FBRP80A050TR	5,0	1/5	0,197	2,4	100	328	45	1,8	6,2	13,6
FBRP80A060TR	6,0	7/32	0,283	3,4	100	328	55	2,2	9,0	19,8
FBRP80A063TR	6,3	1/4	0,310	3,8	100	328	60	2,4	10,1	22,1
FBRP80A070TR	7,0	9/32	0,385	4,7	100	328	65	2,6	12,4	27,3
FBRP80A080TR	8,0	5/16	0,500	6,0	100	328	75	3,0	16,1	35,3
FBRP80A095TR	9,5	3/8	0,710	8,5	100	328	90	3,5	22,7	49,9
FBRP80A100TR	10,0	7/16	0,785	9,4	50	164	95	3,7	25,3	55,6
FBRP80A120TR	12,0	15/32	1,130	13,5	50	164	110	4,3	36,4	80,0
FBRP80A125TR	12,5	1/2	1,230	14,8	50	164	115	4,5	39,4	86,6
FBRP80A150TR	15,0	19/32	1,770	21,5	50	164	140	5,5	56,7	124,8
FBRP80A180TR	18,0	3/4	2,54	31,0	50	164	170	6,7	81,5	179,4
FBRP80A200TR	20,0	25/32	3,14	40,0	50	164	180	7,1	100,6	221,3

approx. 84° Shore A

Recommended pretension 4...8 %

Coeff. of friction μ : Steel: approx. 0,65 | PE: approx. 0,35 | HDPE: approx. 0,30 | FDA/EC/USDA compliant

PU80A ultramarine blue smooth



Order No.	Diameter \varnothing		Cross section cm ²	approx. Weight kg/100m	Standard Roll		Recommended Min. pulley \varnothing		Fmax/belt (Standard)	
	mm	inch			m	ft	mm	inch	kg	lbs
FBRP80A020UB	2,0	5/64	0,032	0,5	200	656	15	0,6	0,9	2,0
FBRP80A030UB	3,0	1/8	0,071	0,9	200	656	25	1,0	2,2	4,8
FBRP80A040UB	4,0	5/32	0,126	1,6	200	656	30	1,2	3,9	8,6
FBRP80A048UB	4,8	3/16	0,181	2,2	200	656	40	1,6	5,5	12,1
FBRP80A050UB	5,0	1/5	0,197	2,4	100	328	45	1,8	6,1	13,4
FBRP80A060UB	6,0	7/32	0,283	3,4	100	328	55	2,2	8,7	19,1
FBRP80A063UB	6,3	1/4	0,310	3,8	100	328	60	2,4	9,6	21,1
FBRP80A070UB	7,0	9/32	0,385	4,7	100	328	65	2,6	11,8	26,0
FBRP80A080UB	8,0	5/16	0,500	6,0	100	328	75	3,0	15,3	33,7
FBRP80A095UB	9,5	3/8	0,710	8,5	100	328	90	3,6	21,6	47,5
FBRP80A100UB	10,0	7/16	0,785	9,4	50	164	95	3,8	24,0	52,8
FBRP80A120UB	12,0	15/32	1,130	13,5	50	164	110	4,4	34,4	75,7
FBRP80A125UB	12,5	1/2	1,230	14,8	50	164	115	4,6	37,5	82,5
FBRP80A150UB	15,0	19/32	1,770	21,5	50	164	140	5,5	54,1	119,0

approx. 84° Shore A

Recommended pretension 4...8 %

Coeff. of friction μ : Steel: approx. 0,65 | PE: approx. 0,35 | HDPE: approx. 0,30 | FDA/EC/USDA compliant

PU80A ultramarine blue slightly rough



Order No.	Diameter \varnothing		Cross section cm ²	approx. Weight kg/100m	Standard Roll		Recommended Min. pulley \varnothing		Fmax/belt (Standard)	
	mm	inch			m	ft	mm	inch	kg	lbs
FBRP80A020BA	2,0	5/64	0,032	0,5	200	656	15	0,6	0,9	2,0
FBRP80A030BA	3,0	1/8	0,071	0,9	200	656	25	1,0	2,2	4,8
FBRP80A040BA	4,0	5/32	0,126	1,6	200	656	30	1,2	3,9	8,6
FBRP80A048BA	4,8	3/16	0,181	2,2	200	656	40	1,6	5,5	12,1
FBRP80A050BA	5,0	1/5	0,197	2,4	100	328	45	1,8	6,1	13,4
FBRP80A060BA	6,0	7/32	0,283	3,4	100	328	55	2,2	8,7	19,1
FBRP80A063BA	6,3	1/4	0,310	3,8	100	328	60	2,4	9,6	21,1
FBRP80A070BA	7,0	9/32	0,385	4,7	100	328	65	2,6	11,8	26,0
FBRP80A080BA	8,0	5/16	0,500	6,0	100	328	75	3,0	15,3	33,7
FBRP80A095BA	9,5	3/8	0,710	8,5	100	328	90	3,6	21,6	47,5
FBRP80A100BA	10,0	7/16	0,785	9,4	50	164	95	3,8	24,0	52,8
FBRP80A120BA	12,0	15/32	1,130	13,5	50	164	110	4,4	34,4	75,7
FBRP80A125BA	12,5	1/2	1,230	14,8	50	164	115	4,6	37,5	82,5
FBRP80A150BA	15,0	19/32	1,770	21,5	50	164	140	5,5	54,1	119,0

approx. 84° Shore A

Recommended pretension 4...8 %

Coeff. of friction μ : Steel: approx. 0,55 | PE: approx. 0,30 | HDPE: approx. 0,25 | FDA/EC compliant

PU80A orange smooth



Order No.	Diameter \varnothing		Cross section cm ²	approx. Weight kg/100m	Standard Roll		Recommended Min. pulley \varnothing		Fmax/belt (Standard)	
	mm	inch			m	ft	mm	inch	kg	lbs
FBRP84A020	2,0	5/64	0,032	0,5	30	100	15	0,6	1,1	2,4
FBRP84A032	3,2	1/8	0,071	0,9	30	100	25	1,0	2,1	4,7
FBRP84A032A	3,2	1/8	0,071	0,9	152	500	25	1,0	2,2	4,9
FBRP84A040	4,0	5/32	0,126	1,6	30	100	30	1,2	4,1	8,9
FBRP84A048	4,8	3/16	0,181	2,2	30	100	40	1,6	5,8	12,7
FBRP84A048A	4,8	3/16	0,181	2,2	152	500	40	1,6	5,8	12,7
FBRP84A050	5,0	1/5	0,197	2,4	30	100	45	1,8	6,2	13,7
FBRP84A060	6,0	7/32	0,283	3,4	30	100	55	2,2	9,0	19,8
FBRP84A063	6,3	1/4	0,310	3,8	30	100	60	2,4	10,1	22,1
FBRP84A063A	6,3	1/4	0,310	3,8	152	500	60	2,4	10,1	22,1
FBRP84A070	7,0	9/32	0,385	4,7	30	100	65	2,6	12,4	27,3
FBRP84A079	7,9	5/16	0,500	6,0	30	100	75	3,0	16,1	35,3
FBRP84A079A	7,9	5/16	0,500	6,0	152	500	75	3,0	16,1	35,3
FBRP84A095	9,5	3/8	0,710	8,5	30	100	90	3,5	22,7	49,9
FBRP84A095A	9,5	3/8	0,710	8,5	152	500	90	3,5	22,7	49,9
FBRP84A100	10,0	7/16	0,785	9,4	30	100	95	3,7	25,3	55,6
FBRP84A120	12,0	15/32	1,130	13,5	30	100	110	4,3	36,4	80,0
FBRP84A127	12,7	1/2	1,230	14,8	30	100	115	4,5	39,4	86,6
FBRP84A143	14,3	9/16	1,605	21,0	30	100	130	5,1	49,4	108,8
FBRP84A159	15,9	6/8	1,985	22,5	30	100	150	5,9	64,2	141,2
FBRP84A190	19,0	3/4	2,83	31,0	30	100	170	6,7	91,0	200,1

approx. 84° Shore A

Recommended pretension 4...8 %

Coeff. of friction μ : Steel: approx. 0,65 | PE: approx. 0,35 | HDPE: approx. 0,30 | FDA/EC/USDA compliant

PU80A orange smooth, reinforced Polyester



Order No.	Diameter \varnothing		Cross section cm ²	approx. weight kg/100m	Standard Roll		Recommended Min. pulley \varnothing *		Fmax/belt (Standard)		Fmax/Belt (Overlap)	
	mm	inch			m	ft	mm	inch	kg	lbs	kg	lbs
FBRJ0600GA	6,0	7/32	0,283	3,4	30	100	55	2,2	9,0	19,8	18,9	41,6
FBRJ0630GA	6,3	1/4	0,310	3,8	30	100	60	2,4	10,1	22,1	21,2	46,5
FBRJ0700GA	7,0	9/32	0,385	4,7	30	100	65	2,6	12,4	27,3	25,4	55,9
FBRJ0800GA	8,0	5/16	0,500	6,0	30	100	80	3,2	16,1	35,3	33,8	74,3
FBRJ0950GA	9,5	3/8	0,710	8,5	30	100	90	3,6	22,7	49,9	47,7	104,9
FBRJ1000GA	10,0	7/16	0,785	9,4	30	100	100	4	25,3	55,6	53,1	116,8
FBRJ1200GA	12,0	15/32	1,130	13,5	30	100	110	4,4	36,4	80,0	76,5	168,3
FBRJ1250GA	12,5	1/2	1,230	14,8	30	100	115	4,6	39,4	86,6	82,8	182,2
FBRJ1430GA	14,3	9/16	1,605	21,0	30	100	130	5,2	49,4	108,8	104,0	228,7
FBRJ1900GA	19,0	3/4	2,83	31,0	30	100	170	6,8	91,0	200,1	191,3	420,8
FBRJ2000GA	20,0	25/32	3,14	40,0	30	100	190	7,6	100,6	221,3	211,5	465,3

approx. 84° Shore A

Recommended pretension

0,5...2 %

Coeff. of friction μ : Steel: approx. 0,65 | PE: approx. 0,35 | HDPE: approx. 0,30 | FDA/EC/USDA compliant

*For overlap welding, the recommended minimum pulley diameter must be increased by +30%.

PU80A **safe** capri blue smooth



Metal and X-ray detectable belt

Order No.	Diameter Ø		Cross section cm ²	approx. Weight kg/100m	Standard Roll		Recommended Min. pulley Ø		Fmax/belt (Standard)	
	mm	inch			m	ft	mm	inch	kg	lbs
FBRJ020LGM	2,0	5/64	0,032	0,5	200	656	15	0,6	0,6	1,3
FBRJ030LGM	3,0	1/8	0,071	0,9	200	656	25	1,0	1,6	3,5
FBRJ032LGM	3,2	1/8	0,071	0,9	30	100	25	1,0	1,7	3,7
FBRJ040LGM	4,0	5/32	0,126	1,6	200	656	30	1,2	2,9	6,4
FBRJ048LGM	4,8	3/16	0,181	2,2	30	100	40	1,6	4,0	8,8
FBRJ050LGM	5,0	1/5	0,197	2,4	100	328	45	1,8	5,6	12,3
FBRJ060LGM	6,0	7/32	0,283	3,4	100	328	55	2,2	6,4	14,1
FBRJ063LGM	6,3	1/4	0,310	3,8	30	100	60	2,4	6,9	15,2
FBRJ070LGM	7,0	9/32	0,385	4,7	100	328	65	2,6	9,3	20,5
FBRJ079LGM	7,9	5/16	0,500	6,0	30	100	75	3,0	12,0	26,4
FBRJ080LGM	8,0	5/16	0,500	6,0	100	328	75	3,0	12,0	26,4
FBRJ095LGM	9,5	3/8	0,710	8,5	30	100	90	3,5	17,0	37,4
FBRJ100LGM	10,0	7/16	0,785	9,4	50	164	95	3,7	18,9	41,6
FBRJ120LGM	12,0	15/32	1,130	13,5	50	164	110	4,3	27,2	59,9
FBRJ125LGM	12,5	1/2	1,230	14,8	30	100	115	4,5	29,4	64,7
FBRJ143LGM	14,3	9/16	1,605	21,0	30	100	130	5,1	37,0	81,4
FBRJ150LGM	15,0	19/32	1,770	21,5	50	164	140	5,5	42,4	93,3

approx. 84° Shore A

Recommended pretension 3...6 %

Coeff. of friction μ : Steel: approx. 0,65 | PE: approx. 0,35 | HDPE: approx. 0,30 | FDA/EC/USDA compliant

PU85A green smooth



Order No.	Diameter Ø		Cross section cm ²	approx. Weight kg/100m	Standard Roll		Recommended Min. pulley Ø		Fmax/belt (Standard)	
	mm	inch			m	ft	mm	inch	kg	lbs
FBRP85A020	2,0	5/64	0,032	0,5	200	656	15	0,6	1,2	2,7
FBRP85A030	3,0	1/8	0,071	0,9	200	656	25	1	2,7	5,8
FBRP85A040	4,0	5/32	0,126	1,6	200	656	35	1,4	4,7	10,3
FBRP85A048	4,8	3/16	0,181	2,2	200	656	45	1,8	6,7	14,8
FBRP85A050	5,0	1/5	0,197	2,4	100	328	50	2	7,1	15,7
FBRP85A060	6,0	7/32	0,283	3,4	100	328	60	2,4	10,4	22,9
FBRP85A063	6,3	1/4	0,310	3,8	100	328	65	2,6	11,4	25,1
FBRP85A070	7,0	9/32	0,385	4,7	100	328	70	2,8	14,1	31,0
FBRP85A080	8,0	5/16	0,500	6,0	100	328	80	3,2	18,4	40,4
FBRP85A095	9,5	3/8	0,710	8,5	100	328	95	3,8	25,9	57,0
FBRP85A100	10,0	7/16	0,785	9,4	50	164	100	4	28,6	62,8
FBRP85A120	12,0	15/32	1,130	13,5	50	164	120	4,8	40,8	89,8
FBRP85A125	12,5	1/2	1,230	14,8	50	164	125	5	44,9	98,7
FBRP85A15	15,0	19/32	1,770	21,5	50	164	150	6	64,9	142,7
FBRP85A18	18,0	3/4	2,54	31,0	50	164	180	7,2	92,8	204,2
FBRP85A20	20,0	25/32	3,14	40,0	50	164	200	7,9	115,3	253,6

approx. 88° Shore A

Recommended pretension 4...8 %

Coeff. of friction μ : Steel: approx. 0,60 | PE: approx. 0,35 | HDPE: approx. 0,30

*For overlap welding, the recommended minimum pulley diameter must be increased by +30%.

PU85A green rough



Order No.	Diameter \varnothing		Cross section cm ²	approx. Weight kg/100m	Standard Roll		Recommended Min. pulley \varnothing		Fmax/belt (Standard)	
	mm	inch			m	ft	mm	inch	kg	lbs
FBRP85A020R	2,0	5/64	0,032	0,5	200	656	15	0,6	1,2	2,7
FBRP85A030R	3,0	1/8	0,071	0,9	200	656	25	1	2,7	5,8
FBRP85A040R	4,0	5/32	0,126	1,6	200	656	35	1,4	4,7	10,3
FBRP85A048R	4,8	3/16	0,181	2,2	200	656	45	1,8	6,7	14,8
FBRP85A050R	5,0	1/5	0,197	2,4	100	328	50	2	7,1	15,7
FBRP85A060R	6,0	7/32	0,283	3,4	100	328	60	2,4	10,4	22,9
FBRP85A063R	6,3	1/4	0,310	3,8	100	328	65	2,6	11,4	25,1
FBRP85A070R	7,0	9/32	0,385	4,7	100	328	70	2,8	14,1	31,0
FBRP85A080R	8,0	5/16	0,500	6,0	100	328	80	3,2	18,4	40,4
FBRP85A095R	9,5	3/8	0,710	8,5	100	328	95	3,8	25,9	57,0
FBRP85A100R	10,0	7/16	0,785	9,4	50	164	100	4	28,6	62,8
FBRP85A120R	12,0	15/32	1,130	13,5	50	164	120	4,8	40,8	89,8
FBRP85A125R	12,5	1/2	1,230	14,8	50	164	125	5	44,9	98,7
FBRP85A15R	15,0	19/32	1,770	21,5	50	164	150	6	64,9	142,7
FBRP85A18R	18,0	3/4	2,54	31,0	50	164	180	7,2	92,8	204,2
FBRP85A20R	20,0	25/32	3,14	40,0	50	164	200	7,9	115,3	253,6

approx. 88° Shore A

Recommended pretension 4...8 %

Coeff. of friction μ : Steel: approx. 0,45 | PE: approx. 0,30 | HDPE: approx. 0,25

PU85A green smooth, reinforced Aramid



Order No.	Diameter \varnothing		Cross section cm ²	approx. weight kg/100m	Standard roll		Recommended Min. pulley \varnothing^*		Fmax/belt (Standard)		Fmax/belt (Overlap)	
	mm	inch			m	ft	mm	inch	kg	lbs	kg	lbs
FBZRP85A050A	5,0	1/5	0,197	2,4	100	328	50	2,0	7,1	15,7	-	-
FBZRP85A060A	6,0	7/32	0,283	3,4	100	328	60	2,3	10,4	22,9	23,0	50,5
FBZRP85A063A	6,3	1/4	0,310	3,8	100	328	65	2,5	11,4	25,1	25,2	55,4
FBZRP85A070A	7,0	9/32	0,385	4,7	100	328	70	2,8	14,1	31,0	31,1	68,3
FBZRP85A080A	8,0	5/16	0,500	6,0	100	328	80	3,2	18,4	40,4	40,5	89,1
FBZRP85A095A	9,5	3/8	0,710	8,5	100	328	95	3,7	25,9	57,0	57,2	125,7
FBZRP85A100A	10,0	7/16	0,785	9,4	50	164	100	3,9	28,6	62,8	63,0	138,6
FBZRP85A120A	12,0	15/32	1,130	13,5	50	164	120	4,7	40,8	89,8	90,0	198,0
FBZRP85A125A	12,5	1/2	1,230	14,8	50	164	125	4,9	44,9	98,7	99,0	217,8
FBZRP85A143A	14,3	9/16	1,616	19,3	50	164	145	5,7	59,0	129,7	130,1	286,1
FBZRP85A150A	15,0	19/32	1,77	21,5	50	164	150	5,9	64,9	142,7	143,1	314,8
FBZRP85A180A	18,0	3/4	2,54	31,0	50	164	190	7,5	92,8	204,2	204,8	450,5
FBZRP85A200A	20,0	25/32	3,14	40,0	50	164	200	7,9	115,3	253,6	254,3	559,4

approx. 88° Shore A

Recommended pretension
0,5...2 %

Coeff. of friction μ : Steel: approx. 0,60 | PE: approx. 0,35 | HDPE: approx. 0,30

*For overlap welding, the recommended minimum pulley diameter must be increased by +30%.

PU85A green rough, reinforced Aramid



Order No.	Diameter Ø		Cross section cm ²	approx. weight kg/100m	Standard roll		Recommended Min. pulley Ø*		Fmax/belt (Standard)		Fmax/belt (Overlap)	
	mm	inch			m	ft	mm	inch	kg	lbs	kg	lbs
FBZR85A050RA	5,0	1/5	0,197	2,4	100	328	50	2,0	7,1	15,7	-	-
FBZR85A060RA	6,0	7/32	0,283	3,4	100	328	60	2,3	10,4	22,9	23,0	50,5
FBZR85A063RA	6,3	1/4	0,310	3,8	100	328	65	2,5	11,4	25,1	25,2	55,4
FBZR85A070RA	7,0	9/32	0,385	4,7	100	328	70	2,8	14,1	31,0	31,1	68,3
FBZR85A080RA	8,0	5/16	0,500	6,0	100	328	80	3,2	18,4	40,4	40,5	89,1
FBZR85A095RA	9,5	3/8	0,710	8,5	100	328	95	3,7	25,9	57,0	57,2	125,7
FBZR85A100RA	10,0	7/16	0,785	9,4	50	164	100	3,9	28,6	62,8	63,0	138,6
FBZR85A120RA	12,0	15/32	1,130	13,5	50	164	120	4,7	40,8	89,8	90,0	198,0
FBZR85A127RA	12,5	1/2	1,230	14,8	50	164	125	4,9	44,9	98,7	99,0	217,8
FBZR85A143RA	14,3	9/16	1,616	19,3	50	164	145	5,7	59,0	129,7	130,1	286,1
FBZR85A150RA	15,0	19/32	1,77	21,5	50	164	150	5,9	64,9	142,7	143,1	314,8
FBZR85A180RA	18,0	3/4	2,54	31,0	50	164	190	7,5	92,8	204,2	204,8	450,5
FBZR85A200RA	20,0	25/32	3,14	40,0	50	164	200	7,9	115,3	253,6	254,3	559,4

approx. 88° Shore A

Recommended pretension
0,5...2 %

Coeff. of friction μ: Steel: approx. 0,45 | PE: approx. 0,30 | HDPE: approx. 0,25

PU85A ultramarine blue rough



FDA
EC

Order No.	Diameter Ø		Cross section cm ²	approx. Weight kg/100m	Standard Roll		Recommended Min. pulley Ø		Fmax/belt (Standard)	
	mm	inch			m	ft	mm	inch	kg	lbs
FBRK020LRB	2,0	5/64	0,032	0,5	200	656	15	0,6	1,2	2,7
FBRK030LRB	3,0	1/8	0,071	0,9	200	656	25	1	2,7	5,8
FBRK040LRB	4,0	5/32	0,126	1,6	200	656	35	1,4	4,7	10,3
FBRK048LRB	4,8	3/16	0,181	2,2	200	656	45	1,8	6,7	14,8
FBRK050LRB	5,0	1/5	0,197	2,4	100	328	50	2	7,1	15,7
FBRK060LRB	6,0	7/32	0,283	3,4	100	328	60	2,4	10,4	22,9
FBRK063LRB	6,3	1/4	0,310	3,8	100	328	65	2,6	11,4	25,1
FBRK070LRB	7,0	9/32	0,385	4,7	100	328	70	2,8	14,1	31,0
FBRK080LRB	8,0	5/16	0,500	6,0	100	328	80	3,2	18,4	40,4
FBRK095LRB	9,5	3/8	0,710	8,5	100	328	95	3,8	25,9	57,0
FBRK100LRB	10,0	7/16	0,785	9,4	50	164	100	4	28,6	62,8
FBRK120LRB	12,0	15/32	1,130	13,5	50	164	120	4,8	40,8	89,8
FBRK125LRB	12,5	1/2	1,230	14,8	50	164	125	5	44,9	98,7
FBRK150LRB	15,0	19/32	1,770	21,5	50	164	150	6	64,9	142,7

approx. 88° Shore A

Recommended pretension 4...8 %

Coeff. of friction μ: Steel: approx. 0,45 | PE: approx. 0,30 | HDPE: approx. 0,25 | FDA/EC compliant

*For overlap welding, the recommended minimum pulley diameter must be increased by +30%.

PU85A ultramarine blue rough, reinforced Aramid



Order No.	Diameter Ø		Cross section cm ²	approx. weight kg/100m	Standard roll		Recommended Min. pulley Ø*		Fmax/belt (Standard)		Fmax/belt (Overlap)	
	mm	inch			m	ft	mm	inch	kg	lbs	kg	lbs
FBRK050LRC	5,0	1/5	0,197	2,4	100	328	50	2,0	7,1	15,7	-	-
FBRK060LRC	6,0	7/32	0,283	3,4	100	328	60	2,3	10,4	22,9	23,0	50,5
FBRK063LRC	6,3	1/4	0,310	3,8	100	328	65	2,5	11,4	25,1	25,2	55,4
FBRK070LRC	7,0	9/32	0,385	4,7	100	328	70	2,8	14,1	31,0	31,1	68,3
FBRK080LRC	8,0	5/16	0,500	6,0	100	328	80	3,2	18,4	40,4	40,5	89,1
FBRK095LRC	9,5	3/8	0,710	8,5	100	328	95	3,7	25,9	57,0	57,2	125,7
FBRK100LRC	10,0	7/16	0,785	9,4	50	164	100	3,9	28,6	62,8	63,0	138,6
FBRK120LRC	12,0	15/32	1,130	13,5	50	164	120	4,7	40,8	89,8	90,0	198,0
FBRK125LRC	12,5	1/2	1,230	14,8	50	164	125	4,9	44,9	98,7	99,0	217,8
FBRK150LRC	15,0	19/32	1,77	21,5	50	164	150	5,9	64,9	142,7	143,1	314,8

approx. 88° Shore A

Recommended pretension

0,5...2 %

Coeff. of friction μ : Steel: approx. 0,45 | PE: approx. 0,30 | HDPE: approx. 0,25 | FDA/EC compliant

PU85A sapphire blue smooth

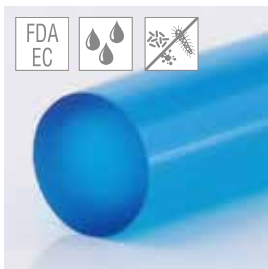

Order No.	Diameter Ø		Cross section cm ²	approx. Weight kg/100m	Standard Roll		Recommended Min. pulley Ø		Fmax/belt (Standard)	
	mm	inch			m	ft	mm	inch	kg	lbs
FBRK020LGAAA	2,0	5/64	0,032	0,5	200	656	15	0,6	1,0	2,2
FBRK030LGAAA	3,0	1/8	0,071	0,9	200	656	25	1	2,4	5,3
FBRK040LGAAA	4,0	5/32	0,126	1,6	200	656	35	1,4	4,2	9,3
FBRK048LGAAA	4,8	3/16	0,181	2,2	200	656	45	1,8	6,3	13,8
FBRK050LGAAA	5,0	1/5	0,197	2,4	100	328	50	2	6,7	14,7
FBRK060LGAAA	6,0	7/32	0,283	3,4	100	328	60	2,4	9,7	21,3
FBRK063LGAAA	6,3	1/4	0,310	3,8	100	328	65	2,6	10,7	23,6
FBRK070LGAAA	7,0	9/32	0,385	4,7	100	328	70	2,8	13,1	28,9
FBRK080LGAAA	8,0	5/16	0,500	6,0	100	328	80	3,2	17,2	37,8
FBRK095LGAAA	9,5	3/8	0,710	8,5	100	328	95	3,8	24,4	53,8
FBRK100LGAAA	10,0	7/16	0,785	9,4	50	164	100	4	26,9	59,1
FBRK120LGAAA	12,0	15/32	1,130	13,5	50	164	120	4,8	38,8	85,3
FBRK125LGAAA	12,5	1/2	1,230	14,8	50	164	125	5	42,2	92,9
FBRK150LGAAA	15,0	19/32	1,770	21,5	50	164	150	6	60,8	133,8

approx. 88° Shore A

Recommended pretension 4...8 %

Coeff. of friction μ : Steel: approx. 0,60 | PE: approx. 0,35 | HDPE: approx. 0,30 | FDA/EC/USDA compliant

*For overlap welding, the recommended minimum pulley diameter must be increased by +30%.

PU85A sapphire blue smooth, reinforced Polyester

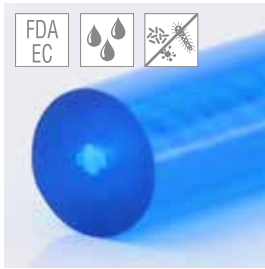

approx. 88° Shore A

Recommended pretension
0,5...2 %

Order No.	Diameter Ø		Cross section cm ²	approx. weight kg/100m	Standard roll		Recommended Min. pulley Ø*		Fmax/belt (Standard)		Fmax/belt (Overlap)	
	mm	inch			m	ft	mm	inch	kg	lbs	kg	lbs
FBRK060LGAAC	6,0	7/32	0,283	3,4	100	328	60	2,4	9,7	21,3	21,6	47,5
FBRK063LGA	6,3	1/4	0,310	3,8	100	328	65	2,6	10,7	23,6	23,9	52,5
FBRK070LGA	7,0	9/32	0,385	4,7	100	328	70	2,8	13,1	28,9	29,3	64,4
FBRK080LGA	8,0	5/16	0,500	6,0	100	328	80	3,2	17,2	37,8	38,3	84,2
FBRK095LGA	9,5	3/8	0,710	8,5	100	328	95	3,7	24,4	53,8	54,5	119,8
FBRK100LGA	10,0	7/16	0,785	9,4	50	164	100	3,9	26,9	59,1	59,9	131,7
FBRK120LGA	12,0	15/32	1,130	13,5	50	164	120	4,7	38,8	85,3	86,4	190,1
FBRK125LGA	12,5	1/2	1,230	14,8	50	164	125	4,9	42,2	92,9	94,1	206,9
FBRK150LGA	15,0	19/32	1,770	21,5	50	164	150	5,9	60,8	133,8	135,5	298,0

Coeff. of friction μ : Steel: approx. 0,60 | PE: approx. 0,35 | HDPE: approx. 0,30 | FDA/EC/USDA compliant

PU85A plus ultramarine blue rough



approx. 88° Shore A

Recommended pretension 3...6 %

Order No.	Diameter Ø		Cross section cm ²	approx. Weight kg/100m	Standard Roll		Recommended Min. pulley Ø		Fmax/belt (Standard)	
	mm	inch			m	ft	mm	inch	kg	lbs
FBRK020LR	2,0	5/64	0,032	0,5	200	656	15	0,6	1,3	2,9
FBRK030LR	3,0	1/8	0,071	0,9	200	656	25	1	3,0	6,6
FBRK040LR	4,0	5/32	0,126	1,6	200	656	35	1,4	5,3	11,6
FBRK048LR	4,8	3/16	0,181	2,2	200	656	45	1,8	7,5	16,5
FBRK050LR	5,0	1/5	0,197	2,4	100	328	50	2	8,1	17,8
FBRK060LR	6,0	7/32	0,283	3,4	100	328	60	2,4	11,7	25,6
FBRK063LR	6,3	1/4	0,310	3,8	100	328	65	2,6	12,8	28,1
FBRK070LR	7,0	9/32	0,385	4,7	100	328	70	2,8	16,0	35,2
FBRK080LR	8,0	5/16	0,500	6,0	100	328	80	3,2	20,7	45,5
FBRK095LR	9,5	3/8	0,710	8,5	100	328	95	3,8	29,3	64,5
FBRK100LR	10,0	7/16	0,785	9,4	50	164	100	4	32,5	71,6
FBRK120LR	12,0	15/32	1,130	13,5	50	164	120	4,7	46,5	102,3
FBRK125LR	12,5	1/2	1,230	14,8	50	164	125	4,9	51,2	112,6
FBRK150LR	15,0	19/32	1,770	21,5	50	164	150	5,9	74,0	162,8

Coeff. of friction μ : Steel: approx. 0,45 | PE: approx. 0,30 | HDPE: approx. 0,25

PU85A ultramarine blue smooth, reinforced glass fibre PU



approx. 88° Shore A

Recommended pretension
0,5...2 %

Order No.	Diameter Ø		Cross section cm ²	approx. Weight kg/100m	Standard Roll		Recommended Min. pulley Ø		Fmax/belt (Standard)	
	mm	inch			m	ft	mm	inch	kg	lbs
FBZRP85A080	8,0	5/16	0,500	6,0	100	328	85	3,4	19,8	43,5
FBZRP85A095	9,5	3/8	0,71	8,5	100	328	100	4,0	28,1	61,9
FBZRP85A100	10,0	7/16	0,785	9,4	50	164	105	4,2	31,0	68,2
FBZRP85A120	12,0	15/32	1,130	13,5	50	164	125	5,0	44,7	98,3
FBZRP85A125	12,5	1/2	1,23	14,8	50	164	130	5,2	48,6	107,0
FBZRP85A143	14,3	9/16	1,605	21,0	50	164	150	6,0	63,4	139,4
FBZRP85A150	15,0	19/32	1,77	21,5	50	164	155	6,2	69,9	153,8

Coeff. of friction μ : Steel: approx. 0,60 | PE: approx. 0,35 | HDPE: approx. 0,30

*For overlap welding, the recommended minimum pulley diameter must be increased by +30%.

PU85A ultramarine blue rough, reinforced glass fibre PU



Order No.	Diameter Ø		Cross section cm ²	approx. Weight kg/100m	Standard Roll		Recommended Min. pulley Ø		Fmax/belt (Standard)	
	mm	inch			m	ft	mm	inch	kg	lbs
FBZRP85A080R	8,0	5/16	0,500	6,0	100	328	85	3,2	19,8	43,5
FBZRP85A095R	9,5	3/8	0,710	8,5	100	328	100	3,7	28,1	61,9
FBZRP85A100R	10,0	7/16	0,785	9,4	50	164	105	3,9	31,0	68,2
FBZRP85A120R	12,0	15/32	1,130	13,5	50	164	125	4,7	44,7	98,3
FBZRP85A125R	12,5	1/2	1,230	14,8	50	164	130	4,9	48,6	107,0
FBZRP85A143R	14,3	9/16	1,605	21,0	50	164	150	5,7	63,4	139,4
FBZRP85A150R	15,0	19/32	1,770	21,5	50	164	155	5,9	69,9	153,8
FBZRP85A180R	18,0	3/4	2,54	31,0	50	164	195	7,5	-	-
FBZRP85A200R	20,0	25/32	3,14	40,0	50	164	205	7,9	-	-

approx. 88° Shore A

Recommended pretension
0,5...2 %

Coeff. of friction μ : Steel: approx. 0,45 | PE: approx. 0,30 | HDPE: approx. 0,25

PU85A emerald green smooth, antistatic-dissipative



Belt for electrostatic discharge.

Order No.	Diameter Ø		Cross section cm ²	approx. Weight kg/100m	Standard Roll		Recommended Min. pulley Ø		Fmax/belt (Standard)	
	mm	inch			m	ft	mm	inch	kg	lbs
FBRK020GGAAA	2,0	5/64	0,032	0,5	200	656	15	0,6	1,2	2,7
FBRK030GGAAA	3,0	1/8	0,071	0,9	200	656	25	1	2,7	5,8
FBRK040GGAAA	4,0	5/32	0,126	1,6	200	656	35	1,4	4,7	10,3
FBRK048GGAAA	4,8	3/16	0,181	2,2	200	656	45	1,8	6,7	14,8
FBRK050GGAAA	5,0	1/5	0,197	2,4	100	328	50	2	7,1	15,7
FBRK060GGAAA	6,0	7/32	0,283	3,4	100	328	60	2,4	10,4	22,9
FBRK063GGAAA	6,3	1/4	0,310	3,8	100	328	65	2,6	11,4	25,1
FBRK070GGAAA	7,0	9/32	0,385	4,7	100	328	70	2,8	14,1	31,0
FBRK080GGAAA	8,0	5/16	0,500	6,0	100	328	80	3,2	18,4	40,4
FBRK095GGAAA	9,5	3/8	0,710	8,5	100	328	95	3,8	25,9	57,0
FBRK100GGAAA	10,0	7/16	0,785	9,4	50	164	100	4	28,6	62,8
FBRK120GGAAA	12,0	15/32	1,130	13,5	50	164	120	4,8	40,8	89,8
FBRK125GGAAA	12,5	1/2	1,230	14,8	50	164	125	5	44,9	98,7
FBRK150GGAAA	15,0	19/32	1,770	21,5	50	164	150	6	64,9	142,7

approx. 88° Shore A

Recommended pretension 4...8 %

$R_g = <10^9 \Omega (1 G\Omega)$

Surface resistance to ground according to IEC61340-2-3/EN61340-5-1

Coeff. of friction μ : Steel: approx. 0,60 | PE: approx. 0,35 | HDPE: approx. 0,30

PU85A black smooth, antistatic conductive



Order No.	Diameter Ø		Cross section cm ²	approx. Weight kg/100m	Standard Roll		Recommended Min. pulley Ø		Fmax/belt (Standard)	
	mm	inch			m	ft	mm	inch	kg	lbs
FBRK030SGA	3,0	1/8	0,071	0,9	200	656	30	1,2	2,3	5,1
FBRK040SGA	4,0	5/32	0,126	1,6	200	656	40	1,6	4,1	9,2
FBRK050SGA	5,0	1/5	0,197	2,4	100	328	50	2,0	6,2	13,6
FBRK060SGA	6,0	7/32	0,283	3,4	100	328	60	2,4	9,1	20,0

approx. 88° Shore A

Recommended pretension 3...6 %

Coeff. of friction μ : Steel: approx. 0,60 | PE: approx. 0,35 | HDPE: approx. 0,30

Belt for electrostatic discharge, $R_g = 10^6 \Omega (1 M\Omega)$, Surface resistance to ground according to IEC61340-2-3/EN61340-5-1

PU90A white smooth



● red upon request

Order No.	Diameter Ø		Cross section cm ²	approx. Weight kg/100 m	Standard Roll		Recommended Min. pulley Ø		Fmax/belt (Standard)	
	mm	inch			m	ft	mm	inch	kg	lbs
FBRP90A020	2,0	5/64	0,032	0,5	200	656	20	0,8	1,9	4,1
FBRP90A030	3,0	1/8	0,071	0,9	200	656	30	1,2	3,4	7,4
FBRP90A040	4,0	5/32	0,126	1,6	200	656	40	1,6	5,9	12,9
FBRP90A048	4,8	3/16	0,181	2,2	200	656	50	2	8,5	18,7
FBRP90A050	5,0	1/5	0,197	2,4	100	328	55	2,2	9,3	20,4
FBRP90A060	6,0	7/32	0,283	3,4	100	328	70	2,8	13,3	29,2
FBRP90A063	6,3	1/4	0,310	3,8	100	328	75	3	14,6	32,2
FBRP90A070	7,0	9/32	0,385	4,7	100	328	85	3,3	18,3	40,2
FBRP90A080	8,0	5/16	0,500	6,0	100	328	90	3,6	23,8	52,3
FBRP90A095	9,5	3/8	0,710	8,5	100	328	105	4,2	33,3	73,2
FBRP90A100	10,0	7/16	0,785	9,4	50	164	110	4,4	37,3	82,0
FBRP90A120	12,0	15/32	1,130	13,5	50	164	130	5,1	53,3	117,2
FBRP90A125	12,5	1/2	1,23	14,8	50	164	135	5,3	58,0	127,6
FBRP90A15	15,0	19/32	1,770	21,5	50	164	165	6,5	83,6	184,0
FBRP90A18	18,0	3/4	2,54	31,0	50	164	200	7,9	119,8	263,5
FBRP90A20	20,0	25/32	3,14	40,0	50	164	220	8,7	148,3	326,2

approx. 92° Shore A

Recommended pretension 3...5 %

Coeff. of friction μ

Steel	approx. 0,50
PE	approx. 0,30
HDPE	approx. 0,25

PU90A white smooth, reinforced Polyester



approx. 92° Shore A

Recommended pretension
0,5...2 %

Coeff. of friction μ

Steel	approx. 0,50
PE	approx. 0,30
HDPE	approx. 0,25

Order No.	Diameter Ø		Cross section cm ²	approx. weight kg/100 m	Standard roll		Recommended Min. pulley Ø*		Fmax/belt (Standard)		Fmax/belt (Overlap)	
	mm	inch			m	ft	mm	inch	kg	lbs	kg	lbs
FBZRP90A060P	6,0	7/32	0,283	3,4	100	328	70	2,8	13,4	29,6	22,5	49,5
FBZRP90A063P	6,3	1/4	0,310	3,8	100	328	75	3	14,8	32,5	26,3	57,8
FBZRP90A070P	7,0	9/32	0,385	4,7	100	328	85	3,3	18,4	40,6	37,5	82,5
FBZRP90A080P	8,0	5/16	0,500	6,0	100	328	90	3,6	24,0	52,8	48,8	107,3
FBZRP90A095P	9,5	3/8	0,710	8,5	100	328	105	4,2	33,6	73,9	56,3	123,8
FBZRP90A100P	10,0	7/16	0,785	9,4	50	164	110	4,4	37,6	82,8	60,0	132,0
FBZRP90A120P	12,0	15/32	1,130	13,5	50	164	130	5,1	53,8	118,3	101,3	222,8
FBZRP90A125P	12,5	1/2	1,230	14,8	50	164	135	5,3	58,6	128,8	108,8	239,3
FBZRP90A150P	15,0	19/32	1,770	21,5	50	164	165	6,5	84,5	185,9	172,5	379,5
FBZRP90A180P	18,0	3/4	2,54	31,0	50	164	200	7,9	121,0	266,1	225,0	495,0
FBZRP90A200P	20,0	25/32	3,14	40,0	50	164	220	8,7	-	-	-	-

*For overlap welding, the recommended minimum pulley diameter must be increased by +30%.

TPE40D beige smooth



FDA
EC

- TPE 40D beige smooth with reinforcement on request

Order No.	Diameter Ø		Cross section cm ²	approx. Weight kg/100m	Standard Roll		Recommended Min. pulley Ø		Fmax/belt (Standard)	
	mm	inch			m	ft	mm	inch	kg	lbs
FBRK040D020	2,0	5/64	0,032	0,5	200	656	20	0,8	1,9	4,2
FBRK040D030	3,0	1/8	0,071	0,9	200	656	30	1,2	4,1	9,1
FBRK040D040	4,0	5/32	0,126	1,6	200	656	40	1,6	7,6	16,6
FBRK040D048	4,8	3/16	0,181	2,2	200	656	50	2	10,8	23,8
FBRK040D050	5,0	1/5	0,197	2,4	100	328	55	2,2	11,7	25,7
FBRK040D060	6,0	7/32	0,283	3,4	100	328	70	2,8	17,0	37,5
FBRK040D063	6,3	1/4	0,310	3,8	100	328	75	3	18,7	41,2
FBRK040D070	7,0	9/32	0,385	4,7	100	328	85	3,3	23,0	50,7
FBRK040D080	8,0	5/16	0,500	6,0	100	328	90	3,6	30,1	66,2
FBRK040D095	9,5	3/8	0,710	8,5	100	328	105	4,2	42,8	94,2
FBRK040D100	10,0	7/16	0,785	9,4	50	164	110	4,4	47,1	103,7
FBRK040D120	12,0	15/32	1,130	13,5	50	164	130	5,1	67,9	149,5
FBRK040D125	12,5	1/2	1,230	14,8	50	164	135	5,3	74,0	162,7
FBRK040D150	15,0	19/32	1,770	21,5	50	164	165	6,5	106,5	234,2
FBRK040D180	18,0	3/4	2,54	31,0	50	164	200	7,9	151,4	333,0
FBRK040D200	20,0	25/32	3,14	40,0	50	164	220	8,7	188,2	414,0

approx. 40° Shore D / 95° Shore A

Recommended pretension 2...4 %

Coeff. of friction μ : Steel: approx. 0,50 | PE: approx. 0,30 | HDPE: approx. 0,25 | FDA/EC/USDA compliant

TPE55D beige smooth



FDA
EC

- Further colours on request

Order No.	Diameter Ø		Cross section cm ²	approx. Weight kg/100m	Standard Roll		Recommended Min. pulley Ø		Fmax/belt (Standard)	
	mm	inch			m	ft	mm	inch	kg	lbs
FBRH55D020B	2,0	5/64	0,032	0,5	200	656	30	1,2	2,4	5,3
FBRH55D030B	3,0	1/8	0,071	0,9	200	656	40	1,6	5,6	12,3
FBRH55D040B	4,0	5/32	0,126	1,6	200	656	50	2	9,9	21,8
FBRH55D048B	4,8	3/16	0,181	2,2	200	656	60	2,4	14,4	31,7
FBRH55D050B	5,0	1/5	0,197	2,4	100	328	65	2,6	15,7	34,5
FBRH55D060B	6,0	7/32	0,283	3,4	100	328	80	3,2	22,4	49,3
FBRH55D063B	6,3	1/4	0,310	3,8	100	328	85	3,3	24,8	54,6
FBRH55D070B	7,0	9/32	0,385	4,7	100	328	95	3,7	30,4	66,9
FBRH55D080B	8,0	5/16	0,500	6,0	100	328	110	4,3	40,0	88,0
FBRH55D095B	9,5	3/8	0,710	8,5	100	328	135	5,3	56,0	123,2
FBRH55D100B	10,0	7/16	0,785	9,4	50	164	145	5,7	62,9	138,3
FBRH55D120B	12,0	15/32	1,130	13,5	50	164	170	6,7	90,6	199,2
FBRH55D125B	12,5	1/2	1,230	14,8	50	164	180	7,1	97,6	214,7
FBRH55D150B	15,0	19/32	1,770	21,5	50	164	210	8,3	140,8	309,8
FBRH55D180B	18,0	3/4	2,54	31,0	50	164	250	9,8	203,2	447,0
FBRH55D200B	20,0	25/32	3,14	40,0	50	164	300	12	251,2	552,6

approx. 55° Shore D / 100° Shore A

Recommended pretension 2...4 %

Coeff. of friction μ : Steel: approx. 0,35 | PE: approx. 0,20 | HDPE: approx. 0,15 | FDA/EC/USDA compliant

TPE55D beige smooth, reinforced Polyester



FDA
EC

55° Shore D · approx. 100° Shore A

Recommended pretension 0,5...2 %

Coeff. of friction μ

Steel approx. 0,35

PE approx. 0,20

HDPE approx. 0,15

FDA/EC/USDA compliant

Order No.	Diameter \varnothing		Cross section cm ²	approx. weight kg/100m	Standard roll		Recommended Min. pulley \varnothing *		Fmax/belt (Standard)		Fmax/belt (Overlap)	
	mm	inch			m	ft	mm	inch	kg	lbs	kg	lbs
FBZRH55D060B	6,0	7/32	0,283	3,4	100	328	80	3,2	22,4	49,3	45,0	99,0
FBZRH55D063B	6,3	1/4	0,310	3,8	100	328	85	3,3	24,8	54,6	48,8	107,3
FBZRH55D070B	7,0	9/32	0,385	4,7	100	328	95	3,7	30,4	66,9	60,0	132,0
FBZRH55D080B	8,0	5/16	0,500	6,0	100	328	110	4,3	40,0	88,0	71,3	156,8
FBZRH55D095B	9,5	3/8	0,771	8,5	100	328	135	5,3	56,0	123,2	90,0	198,0
FBZRH55D100B	10,0	7/16	0,785	9,4	50	164	145	5,7	62,9	138,3	97,5	214,5
FBZRH55D120B	12,0	15/32	1,130	13,5	50	164	170	6,7	90,6	199,2	127,5	280,5
FBZRH55D125B	12,5	1/2	1,230	14,8	50	164	180	7,1	97,6	214,7	135,0	297,0
FBZRH55D150B	15,0	19/32	1,770	21,5	50	164	210	8,3	140,8	309,8	206,3	453,8
FBZRH55D180B	18,0	3/4	2,54	31,0	50	164	250	9,8	203,2	447,0	243,8	536,3
FBZRH55D200B	20,0	25/32	3,14	40,0	50	164	300	11,8	-	-	-	-



Hollow round belt with brass connector

Hollow round belts generally offer two advantages:

- The flexibility of the belts allows them to be used for small pulley diameters
- In case of belt breakage, the downtime can be bridged immediately with a nipple connection. (However, hollow round belts should always be welded.)

PU75A red smooth hollow round belt

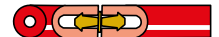

approx. 80° Shore A

Recommended pretension 4...8 %

Order No.	Diameter \varnothing		Cross section cm ²	approx. Weight kg/100m	Standard Roll		Recommended Min. pulley \varnothing		Fmax/belt (Standard)	
	Outer	Inside			m	ft	mm	inch	kg	lbs
FBHP75A048	4,8	1,8	0,147	1,8	200	656	30	1,2	3,7	8,1
FBHP75A063	6,3	2,5	0,261	3,2	100	328	45	1,8	6,7	14,7
FBHP75A080	8,0	3,2	0,420	5,1	100	328	55	2,2	10,8	23,8
FBHP75A095	9,5	3,8	0,600	7,2	100	328	65	2,6	15,3	33,7
FBHP75A125	12,5	5,2	1,020	12,4	50	164	85	3,4	26,1	57,4
FBHP75A150	15,0	5,2	1,560	19,0	50	164	100	4,0	39,6	87,1

Coeff. of friction μ : Steel: approx. 0,70 | PE: approx. 0,40 | HDPE: approx. 0,35

PU75A sky blue smooth hollow round belt



FDA
EC

-30°C

Water drop icon

Oil drop icon

approx. 80° Shore A

Recommended pretension

4...8 %

Order No.	Diameter \varnothing		Cross section cm ²	approx. Weight kg/100m	Standard Roll		Recommended Min. pulley \varnothing		Fmax/belt (Standard)	
	Outer	Inside			m	ft	mm	inch	kg	lbs
FBHP75A048HI	4,8	1,8	0,147	1,8	200	656	30	1,2	3,6	7,9
FBHP75A063HI	6,3	2,5	0,261	3,2	100	328	45	1,8	6,2	13,6
FBHP75A080HI	8,0	3,2	0,420	5,1	100	328	55	2,2	10,0	22,2
FBHP75A095HI	9,5	3,8	0,600	7,2	100	328	65	2,6	14,4	31,7
FBHP75A125HI	12,5	5,2	1,020	12,4	50	164	85	3,4	24,4	53,7
FBHP75A150HI	15,0	5,2	1,560	19,0	50	164	100	4,0	37,4	82,3

Coeff. of friction μ : Steel: approx. 0,70 | PE: approx. 0,40 | HDPE: approx. 0,35 | FDA/EC/USDA compliant

*For overlap welding, the recommended minimum pulley diameter must be increased by +30%.

PU85A yellow smooth hollow round belt



approx. 88° Shore A

Recommended pretension 4...8 %

Order No.	Diameter Ø		Cross section cm ²	approx. weight kg/100m	Standard Roll		Recommended Min.-pulley-Ø		Fmax/belt (Standard)	
	Outer	Inside			m	ft	mm	inch	kg	lbs
FBHP85A048GE	4,8	1,8	0,147	1,8	200	656	35	1,4	5,3	11,7
FBHP85A063GE	6,3	2,5	0,261	3,2	100	328	55	2,2	9,4	20,6
FBHP85A080GE	8,0	3,2	0,420	5,1	100	328	65	2,6	15,3	33,7
FBHP85A095GE	9,5	3,8	0,600	7,2	100	328	75	3,0	20,4	44,9
FBHP85A125GE	12,5	5,2	1,020	12,4	50	164	100	3,9	36,7	80,8
FBHP85A150GE	15,0	5,2	1,560	19,0	50	164	120	4,7	57,1	125,7

Coeff. of friction μ : Steel: approx. 0,60 | PE: approx. 0,35 | HDPE: approx. 0,30

PU85A green rough hollow round belt

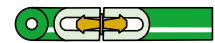

approx. 88° Shore A

Recommended pretension 4...8 %

Order No.	Diameter Ø		Cross section cm ²	approx. weight kg/100m	Standard Roll		Recommended Min.-pulley-Ø		Fmax/belt (Standard)	
	Outer	Inside			m	ft	mm	inch	kg	lbs
FBHP85A048R	4,8	1,8	0,147	1,8	200	656	35	1,4	5,3	11,7
FBHP85A063R	6,3	2,5	0,261	3,2	100	328	55	2,2	9,4	20,6
FBHP85A080R	8,0	3,2	0,420	5,1	100	328	65	2,6	15,3	33,7
FBHP85A095R	9,5	3,8	0,600	7,2	100	328	75	3,0	20,4	44,9
FBHP85A125R	12,5	5,2	1,020	12,4	50	164	100	3,9	36,7	80,8
FBHP85A150R	15,0	5,2	1,560	19,0	50	164	120	4,7	57,1	125,7

Coeff. of friction μ : Steel: approx. 0,45 | PE: approx. 0,35 | HDPE: approx. 0,30

PU85A sapphire blue smooth hollow round belt

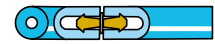

approx. 88° Shore A

Recommended pretension 4...8 %

Order No.	Diameter Ø		Cross section cm ²	approx. Weight kg/100m	Standard Roll		Recommended Min. pulley Ø		Fmax/belt (Standard)	
	Outer	Inside			m	ft	mm	inch	kg	lbs
FBHK048LG	4,8	1,8	0,147	1,8	200	656	35	1,4	5,1	11,1
FBHK063LG	6,3	2,5	0,261	3,2	100	328	55	2,2	9,0	19,8
FBHK080LG	8,0	3,2	0,420	5,1	100	328	65	2,6	14,4	31,8
FBHK095LG	9,5	3,8	0,600	7,2	100	328	75	3,0	20,6	45,3
FBHK125LG	12,5	5,2	1,020	12,4	50	164	100	3,9	35,0	77,1
FBHK150LG	15,0	5,2	1,560	19,0	50	164	120	4,7	53,5	117,8

Coeff. of friction μ : Steel: approx. 0,60 | PE: approx. 0,35 | HDPE: approx. 0,30 | FDA/EC/USDA compliant

PU90A white smooth hollow round belt



approx. 92° Shore A

Recommended pretension 3...5 %

Order No.	Diameter Ø		Cross section cm ²	approx. Weight kg/100m	Standard Roll		Recommended Min. pulley Ø		Fmax/belt (Standard)	
	Outer	Inside			m	ft	mm	inch	kg	lbs
FBHP90A048	4,8	1,8	0,147	1,8	200	656	45	1,8	8,6	19,0
FBHP90A063	6,3	2,5	0,261	3,2	100	328	60	2,4	12,4	27,2
FBHP90A080	8,0	3,2	0,420	5,1	100	328	75	3,0	19,0	41,8
FBHP90A095	9,5	3,8	0,600	7,2	100	328	85	3,4	28,5	62,7
FBHP90A125	12,5	5,2	1,020	12,4	50	164	115	4,5	47,5	104,5
FBHP90A150	15,0	5,2	1,560	19,0	50	164	140	5,5	72,3	159,0

Coeff. of friction μ : Steel: approx. 0,50 | PE: approx. 0,30 | HDPE: approx. 0,25



Can Cables

The following round belts are specially designed for the transport of empty or filled cans on short or very long conveying distances. Our professional welding technology ensures safe and durable joinings.

A special feature is the CRIMP connection for steel tension members (p. 109).

PU95A red smooth, reinforced Aramid



Order No.	Diameter Ø		Cross section cm ²	approx. weight kg/100m	Standard roll		Recommended Min. pulley Ø*		Fmax/belt (Standard)		Fmax/belt (Overlap)	
	mm	inch			m	ft	mm	inch	kg	lbs	kg	lbs
FBRN095RM	9,5	3/8	0,71	8,5	152	500	175	6,9	35,5	78,1	210	462
FBRN100RM	10,0	7/16	0,785	9,4	152	500	185	7,3	39,3	86,5	210	462
FBRN120RM	12,0	15/32	1,13	13,5	152	500	220	8,7	56,6	124,5	210	462
FBRN125RM	12,5	1/2	1,23	14,8	152	500	230	9,1	61,6	136	210	462

approx. 95° Shore A

Recommended pretension 0,5...2 %, **Coeff. of friction μ**: Steel: approx. 0,40 | PE: approx. 0,25 | HDPE: approx. 0,20

PU95A red slightly rough, reinforced Aramid



Order No.	Diameter Ø		Cross section cm ²	approx. weight kg/100m	Standard roll		Recommended Min. pulley Ø*		Fmax/belt (Standard)		Fmax/belt (Overlap)	
	mm	inch			m	ft	mm	inch	kg	lbs	kg	lbs
FBRN095RMA	9,5	3/8	0,71	8,5	152	500	175	6,9	35,5	78,1	210	462

approx. 95° Shore A

Recommended pretension 0,5...2 %, **Coeff. of friction μ**: Steel: approx. 0,40 | PE: approx. 0,25 | HDPE: approx. 0,20

TPE55D beige smooth, reinforced steel



Order No.	Diameter Ø		Cross section cm ²	approx. Weight kg/100m	Standard Roll		Recommended Min. pulley Ø		Fmax/Belt (CRIMP) ★	
	mm	inch			m	ft	mm	inch	kg	lbs
FBRS095BGB	9,5	3/8	0,710	8,5	500	1640	380	15,0	225,0	495,0
FBRS100BGB	10,0	7/16	0,785	9,4	500	1640	380	15,0	225,0	495,0
FBRS120BGB	12,0	15/32	1,082	13,0	500	1640	380	15,0	225,0	495,0
FBRS125BGB	12,5	1/2	1,230	14,8	500	1640	380	15,0	225,0	495,0

Recommended pretension max. 0,5 %

55° Shore D - approx. 100° Shore A

Coeff. of friction μ: Steel: approx. 0,35 | PE: approx. 0,20 | HDPE: approx. 0,15 | **FDA/EC/USDA compliant**

*Overlap +30%; ★ Crimp sleeve connection / connection set and tool on page 109.

TPE55D sky blue smooth, reinforced Aramid



Order No.	Diameter Ø		Cross section cm ²	approx. weight kg/100m	Standard roll		Recommended Min. pulley Ø*		Fmax/belt (Standard)		Fmax/belt (Overlap)	
	mm	inch			m	ft	mm	inch	kg	lbs	kg	lbs
FBRS095LGA	9,5	3/8	0,71	8,5	152	500	175	6,9	56	123,2	225	495
FBRS100LGA	10,0	7/16	0,785	9,4	152	500	185	7,3	62,9	138,3	225	495
FBRS120LGA	12,0	15/32	1,13	13,5	152	500	220	8,7	90,6	199,2	225	495
FBRS125LGA	12,5	1/2	1,23	14,8	152	500	230	9,1	97,6	214,7	225	495

Recommended pretension 0,5...2 %

55° Shore D - approx. 100° Shore A

Coeff. of friction μ : Steel: approx. 0,35 | PE: approx. 0,20 | HDPE: approx. 0,15 | FDA/EC/USDA compliant

TPE63D silver smooth, reinforced Polyester

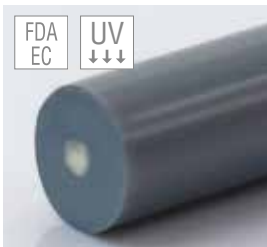

Order No.	Diameter Ø		Cross section cm ²	approx. weight kg/100m	Standard roll		Recommended Min. pulley Ø*		Fmax/belt (Standard)		Fmax/belt (Overlap)	
	mm	inch			m	ft	mm	inch	kg	lbs	kg	lbs
FBRT095IGA	9,5	3/8	0,710	8,5	152	500	190	7,5	59,4	130,6	190	418
FBRT100IGA	10,0	7/16	0,785	9,4	152	500	200	7,9	67,0	147,4	190	418
FBRT120IGA	12,0	15/32	1,130	13,5	152	500	255	10,3	96,0	211,2	190	418
FBRT125IGA	12,5	1/2	1,230	14,8	152	500	270	10,6	102,8	226,2	190	418

Recommended pretension 0,5...2 %

63° Shore D - approx. >100° Shore A

Coeff. of friction μ : Steel: approx. 0,30 | PE: approx. 0,15 | HDPE: approx. 0,10 | FDA/EC/USDA compliant

TPE63D beige smooth, reinforced Polyester



Order No.	Diameter Ø		Cross section cm ²	approx. weight kg/100m	Standard roll		Recommended Min. pulley Ø*		Fmax/belt (Standard)		Fmax/belt (Overlap)	
	mm	inch			m	ft	mm	inch	kg	lbs	kg	lbs
FBRT095NGA	9,5	3/8	0,710	8,5	152	500	190	7,5	59,4	130,6	190	418
FBRT100NGA	10,0	7/16	0,785	9,4	152	500	200	7,9	67,0	147,4	190	418
FBRT120NGA	12,0	15/32	1,130	13,5	152	500	255	10,3	96,0	211,2	190	418
FBRT125NGA	12,5	1/2	1,230	14,8	152	500	270	10,6	102,8	226,2	190	418

Recommended pretension 0,5...2 %

63° Shore D - approx. >100° Shore A

Coeff. of friction μ : Steel: approx. 0,30 | PE: approx. 0,15 | HDPE: approx. 0,10 | FDA/EC/USDA compliant

TPE63D beige smooth, reinforced Aramid



Order No.	Diameter Ø		Cross section cm ²	approx. weight kg/100m	Standard roll		Recommended Min. pulley Ø*		Fmax/belt (Standard)		Fmax/belt (Overlap)	
	mm	inch			m	ft	mm	inch	kg	lbs	kg	lbs
FBRT095NGC	9,5	3/8	0,710	8,5	152	500	190	7,5	59,4	130,6	225	495
FBRT100NGC	10,0	7/16	0,785	9,4	152	500	200	7,9	67,0	147,4	225	495
FBRT120NGC	12,0	15/32	1,130	13,5	152	500	255	10,3	96,0	211,2	225	495
FBRT125NGC	12,5	1/2	1,230	14,8	152	500	270	10,6	102,8	226,2	225	495

Recommended pretension 0,5...2 %

63° Shore D - approx. >100° Shore A

Coeff. of friction μ : Steel: approx. 0,30 | PE: approx. 0,15 | HDPE: approx. 0,10 | FDA/EC/USDA compliant



Twisted round belts / Belts with hook

Twisted round belts are the ideal solution for drive or transport systems in which several belts run on one shaft.

These belts are connected quickly, safely and easily by two hooks. The second hook is simply closed with a pair of pliers.

PU70A twisted round belts sky blue smooth



approx. 76° Shore A

Recommended pretension
8...10 %

Order No.	Diameter \varnothing		Recommended Min. pulley \varnothing		Fmax/belt (Standard)	
	mm	inch	mm	inch	kg	lbs
FBXH3X250LG FBXH3X710LG	5,0	1/5	40	1,6	2,5	5,5

Available standard lengths of 250...710 mm

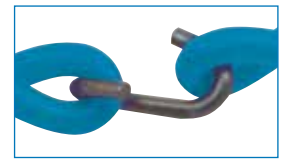

Coeff. of friction μ : Steel: approx. 0,75 | **FDA/EC/USDA compliant** (Limited suitability EC)

PU75A plus twisted round belts orange smooth (matt)



approx. 80° Shore A

Recommended pretension 6...8 %

Order No.	Diameter \varnothing		Recommended Min. pulley \varnothing		Fmax/belt (Standard)	
	mm	inch	mm	inch	kg	lbs
FBXI3X2500G FBXI3X4500G	5,0	1/5	40	1,6	3,8	8,4

Available standard lengths of 250...710 mm



Coeff. of friction μ : Steel: approx. 0,70



Measure the correct belt length tip to tip (production length Lf), without the hook.

Construction: 2 x \varnothing 3 mm (\varnothing 5 mm)



Customized belts with hook

On request, we are happy to manufacture twisted round belts in other colours or surface structures.

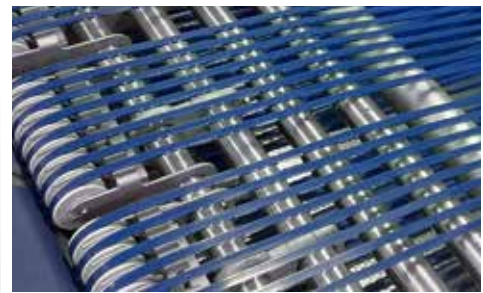

V-belts

Weldable V-belts made of PU and TPE are available in various Shore hardnesses and diameters for conveying and power-transmission applications. Many belts are food-approved and have various special properties for particularly demanding applications.

Typical industries are: Food, logistics, printing & paper, packaging, building materials and much more.

PU75A red smooth

notched version possible



Order No.	Profile dimension mm	Cross section cm ²	approx. weight kg/100 m	Standard Roll		Recommended Min. pulley Ø		Fmax/belt (Standard)	
				m	ft	mm	inch	kg	lbs
FBKP75A06	6 x 4 (Y)	0,19	2,3	100	328	35	1,4	4,9	10,8
FBKP75A08	8 x 5 (M)	0,32	4,0	100	328	40	1,6	8,2	18,1
FBKP75A10	10 x 6 (Z)	0,48	6,0	50	164	50	2,0	12,2	26,7
FBKP75A13	13 x 8 (A)	0,82	10,0	50	164	75	3,0	20,6	45,3
FBKP75A17	17 x 11 (B)	1,46	18,0	50	164	100	3,9	37,2	81,9
FBKP75A22	22 x 14 (C)	2,40	29,0	50	164	145	5,7	60,8	133,7
FBKP75A32	32 x 20 (D)	5,00	62,0	25	82	210	8,3	127,4	280,3

approx. 80° Shore A

Recommended pretension 4...8 %

Coeff. of friction μ : Steel: approx. 0,70 | PE: approx. 0,40 | HDPE: approx. 0,35

PU75A sky blue smooth

notched version possible

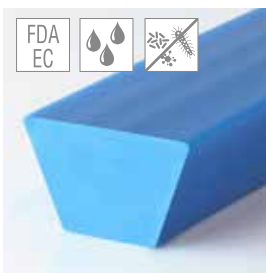

Order No.	Profile dimension mm	Cross section cm ²	approx. Weight kg/100 m	Standard Roll		Recommended Min. pulley Ø		Fmax/belt (Standard)	
				m	ft	mm	inch	kg	lbs
FBKI6YLGA	6 x 4 (Y)	0,19	2,3	100	328	35	1,4	4,6	10,1
FBKI8MLGA	8 x 5 (M)	0,32	4,0	100	328	40	1,6	7,6	15,8
FBKI10ZLGA	10 x 6 (Z)	0,48	6,0	50	164	50	2,0	11,6	25,5
FBKI13ALGA	13 x 8 (A)	0,82	10,0	50	164	75	3,0	19,6	43,1
FBKI17BLGA	17 x 11 (B)	1,46	18,0	50	164	100	3,9	35,0	77,0

approx. 80° Shore A

Recommended pretension 4...8 %

Coeff. of friction μ : Steel: approx. 0,70 | PE: approx. 0,40 | HDPE: approx. 0,35 | FDA/EC/USDA compliant

PU75A light grey, reinforced Polyester

notched version possible 



Order No.	Profile dimension	Cross section cm ²	approx. weight kg/100m	Standard Roll		Recommended Min. pulley Ø		Fmax/belt (Standard)		Fmax/belt (Overlap)	
	mm			m	ft	mm	inch	kg	lbs	kg	lbs
FBKI13AHGA	13 x 8 (A)	0,82	10,0	50	164	75	3,0	20,6	45,3	41,2	90,4
FBKI17BHGA	17 x 11 (B)	1,46	18,0	50	164	100	3,9	37,2	81,9	83,8	184,4
FBKI22CHGA	22 x 14 (C)	2,40	29,0	50	164	140	5,5	60,8	133,7	127,5	280,5

approx. 80° Shore A

Recommended pretension 0,5...2 %, **Coeff. of friction μ** : Steel: approx. 0,70 | PE: approx. 0,40 | HDPE: approx. 0,35

PU75A orange, reinforced glass fibre PU

notched version possible 



Order No.	Profile dimension	Cross section cm ²	approx. weight kg/100m	Standard Roll		Recommended Min. pulley Ø		Fmax/belt (Standard)	
	mm			m	ft	mm	inch	kg	lbs
FBZKP75A13GL	13 x 8 (A)	0,82	10,0	50	164	110	4,4	25,3	55,6
FBZKP75A17GL	17 x 11 (B)	1,46	18,0	50	164	140	5,5	45,0	98,9
FBZKP75A22GL	22 x 14 (C)	2,40	29,0	50	164	180	7,1	66,2	145,7

approx. 80° Shore A

Recommended pretension 0,5...2 %, **Coeff. of friction μ** : Steel: approx. 0,70 | PE: approx. 0,40 | HDPE: approx. 0,35

PU80A orange smooth

notched version possible 



Order No.	Profile dimension	Cross section cm ²	approx. weight kg/100m	Standard Roll		Recommended Min. pulley Ø		Fmax/belt (Standard)	
	mm			m	ft	mm	inch	kg	lbs
FBJ6YOG	6 x 4 (Y)	0,19	2,3	30	100	40	1,6	6,2	13,7
FBJ8MOG	8 x 5 (M)	0,32	4,0	30	100	45	1,8	10,3	22,6
FBJ10ZOG	10 x 6 (Z)	0,48	6,0	30	100	55	2,2	15,4	33,9
FBJ13AOG	13 x 8 (A)	0,82	10,0	30	100	85	3,3	26,3	57,9
FBJ17BOG	17 x 11 (B)	1,46	18,0	30	100	110	4,3	46,9	103,1
FBJ22COG	22 x 14 (C)	2,40	29,0	30	100	150	5,9	77,0	169,5
FBJ32DOG	32 x 20 (D)	5,00	62,0	30	100	220	8,7	160,5	353,1

approx. 84° Shore A

Recommended pretension 4...8 %, **Coeff. of friction μ** : Steel: approx. 0,65 | PE: approx. 0,35 | HDPE: approx. 0,30

FDA/EC/USDA compliant

PU80A orange smooth, reinforced Polyester

notched version possible 



Order No.	Profile dimension	Cross section cm ²	approx. weight kg/100m	Standard roll		Recommended Min. pulley Ø		Fmax/belt (Standard)		Fmax/belt (Overlap)	
	mm			m	ft	mm	inch	kg	lbs	kg	lbs
FBJ8MOGA	8 x 5 (M)	0,32	4,0	30	100	50	2,0	10,3	22,6	21,6	47,5
FBJ10ZOGA	10 x 6 (Z)	0,48	6,0	30	100	60	2,4	15,4	33,9	32,4	71,3
FBJ13AOGA	13 x 8 (A)	0,82	10,0	30	100	85	3,3	25,9	57,0	54,5	119,8
FBJ13AOGA001	13 x 8 (A)	0,82	10,0	50	164	85	3,3	25,9	57,0	54,5	119,8
FBJ17BOGA	17 x 11 (B)	1,46	18,0	30	100	110	4,3	46,9	103,1	98,6	216,8
FBJ17BOGC	17 x 11 (B)	1,46	18,0	100	328	110	4,3	46,9	103,1	98,6	216,8
FBJ22COGA	22 x 14 (C)	2,40	29,0	30	100	150	5,9	77,0	169,5	150,0	330,0
FBJ32DOGA	32 x 20 (D)	5,0	62,0	30	100	220	8,7	154	338,8	n/a	n/a

approx. 84° Shore A

Recommended pretension 0,5...2 %

Coeff. of friction μ : Steel: approx. 0,65 | PE: approx. 0,35 | HDPE: approx. 0,30 | FDA/EC/USDA compliant

PU80A transparent smooth

notched version possible

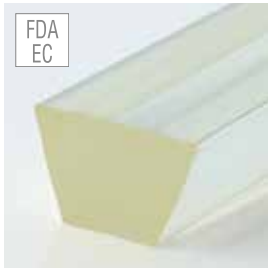

FDA
EC

Order No.	Profile dimension mm	Cross section cm ²	approx. weight kg/100m	Standard Roll		Recommended Min. pulley Ø		Fmax/belt (Standard)	
				m	ft	mm	inch	kg	lbs
FBKP80A06TR	6 x 4 (Y)	0,19	2,3	100	328	40	1,6	6,2	13,7
FBKP80A08TR	8 x 5 (M)	0,32	4,0	100	328	45	1,8	10,3	22,6
FBKP80A10TR	10 x 6 (Z)	0,48	6,0	50	164	55	2,2	15,4	33,9
FBKP80A13TR	13 x 8 (A)	0,82	10,0	50	164	85	3,3	26,3	57,9
FBKP80A17TR	17 x 11 (B)	1,46	18,0	50	164	110	4,3	46,9	103,1
FBKP80A22TR	22 x 14 (C)	2,40	29,0	50	164	150	5,9	77,0	169,5
FBKP80A32TR	32 x 20 (D)	5,00	62,0	25	82	220	8,7	160,5	353,1

approx. 84° Shore A

Recommended pretension 4...8 %

Coeff. of friction μ : Steel: approx. 0,65 | PE: approx. 0,35 | HDPE: approx. 0,30 | FDA/EC/USDA compliant

PU80A ultramarine blue smooth

notched version possible

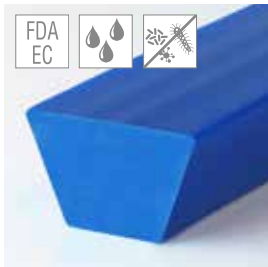

FDA
EC

Order No.	Profile dimension mm	Cross section cm ²	approx. weight kg/100m	Standard Roll		Recommended Min. pulley Ø		Fmax/belt (Standard)	
				m	ft	mm	inch	kg	lbs
FBKJ06YZLG	6 x 4 (Y)	0,19	2,3	100	328	40	1,6	6,2	13,7
FBKJ08MLG	8 x 5 (M)	0,32	4,0	100	328	45	1,8	10,3	22,6
FBKJ10ZLG	10 x 6 (Z)	0,48	6,0	50	164	55	2,2	15,4	33,9

approx. 84° Shore A

Recommended pretension 4...8 %

Coeff. of friction μ : Steel: approx. 0,65 | PE: approx. 0,35 | HDPE: approx. 0,30 | FDA/EC/USDA compliant

PU80A safe capri blue smooth

notched version possible

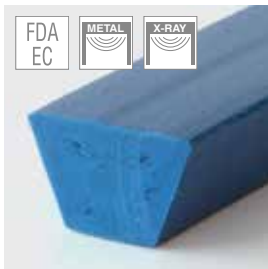

FDA
EC

Order No.	Profile dimension mm	Cross section cm ²	approx. weight kg/100m	Standard Roll		Recommended Min. pulley Ø		Fmax/belt (Standard)	
				m	ft	mm	inch	kg	lbs
FBKJ6YLGM	6 x 4 (Y)	0,19	2,3	100	328	40	1,6	4,6	10,2
FBKJ8MLGM	8 x 5 (M)	0,32	4,0	100	328	45	1,8	7,7	16,9
FBKJ10ZLGM	10 x 6 (Z)	0,48	6,0	50	164	55	2,2	11,5	25,3
FBKJ13ALGM	13 x 8 (A)	0,82	10,0	50	164	85	3,3	19,7	43,3
FBKJ17BLGM	17 x 11 (B)	1,46	18,0	50	164	110	4,3	35,0	77,1
FBKJ22CLGM	22 x 14 (C)	2,40	29,0	50	164	150	6,0	57,6	126,7

approx. 84° Shore A

Recommended pretension 3...6 %

Coeff. of friction μ : Steel: approx. 0,65 | PE: approx. 0,35 | HDPE: approx. 0,30 | FDA/EC/USDA compliant

PU85A sapphire blue smooth

notched version possible

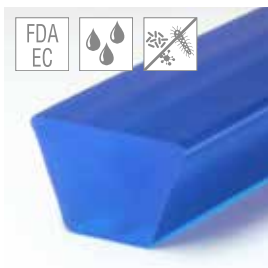

FDA
EC

Order No.	Profile dimension mm	Cross section cm ²	approx. weight kg/100m	Standard Roll		Recommended Min. pulley Ø		Fmax/belt (Standard)	
				m	ft	mm	inch	kg	lbs
FBKK06MLGAAA	6 x 4 (Y)	0,19	2,3	100	328	45	1,8	6,5	14,2
FBKK08MLGAAA	8 x 5 (M)	0,32	4,0	100	328	50	2,0	10,9	24,0
FBKK10ZLGAAA	10 x 6 (Z)	0,48	6,0	50	164	65	2,6	16,6	36,4
FBKK13ALGAAA	13 x 8 (A)	0,82	10,0	50	164	95	3,8	28,1	61,8
FBKK17BLGAAA	17 x 11 (B)	1,46	18,0	50	164	120	4,7	50,1	110,2
FBKK22CLGAAA	22 x 14 (C)	2,40	29,0	50	164	165	6,5	82,4	181,3

approx. 88° Shore A

Recommended pretension 4...8 %

Coeff. of friction μ : Steel: approx. 0,60 | PE: approx. 0,35 | HDPE: approx. 0,30 | FDA/EC/USDA compliant

PU85A sapphire blue smooth, reinforced Polyester

notched
version possible

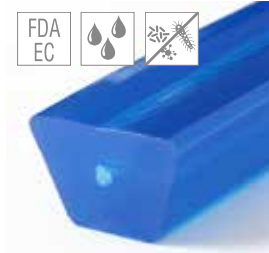

approx. 88° Shore A

Recommended pretension 0,5...2 %

Order No.	Profile dimension mm	Cross section cm ²	approx. Weight kg/100m	Standard Roll		Recommended Min. pulley ∅		Fmax/belt (Standard)		Fmax/belt (Overlap)	
				m	ft	mm	inch	kg	lbs	kg	lbs
FBZKP85A13PS	13 x 8 (A)	0,82	10,0	50	164	95	3,8	28,1	61,8	60,1	132,2
FBZKP85A17PS	17 x 11 (B)	1,46	18,0	50	164	120	4,7	50,1	110,2	105,3	231,7
FBZKP85A22PS	22 x 14 (C)	2,40	29,0	50	164	165	6,5	82,4	181,3	175,1	385,2

Coeff. of friction μ : Steel: approx. 0,60 | PE: approx. 0,35 | HDPE: approx. 0,30 | FDA/EC/USDA compliant

PU85A green smooth

notched version possible

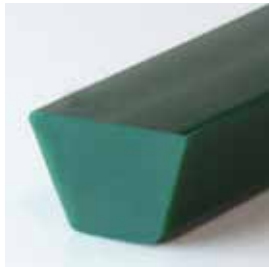

approx. 88° Shore A

Recommended pretension 4...8 %

Order No.	Profile dimension mm	Cross section cm ²	approx. weight kg/100m	Standard Roll		Recommended Min. pulley ∅		Fmax/belt (Standard)	
				m	ft	mm	inch	kg	lbs
FBKP85A06	6 x 4 (Y)	0,19	2,3	100	328	45	1,8	6,9	15,3
FBKP85A08	8 x 5 (M)	0,32	4,0	100	328	50	2,0	11,6	25,6
FBKP85A10	10 x 6 (Z)	0,48	6,0	50	164	65	2,6	17,5	38,6
FBKP85A13	13 x 8 (A)	0,82	10,0	50	164	95	3,8	30,0	66,0
FBKP85A17	17 x 11 (B)	1,46	18,0	50	164	120	4,7	53,0	116,7
FBKP85A22	22 x 14 (C)	2,40	29,0	50	164	165	6,5	87,7	193,0
FBKP85A32	32 x 20 (D)	5,00	62,0	25	82	250	9,8	195,8	430,8

Coeff. of friction μ : Steel: approx. 0,60 | PE: approx. 0,35 | HDPE: approx. 0,30

PU85A green, reinforced Aramid

notched version possible



approx. 88° Shore A

Recommended pretension
0,5...2 %

Order No.	Profile dimension mm	Cross section cm ²	approx. weight kg/100m	Standard roll		Recommended Min. pulley ∅		Fmax/belt (Standard)		Fmax/belt (Overlap)	
				m	ft	mm	inch	kg	lbs	kg	lbs
FBZKP85A08A	8 x 5 (M)	0,32	4,0	100	328	60	2,4	11,6	25,6	25,7	56,4
FBZKP85A10A	10 x 6 (Z)	0,48	6,0	50	164	70	2,8	17,5	38,6	37,5	82,5
FBZKP85A13A	13 x 8 (A)	0,82	10,0	50	164	100	3,9	30,0	66,0	63,8	140,3
FBZKP85A17A	17 x 11 (B)	1,46	18,0	50	164	140	5,5	53,0	116,7	112,5	247,5
FBZKP85A22A	22 x 14 (C)	2,40	29,0	50	164	180	7,1	87,7	193,0	187,5	412,5
FBKK32DGGA	32 x 20 (D)	5,00	62,0	40	131	275	10,8	193,8	430,8	n/a	n/a

Coeff. of friction μ : Steel: approx. 0,60 | PE: approx. 0,35 | HDPE: approx. 0,30

PU85A plus blue matt

notched version possible



approx. 88° Shore A

Recommended pretension 3...6 %

Order No.	Profile dimension mm	Cross section cm ²	approx. weight kg/100m	Standard Roll		Recommended Min. pulley ∅		Fmax/belt (Standard)	
				m	ft	mm	inch	kg	lbs
FBKP85A06BP	6 x 4 (Y)	0,19	2,3	100	328	45	1,8	7,9	17,4
FBKP85A08BP	8 x 5 (M)	0,32	4,0	100	328	50	2,0	13,2	29,0
FBKP85A10BP	10 x 6 (Z)	0,48	6,0	50	164	65	2,6	19,9	43,8
FBKP85A13BP	13 x 8 (A)	0,82	10,0	50	164	95	3,8	33,8	74,4
FBKP85A17BP	17 x 11 (B)	1,46	18,0	50	164	120	4,7	60,3	132,8
FBKP85A22BP	22 x 14 (C)	2,40	29,0	50	164	165	6,5	99,3	218,4
FBKP85A32BP	32 x 20 (D)	5,00	62,0	25	82	250	9,8	206,8	455,0

Coeff. of friction μ : Steel: approx. 0,60 | PE: approx. 0,35 | HDPE: approx. 0,30

PU85A ultramarine blue, reinforced glass fibre PU

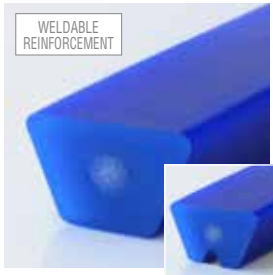

Order No.	Profile dimension mm	Cross section cm ²	approx. weight kg/100m	Standard Roll		Recommended Min. pulley Ø		Fmax/belt (Standard)	
				m	ft	mm	inch	kg	lbs
FBZKP85A13	13 x 8 (A)	0,82	10,0	50	164	125	4,9	32,8	72,2
FBZKP85A17 (Nut)	17 x 11 (B)	1,46	18,0	50	164	180	7,1	55,4	122,0
FBZKP85A22 (Nut)	22 x 14 (C)	2,40	29,0	50	164	220	8,7	92,4	203,3

approx. 88° Shore A

Recommended pretension

0,5...2 %

Coeff. of friction μ : Steel: approx. 0,60 | PE: approx. 0,35 | HDPE: approx. 0,30

PU90A white smooth

notched version possible 



Order No.	Profile dimension mm	Cross section cm ²	approx. weight kg/100m	Standard Roll		Recommended Min. pulley Ø		Fmax/belt (Standard)	
				m	ft	mm	inch	kg	lbs
FBKP90A08	8 x 5 (M)	0,32	4,0	100	328	60	2,4	15,4	33,8
FBKP90A10	10 x 6 (Z)	0,48	6,0	50	164	80	3,2	23,0	50,7
FBKP90A13	13 x 8 (A)	0,82	10,0	50	164	105	4,2	38,4	84,5
FBKP90A17	17 x 11 (B)	1,46	18,0	50	164	140	5,5	69,1	152,1
FBKP90A22	22 x 14 (C)	2,40	29,0	50	164	200	7,9	115,2	253,4
FBKP90A32 (nature)	32 x 20 (D)	5,00	62,0	25	82	320	12,6	240,0	528,0

approx. 92° Shore A

Recommended pretension 3...5 %

Coeff. of friction μ : Steel: approx. 0,50 | PE: approx. 0,30 | HDPE: approx. 0,25

PU90A white, reinforced Polyester



Order No.	Profile dimension mm	Cross section cm ²	approx. weight kg/100m	Standard roll		Recommended Min. pulley Ø		Fmax/belt (Standard)		Fmax/belt (Overlap)	
				m	ft	mm	inch	kg	lbs	kg	lbs
FBZKP90A08P	8 x 5 (M)	0,32	4,0	100	328	65	2,6	15,4	33,8	30,0	66,0
FBZKP90A10P	10 x 6 (Z)	0,48	6,0	50	164	85	3,3	23,0	50,7	45,0	99,0
FBZKP90A13P	13 x 8 (A)	0,82	10,0	50	164	110	4,3	38,4	84,5	67,5	148,5
FBZKP90A17P	17 x 11 (B)	1,46	18,0	50	164	150	5,9	69,1	152,1	120,0	264,0
FBZKP90A22P	22 x 14 (C)	2,40	29,0	50	164	210	8,3	115,2	253,4	202,5	445,5

approx. 92° Shore A

Recommended pretension

0,5...2 %

Coeff. of friction μ : Steel: approx. 0,50 | PE: approx. 0,30 | HDPE: approx. 0,25

PU90A white, reinforced Polyester, with notched bottom



Order No.	Profile dimension mm	Cross section cm ²	approx. weight kg/100m	Standard Roll		Recommended Min. pulley Ø		Fmax/belt (Standard)	
				m	ft	mm	inch	kg	lbs
FBZKP90A13PV	13 x 8 (A)	0,82	10,0	50	164	85	3,3	32,6	71,8
FBZKP90A17PV	17 x 11 (B)	1,46	18,0	50	164	110	4,3	58,8	129,3
FBZKP90A22PV	22 x 14 (C)	2,40	29,0	50	164	150	5,9	97,9	215,4

approx. 92° Shore A

Recommended pretension 0,5...2 %

Coeff. of friction μ : Steel: approx. 0,50 | PE: approx. 0,30 | HDPE: approx. 0,25

PU95A beige, reinforced Polyester

notched version possible 

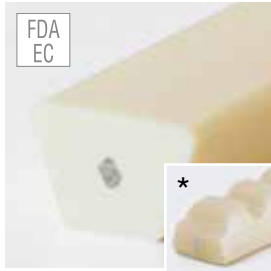

approx. 95° Shore A

Recommended pretension
0,5...2 %

Order No.	Profile dimension mm	Cross section cm ²	approx. weight kg/100 m	Standard roll		Recommended Min. pulley Ø		Fmax/belt (Standard)		Fmax/belt (Overlap)	
				m	ft	mm	inch	kg	lbs	kg	lbs
FBKM13ABGA	13 x 8 (A)	0,82	10,0	50	164	130	5,0	40,0	88,0	67,5	148,5
*FBZKP95A13PV	13 x 8 (A)	0,82	10,0	50	164	100	3,9	34,0	74,8	n/a	n/a
FBKM17BBGA	17 x 11 (B)	1,46	18,0	50	164	175	6,8	72,0	158,4	120,0	264,0
*FBZKP95A17PV	17 x 11 (B)	1,46	18,0	50	164	130	5,0	61,2	134,6	n/a	n/a
FBKM22CBGA	22 x 14 (C)	2,40	29,0	50	164	250	9,7	120,0	264,0	202,0	444,4
*FBZKP95A22PV	22 x 14 (C)	2,40	29,0	50	164	190	7,4	102,0	224,4	n/a	n/a

Coeff. of friction μ : Steel: approx. 0,45 | PE: approx. 0,25 | HDPE: approx. 0,20 | *gezahnt

TPE40D beige smooth

notched version possible 



40° Shore D - approx. 95° Shore A

Recommended pretension 2...4 %

Order No.	Profile dimension mm	Cross section cm ²	approx. weight kg/100 m	Standard Roll		Recommended Min. pulley Ø		Fmax/belt (Standard)	
				m	ft	mm	inch	kg	lbs
FBKR08MBG	8 x 5 (M)	0,32	4,0	100	328	60	2,4	19,3	42,4
FBKR10ZBG	10 x 6 (Z)	0,48	6,0	50	164	80	3,2	28,9	63,6
FBKR13ABG	13 x 8 (A)	0,82	10,0	50	164	105	4,2	49,4	108,6
FBKR17BBG	17 x 11 (B)	1,46	18,0	50	164	140	5,5	87,7	193,0
FBKR22CBG	22 x 14 (C)	2,40	29,0	50	164	200	7,9	144,5	317,9

Coeff. of friction μ : Steel: approx. 0,50 | PE: approx. 0,25 | HDPE: approx. 0,20 | FDA/EC/USDA compliant

TPE55D beige / blue smooth

notched version possible 

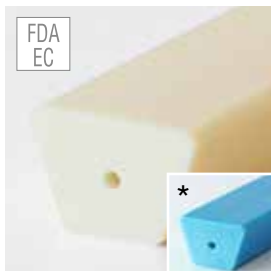

55° Shore D - approx. 100° Shore A

Recommended pretension 2...4 %

Order No.	Profile dimension mm	Cross section cm ²	approx. weight kg/100 m	Standard Roll		Recommended Min. pulley Ø		Fmax/belt (Standard)	
				m	ft	mm	inch	kg	lbs
FBKH55D08B (beige)	8 x 5 (M)	0,32	4,0	100	328	80	3,2	25,6	56,3
FBKH55D10B (beige)	10 x 6 (Z)	0,48	6,0	50	164	105	4,2	38,4	84,5
FBKH55D13B (beige)	13 x 8 (A)	0,82	10,0	50	164	130	5,1	64,0	140,8
*FBKH55D17 (blue)	17 x 11 (B)	1,46	18,0	50	164	175	7	116,8	257,0
FBKH55D22B (beige)	22 x 14 (C)	2,40	29,0	50	164	250	9,8	192,0	422,4

Coeff. of friction μ : Steel: approx. 0,35 | PE: approx. 0,20 | HDPE: approx. 0,15

FDA/EC/USDA compliant

TPE55D beige, reinforced Polyester

notched version possible 



55° Shore D - approx. 100° Shore A

Recommended pretension 0,5...2 %

Order No.	Profile dimension mm	Cross section cm ²	approx. weight kg/100 m	Standard roll		Recommended Min. pulley Ø		Fmax/belt (Standard)		Fmax/belt (Overlap)	
				m	ft	mm	inch	kg	lbs	kg	lbs
FBKH55D10P	10 x 6 (Z)	0,48	6,0	50	164	110	4,4	48	105,6	70	154
FBKH55D13P	13 x 8 (A)	0,82	10,0	50	164	135	5,3	80	176	110	242
FBKH55D17P	17 x 11 (B)	1,46	18,0	50	164	190	7,2	146	321,2	180	396
FBKH55D22P	22 x 14 (C)	2,40	29,0	50	164	260	10,2	240	528	300	660

Coeff. of friction μ : Steel: approx. 0,35 | PE: approx. 0,20 | HDPE: approx. 0,15 | FDA/EC/USDA compliant

Coatings and embossings for profiles

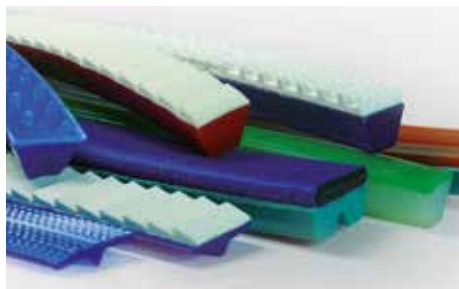

Coatings and embossings

The application of coatings to V-belts enables specific material properties, e.g. better grip, accumulation or better release on a durable base belt. The „PUtex“ coating is THE alternative to Linatex (rubber). A direct variant for optimising the conveying process is embossing the profile surfaces.

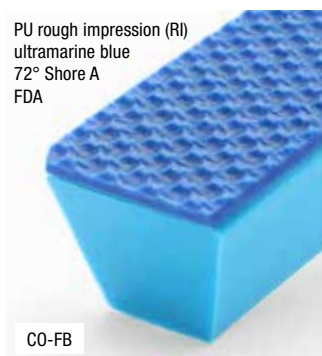

Embossings

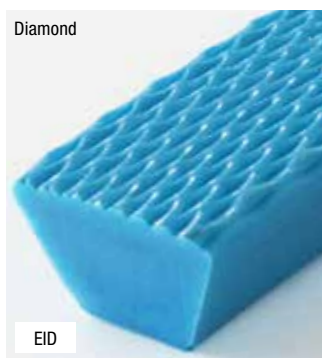



Twin-V-belts

Twin-V-belts are an optimal solution for stable conveying or spreading applications of product strands in the food industry. Our portfolio includes various design options, Shore hardness grades and reinforced products.

PU75A red smooth



approx. 80° Shore A

Recommended pretension 3...6 %

Order No.	Profile dimension mm	Cross section cm ²	approx. weight kg/100m	Standard Roll		Recommended Min. pulley Ø		Fmax/belt (Standard)	
				m	ft	mm	inch	kg	lbs
FBSP75A21X8	21 x 8	1,2	14,0	30	100	60	2,3	23,0	50,6

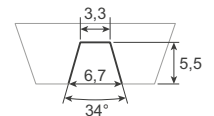

Coeff. of friction μ : Steel: approx. 0,70 | PE: approx. 0,40 | HDPE: approx. 0,35

PU75A sky blue smooth

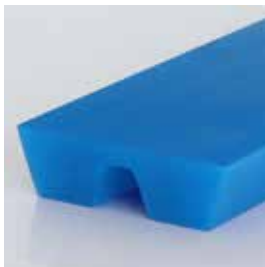

approx. 80° Shore A

Recommended pretension 3...6 %

Order No.	Profile dimension mm	Cross section cm ²	approx. weight kg/100m	Standard Roll		Recommended Min. pulley Ø		Fmax/belt (Standard)	
				m	ft	mm	inch	kg	lbs
FBSJ30X8LG	30 x 8	1,9	22,4	50	164	60	2,3	45,5	100,1

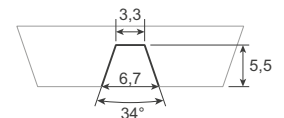

Twin A





Coeff. of friction μ : Steel: approx. 0,70 | PE: approx. 0,40 | HDPE: approx. 0,35

PU80A orange / ultramarine blue smooth



approx. 84° Shore A

Recommended pretension 3...6 %

Order No.	Color	Profile dimension mm	Cross section cm ²	approx. weight kg/100m	Standard Roll		Recommended Min. pulley Ø		Fmax/belt (Standard)	
					m	ft	mm	inch	kg	lbs
FBSJ23X68LGB		24 x 6,8	1,2	14,4	30	100	60	2,4	28,8	63,4
FBSJ24X680GB		24 x 6,8	1,2	14,4	30	100	60	2,4	28,8	63,4
FBSP80A21X8		21 x 8	1,2	14,0	30	100	80	3,1	28,8	63,4
FBSJ30X80G		30 x 8	1,9	22,4	30	100	80	3,1	45,6	100,3
FBSJ30X80GC		30 x 8	1,9	22,4	30	100	80	3,1	45,6	100,3

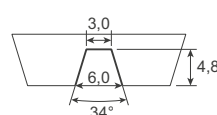

FBSJ23X68LGB
FBSJ24X680GB
(Twin Z / 3L)

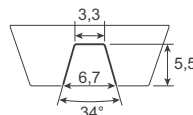

FBSP80A21X8

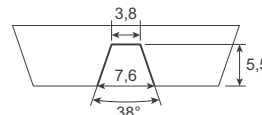

FBSJ30X80G

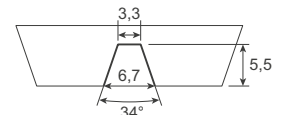

FBSJ30X80GC
(Twin A)

Coeff. of friction μ : Steel: approx. 0,65 | PE: approx. 0,35 | HDPE: approx. 0,30 | FDA/EC/USDA compliant

PU80A orange smooth, reinforced Polyester



FDA
EC

Order No.	Profile dimension mm	Cross section cm ²	approx. weight kg/100m	Standard Roll		Recommended Min. pulley Ø*		Fmax/belt (Standard)		Fmax/belt (Overlap)	
				m	ft	mm	inch	kg	lbs	kg	lbs
FBSJ21X80GA	21 x 8	1,2	14,4	30	100	80	3,1	28,8	63,4	58,4	128,5
FBSJ30X80GD	30 x 8	1,9	22,4	30	100	80	3,1	45,6	100,3	90,6	199,3

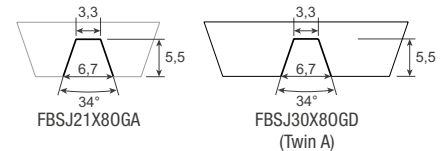

approx. 84° Shore A

Recommended pretension 0,5...2 %

Coeff. of friction μ : Steel: approx. 0,65 | PE: approx. 0,35 | HDPE: approx. 0,30 | FDA/EC/USDA compliant

PU85A mint green smooth, reinforced Polyester

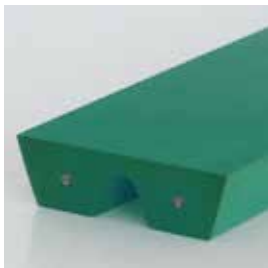

approx. 88° Shore A

Recommended pretension 0,5...2 %

Order No.	Profile dimension mm	Cross section cm ²	approx. weight kg/100m	Standard Roll		Recommended Min. pulley Ø*		Fmax/belt (Standard)		Fmax/belt (Overlap)	
				m	ft	mm	inch	kg	lbs	kg	lbs
FBSK30X8GGA	30 x 8	1,9	22,4	30	100	100	3,9	69,8	153,5	102,6	225,7

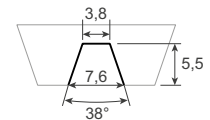

Coeff. of friction μ : Steel: approx. 0,60 | PE: approx. 0,35 | HDPE: approx. 0,30

PU95A (24 x 6,8 mm) beige 3L



FDA
EC

approx. 95° Shore A

Recommended pretension 3...5 %

Order No.	Profile dimension mm	Cross section cm ²	approx. weight kg/100m	Standard roll		Recommended Min. pulley Ø		Fmax/belt (Standard)	
				m	ft	mm	inch	kg	lbs
FBSJ24X68BGB	24 x 6,8	1,26	15	30	100	100	3,9	62,1	136,6

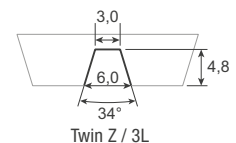

Coeff. of friction μ : Steel: approx. 0,45 | PE: approx. 0,25 | HDPE: approx. 0,20 | FDA/EC compliant

PVC Supergrip coating

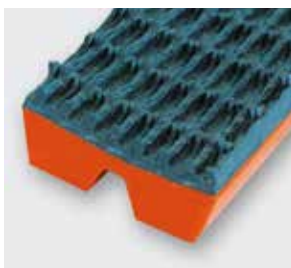

PU75A Twin-V-belt (24x6,8 mm) with PVC Supergrip coating (CO-SG).

Neoprene coating / unscrambler belt

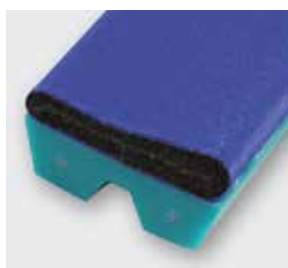

PU85A Twin-V-belt (30x8 mm) with reinforcement Polyester and neoprene coating (CO-CR). Especially for PET bottle transport / guide.

Special designs Twin-V-belt



Further versions can be found on page 50.



Rigide top V-belts for the building material and tile industry

Have a high wear resistance against heavy and abrasive building materials. Available in various Shore hardness grades for variable conveying distances. These BEHAbelt belts are made of 100% PU or TPE and are therefore easy and quick to weld.

2C, PU75A / PU80A white/transparent



Order No.	Profile dimension mm	Cross section cm ²	approx. weight kg/100m	Standard Roll		Recommended Min. pulley Ø		Fmax/belt (Standard)	
				m	ft	mm	inch	kg	lbs
FBSP85A17K2	17 x 19	2,0	24,4	30	100	160	6,4	48,0	105,6
FBSP85A22K2	22 x 25	3,5	42,3	30	100	200	8,0	84,0	184,8

approx. 80/84° Shore A

Recommended pretension: 3...6 %, **Coeff. of friction μ:** Steel: approx. 0,65 | PE: approx. 0,35 | HDPE: approx. 0,30

2C, PU75A / PU80A white/transparent, reinforced Aramid

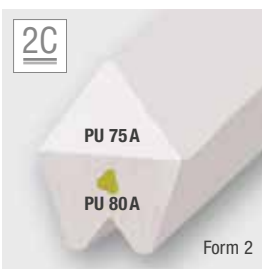

Order No.	Profile dimension mm	Cross section cm ²	approx. weight kg/100m	Standard Roll		Recommended Min. pulley Ø		Fmax/belt (Standard)	
				m	ft	mm	inch	kg	lbs
FBZSP85A17K2	17 x 19	2,0	24,4	30	100	170	6,8	48,0	105,6
FBZSP85A22K2	22 x 25	3,5	42,3	30	100	210	8,4	84,0	184,8

approx. 80/84° Shore A

Recommended pretension: 0,5...2 %, **Coeff. of friction μ:** Steel: approx. 0,65 | PE: approx. 0,35 | HDPE: approx. 0,30

PU80A transparent



Order No.	Profile dimension mm	Cross section cm ²	approx. weight kg/100m	Standard Roll		Recommended Min. pulley Ø		Fmax/belt (Standard)	
				m	ft	mm	inch	kg	lbs
FBBJ22X25TG0	22 x 25	3,65	43,8	30	100	210	8,4	87,6	192,7

approx. 84° Shore A

Recommended pretension: 3...6 %, **Coeff. of friction μ:** Steel: approx. 0,65 | PE: approx. 0,35 | HDPE: approx. 0,30

FDA/EC compliant

PU80A transparent, reinforced Polyester

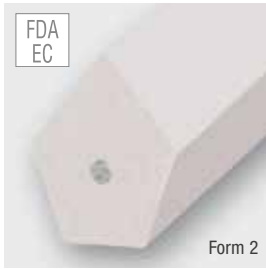

Form 2

approx. 84° Shore A

Order No.	Profile dimension	Cross section cm ²	approx. weight kg/100m	Standard Roll		Recommended Min. pulley Ø		Fmax/belt (Standard)	
	mm			m	ft	mm	inch	kg	lbs
FBBJ22X25TGA	22 x 25	3,65	43,8	30	100	210	8,4	87,6	192,7

Recommended pretension: 0,5...2 %, **Coeff. of friction μ** : Steel: approx. 0,65 | PE: approx. 0,35 | HDPE: approx. 0,30

FDA/EC compliant

PU85A green

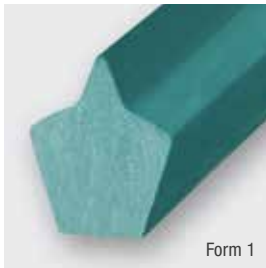

Form 1

approx. 88° Shore A

Order No.	Profile dimension	Cross section cm ²	approx. weight kg/100m	Standard Roll		Recommended Min. pulley Ø		Fmax/belt (Standard)	
	mm			m	ft	mm	inch	kg	lbs
FBSP85A170N	17 x 19	1,95	23,6	30	100	180	7,2	53,8	118,4
FBSP85A220N	22 x 25	3,26	39,1	30	100	220	8,8	90,0	198,0

Recommended pretension: 3...6 %, **Coeff. of friction μ** : Steel: approx. 0,60 | PE: approx. 0,35 | HDPE: approx. 0,30

PU85A green



Form 2

approx. 88° Shore A

Order No.	Profile dimension	Cross section cm ²	approx. weight kg/100m	Standard Roll		Recommended Min. pulley Ø		Fmax/belt (Standard)	
	mm			m	ft	mm	inch	kg	lbs
FBAK17X19GG	17 x 19	2,13	25,6	30	100	190	7,6	59,0	129,8
FBAK22X25GG	22 x 25	3,65	43,8	30	100	240	9,6	100,7	221,6

Recommended pretension: 3...6 %, **Coeff. of friction μ** : Steel: approx. 0,60 | PE: approx. 0,35 | HDPE: approx. 0,30

PU85A green, reinforced Polyester



Form 2

approx. 88° Shore A

Order No.	Profile dimension	Cross section cm ²	approx. weight kg/100m	Standard Roll		Recommended Min. pulley Ø		Fmax/belt (Standard)	
	mm			m	ft	mm	inch	kg	lbs
FBBK17X19GGA	17 x 19	2,13	25,6	30	100	190	7,6	59,0	129,8
FBBK22X25GGA	22 x 25	3,65	43,8	30	100	240	9,6	100,7	221,6

Recommended pretension: 0,5...2 %, **Coeff. of friction μ** : Steel: approx. 0,60 | PE: approx. 0,35 | HDPE: approx. 0,30

PU85A blue, reinforced glass fibre PU

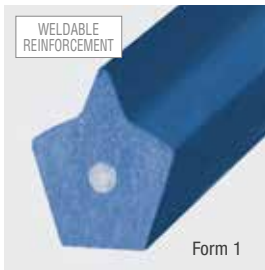

approx. 88° Shore A

Order No.	Profile dimension mm	Cross section cm ²	approx. weight kg/100m	Standard Roll		Recommended Min. pulley Ø		Fmax/belt (Standard)	
				m	ft	mm	inch	kg	lbs
FBZSP85A170N	17 x 19	1,95	23,63	30	100	240	9,6	78,0	171,6
FBZSP85A220N	22 x 25	3,26	39,1	30	100	280	11,2	130,4	286,9

Recommended pretension: 0,5...2 %, **Coeff. of friction μ** : Steel: approx. 0,60 | PE: approx. 0,35 | HDPE: approx. 0,30

PU85A blue, reinforced glass fibre PU



approx. 88° Shore A

Order No.	Profile dimension mm	Cross section cm ²	approx. weight kg/100m	Standard Roll		Recommended Min. pulley Ø		Fmax/belt (Standard)	
				m	ft	mm	inch	kg	lbs
FBBK17X19LGA	17 x 19	2,13	25,6	30	100	260	10,4	85,2	187,4
FBBK22X25LGA	22 x 25	3,65	43,8	30	100	300	12	146,0	321,2

Recommended pretension: 0,5 - 2 %, **Coeff. of friction μ** : Steel: approx. 0,60 | PE: approx. 0,35 | HDPE: approx. 0,30

PU95A beige

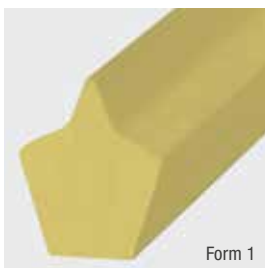

approx. 95° Shore A

Order No.	Profile dimension mm	Cross section cm ²	approx. weight kg/100m	Standard Roll		Recommended Min. pulley Ø		Fmax/belt (Standard)	
				m	ft	mm	inch	kg	lbs
FBAM17X19BG	17 x 19	1,95	23,6	30	100	200	8	97,5	214,5
FBAM22X25BG	22 x 25	3,26	39,1	30	100	250	10	163,0	358,6

Recommended pretension: 3...5 %, **Coeff. of friction μ** : Steel: approx. 0,45 | PE: approx. 0,25 | HDPE: approx. 0,20

PU95A beige

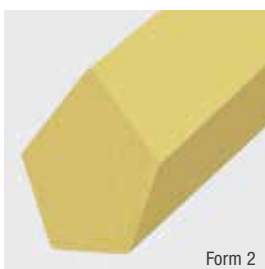

approx. 95° Shore A

Order No.	Profile dimension mm	Cross section cm ²	approx. weight kg/100m	Standard Roll		Recommended Min. pulley Ø		Fmax/belt (Standard)	
				m	ft	mm	inch	kg	lbs
FBBM17X19BG	17 x 19	2,13	25,6	30	100	210	8,4	106,5	234,3
FBBM22X25BG	22 x 25	3,65	43,8	30	100	260	10,4	182,5	401,5

Recommended pretension: 3...5 %, **Coeff. of friction μ** : Steel: approx. 0,45 | PE: approx. 0,25 | HDPE: approx. 0,20



T-Profiles

T-profiles are ideal solutions for conveying of light goods and foodstuffs, whereas usually several T-profile belts are running side by side. The integrated V-guide on the running side prevents the profiles from running sideways and thus guarantees precise straight running. The BEHAbelt portfolio includes T-profiles in various geometries, PU-shore hardnesses and colour combinations.

T-Profile PU70A ultramarine blue smooth (9 x 4 mm)

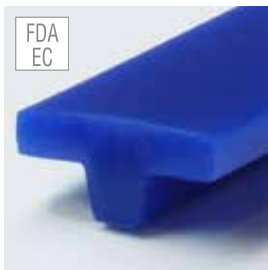

approx. 76° Shore A

Order No.	Profile dimension mm	Cross section cm ²	approx. Weight kg/100m	Standard Roll		Recommended Min. pulley Ø		Fmax/belt (Standard)	
				m	ft	mm	inch	kg	lbs
FBTH9X4GL	9 x 4	0,23	2,8	70	230	25	1,0	4,5	9,9

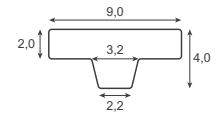

Recommended pretension: 4...8 %

Coeff. of friction μ : Steel: approx. 0,75 | PE: approx. 0,50 | HDPE: approx. 0,45 | FDA/EC/USDA compliant

T-Profile PU65A ultramarine blue smooth (9,5 x 3,5 mm)



approx. 72° Shore A

Order No.	Profile dimension mm	Cross section cm ²	approx. Weight kg/100m	Standard Roll		Recommended Min. pulley Ø		Fmax/belt (Standard)	
				m	ft	mm	inch	kg	lbs
FBTG95X35LA	9,5 x 3,5	0,20	2,4	70	230	20	0,8	2,9	6,4



Recommended pretension: 4...8 %

Coeff. of friction μ : Steel: approx. 0,75 | PE: approx. 0,50 | HDPE: approx. 0,45 | FDA/EC/USDA compliant

T-Profile PU80A ultramarine blue smooth (9,5 x 3,5 mm)

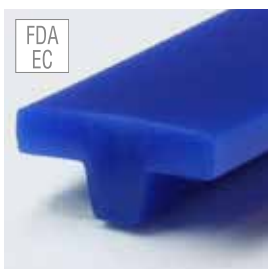

approx. 84° Shore A

Order No.	Profile dimension mm	Cross section cm ²	approx. Weight kg/100m	Standard Roll		Recommended Min. pulley Ø		Fmax/belt (Standard)	
				m	ft	mm	inch	kg	lbs
FBTJ95X35L	9,5 x 3,5	0,20	2,4	30	100	30	1,2	5,2	11,4



Recommended pretension: 4...8 %

Coeff. of friction μ : Steel: approx. 0,65 | PE: approx. 0,35 | HDPE: approx. 0,30 | FDA/EC/USDA compliant

T-Profile PU85A ultramarine blue smooth (9,5 x 3,5 mm)

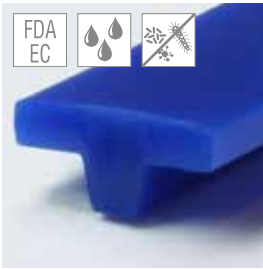

Order No.	Profile dimension mm	Cross section cm ²	approx. Weight kg/100m	Standard Roll		Recommended Min. pulley Ø		Fmax/belt (Standard)	
				m	ft	mm	inch	kg	lbs
FBTK95X35L	9,5 x 3,5	0,20	2,4	30	100	50	2,0	6,0	13,2

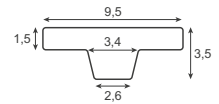

Recommended pretension: 3...6 %

approx. 88° Shore A

Coeff. of friction μ : Steel: approx. 0,65 | PE: approx. 0,35 | HDPE: approx. 0,30 | **FDA/EC/USDA compliant**

T-Profile PU80A ultramarine blue smooth (10 x 4,5 mm)

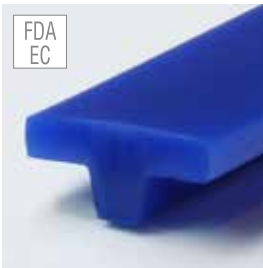

Order No.	Profile dimension mm	Cross section cm ²	approx. Weight kg/100m	Standard Roll		Recommended Min. pulley Ø		Fmax/belt (Standard)	
				m	ft	mm	inch	kg	lbs
FBTI2X45X10L	10 x 4,5	0,27	3,3	30	100	40	1,6	8,1	17,8

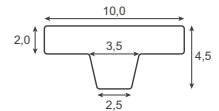

Recommended pretension: 4...8 %

approx. 84° Shore A

Coeff. of friction μ : Steel: approx. 0,65 | PE: approx. 0,35 | HDPE: approx. 0,30 | **FDA/EC/USDA compliant**

T-Profile PU60A blue smooth (15 x 5 mm)



Order No.	Profile dimension mm	Cross section cm ²	approx. Weight kg/100m	Standard Roll		Recommended Min. pulley Ø		Fmax/belt (Standard)	
				m	ft	mm	inch	kg	lbs
FBTF15X5LG	15 x 5	0,44	5,3	50	164	25	1,0	4,5	9,9

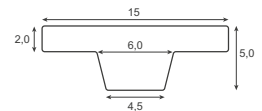

Recommended pretension: 4...8 %

approx. 65° Shore A

Coeff. of friction μ : Steel: approx. 0,90 | PE: approx. 0,65 | HDPE: approx. 0,60 | **FDA/EC compliant (Limited suitability EC)**

T-Profile PU65A ultramarine blue smooth (15 x 5 mm)



Order No.	Profile dimension mm	Cross section cm ²	approx. Weight kg/100m	Standard Roll		Recommended Min. pulley Ø		Fmax/belt (Standard)	
				m	ft	mm	inch	kg	lbs
FBTG15X5LG	15 x 5	0,44	5,3	50	164	30	1,2	8,1	17,8

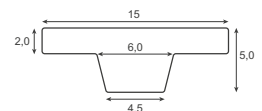

Recommended pretension: 4...8 %

approx. 72° Shore A

Coeff. of friction μ : Steel: approx. 0,75 | PE: approx. 0,50 | HDPE: approx. 0,45 | **FDA/EC compliant**

T-Profile PU80A ultramarine blue smooth (15 x 5 mm)

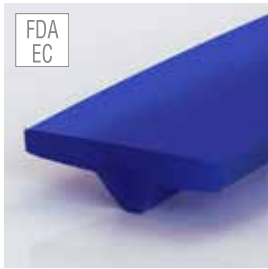

FDA
EC

Order No.	Profile dimension mm	Cross section cm ²	approx. Weight kg/100m	Standard Roll		Recommended Min. pulley Ø		Fmax/belt (Standard)	
				m	ft	mm	inch	kg	lbs
FBTJ15X5L	15 x 5	0,40	4,8	50	164	40	1,6	9,6	21,1

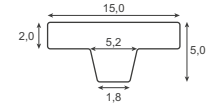

Recommended pretension: 4...8 %

approx. 84° Shore A

Coeff. of friction μ : Steel: approx. 0,65 | PE: approx. 0,35 | HDPE: approx. 0,30 | **FDA/EC/USDA compliant**

T-Profile PU75A sky blue smooth (8 x 5 mm)

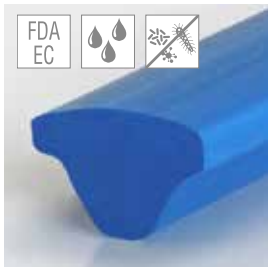

FDA
EC



Order No.	Profile dimension mm	Cross section cm ²	approx. Weight kg/100m	Standard Roll		Recommended Min. pulley Ø		Fmax/belt (Standard)	
				m	ft	mm	inch	kg	lbs
FBSP75A8X5HI	8 x 5	0,25	3,1	40	131	30	1,2	6,0	13,2

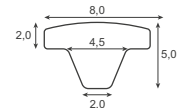

Recommended pretension: 4...8 %

approx. 80° Shore A

Coeff. of friction μ : Steel: approx. 0,70 | PE: approx. 0,40 | HDPE: approx. 0,35 | **FDA/EC/USDA compliant**

3L T-Top PU80A orange smooth (14,3 x 7,5 mm)



FDA
EC

Order No.	Profile dimension mm	Cross section cm ²	approx. Weight kg/100m	Standard Roll		Recommended Min. pulley Ø		Fmax/belt (Standard)	
				m	ft	mm	inch	kg	lbs
FBTJ142X750	14,3 x 7,5	0,72	8,7	30	100	80	3,1	17,3	38,1

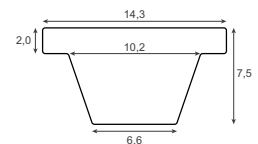

Recommended pretension: 3...6 %

approx. 84° Shore A

Coeff. of friction μ : Steel: approx. 0,65 | PE: approx. 0,35 | HDPE: approx. 0,30 | **FDA/EC/USDA compliant**

Crown Top PU80A orange smooth (14,3 x 6,3 mm)



FDA
EC

Order No.	Profile dimension mm	Cross section cm ²	approx. Weight kg/100m	Standard Roll		Recommended Min. pulley Ø		Fmax/belt (Standard)	
				m	ft	mm	inch	kg	lbs
FBTJ143X630G	14,3 x 6,3	0,58	7,0	30	100	80	3,1	13,9	30,6

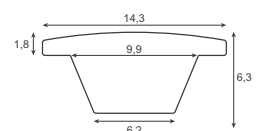

Recommended pretension: 3...6 %

approx. 84° Shore A

Coeff. of friction μ : Steel: approx. 0,65 | PE: approx. 0,35 | HDPE: approx. 0,30 | **FDA/EC/USDA compliant**

T-Profile PU80A half-round orange smooth (19,2 x 5,5 mm)



FDA
EC

Order No.	Profile dimension mm	Cross section cm ²	approx. Weight kg/100m	Standard Roll		Recommended Min. pulley Ø		Fmax/belt (Standard)	
				m	ft	mm	inch	kg	lbs
FBTJ192X550G	19,2 x 5,5	0,65	7,8	30	100	40	1,6	15,6	34,3

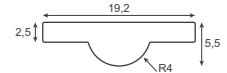

Recommended pretension: 3...6 %

approx. 84° Shore A

Coeff. of friction μ : Steel: approx. 0,65 | PE: approx. 0,35 | HDPE: approx. 0,30 | **FDA/EC/USDA compliant**

T-Profile PU80A half-round orange smooth (12,7 x 5,5 mm)



FDA
EC

Order No.	Profile dimension mm	Cross section cm ²	approx. Weight kg/100m	Standard Roll		Recommended Min. pulley Ø		Fmax/belt (Standard)	
				m	ft	mm	inch	kg	lbs
FBTJ127X550G	12,7 x 5,5	0,44	5,6	30	100	40	1,6	11,2	24,6

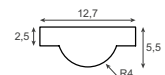

Recommended pretension: 3...6 %

approx. 84° Shore A

Coeff. of friction μ : Steel: approx. 0,65 | PE: approx. 0,35 | HDPE: approx. 0,30 | **FDA/EC/USDA compliant**



T-Profiles for packaging industry

T-profiles are ideal for transporting various light goods and foodstuffs, with several T-profile belts usually running next to each other. The integrated guide wedge on the running side prevents the profiles from running sideways and thus guarantees precise straight running. The BEHAbelt portfolio includes T-profiles in various geometries, PU shore hardnesses and colour combinations.

T-Profile PU85A (25 x 5 mm) green or white embossed (EFI) / smooth

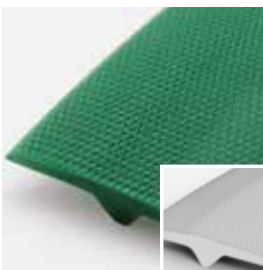

● ○ also available: smooth

Order No.	Profile dimension mm	Cross section cm ²	approx. Weight kg/100m	Standard Roll		Recommended Min. pulley Ø		Fmax/belt (Standard)	
				m	ft	mm	inch	kg	lbs
FBTK25X5GW01 (green, embossed)	25 x 5	0,58	7,0	50	164	50	2,0	16,0	35,2
FBSP85A25X5 (green, smooth)	25 x 5	0,58	7,0	50	164	50	2,0	16,0	35,2
FBTK25X5WW01 (white, embossed)	25 x 5	0,58	7,0	50	164	50	2,0	16,0	35,2
FBSP85A25X5A (white, smooth)	25 x 5	0,58	7,0	50	164	50	2,0	16,0	35,2

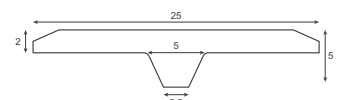

approx. 88° Shore A

Recommended pretension: 3...6 %, **Coeff. of friction μ :** Steel: approx. 0,60 | PE: approx. 0,35 | HDPE: approx. 0,30

T-Profile PU85A sapphire blue smooth / ribbed (LGD)* (25 x 5 mm)

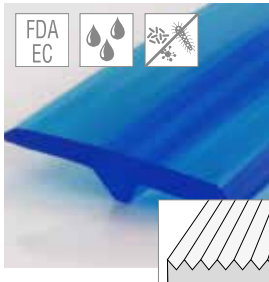

Order No.	Profile dimension mm	Cross section cm ²	approx. Weight kg/100m	Standard Roll		Recommended Min. pulley Ø		Fmax/belt (Standard)	
				m	ft	mm	inch	kg	lbs
FBSP85A25X5B	25 x 5	0,59	7,3	50	164	50	2,0	15,2	33,4
FBTK25X5LGA (ribbed)	25 x 5	0,59	7,3	50	164	50	2,0	15,2	33,4

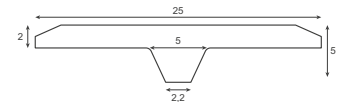

*Longitudinal grooves (LGD)

Recommended pretension: 3...6 %

approx. 88° Shore A

Coeff. of friction μ : Steel: approx. 0,60 | PE: approx. 0,35 | HDPE: approx. 0,30 | FDA/EC/USDA compliant

T-Profile PU85A white or sapphire blue (20 x 8 mm)

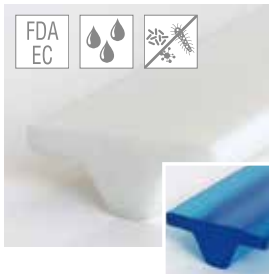

Order No.	Profile dimension mm	Cross section cm ²	approx. Weight kg/100m	Standard Roll		Recommended Min. pulley Ø		Fmax/belt (Standard)	
				m	ft	mm	inch	kg	lbs
FBSP85A20X8W (white)	20x8	0,83	10,0	30	100	100	4,0	21,4	47,1
FBSP85A20X8 (sapphire blue)	20x8	0,83	10,0	30	100	100	4,0	21,4	47,1

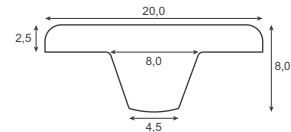

Recommended pretension: 3...6 %

approx. 88° Shore A

Coeff. of friction μ : Steel: approx. 0,60 | PE: approx. 0,35 | HDPE: approx. 0,30 | FDA/EC/USDA compliant

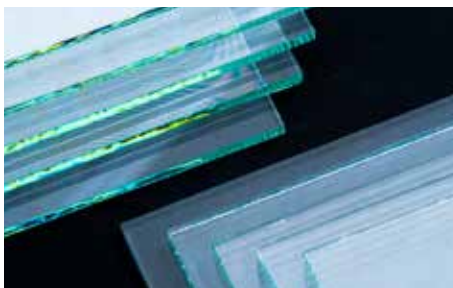

Glass industry

The special „Wing Top“ profile is ideal for the gentle transport of flat glass or similar sheet products.

Wing Top PU80A orange smooth

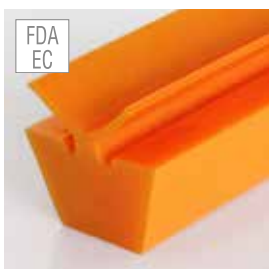

Order No.	Profile dimension mm	Cross section cm ²	approx. weight kg/100m	Standard roll		Recommended Min. pulley Ø		Fmax/belt (Standard)	
				m	ft	mm	inch	kg	lbs
FBSI17X100G	17 x 11 x 16,5	1,56	18,7	30	100	125	4,9	35,1	77,2

Recommended pretension: 3...6 %

approx. 84° Shore A

Coeff. of friction μ : Steel: approx. 0,65 | PE: approx. 0,35 | HDPE: approx. 0,30 | FDA/EC/USDA compliant



Profiles for French fries / potato strips

Profiles to support the automatic elimination of defects in potato strips (French fries). Made of special hydrolysis resistant PU that ensures longer life and less bacterial growth in wet environment. The dirt-repellent material reduces discoloration and improves the visual appearance of the profiles.
High-quality PU ensures strong welding seams.

U-Profile PU85A milky smooth

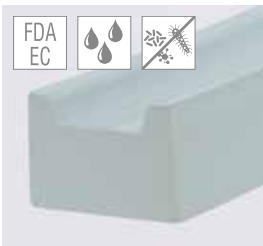

approx. 88° Shore A

Order No.	Profile dimension mm	Cross section cm ²	approx. Weight kg/100m	Standard Roll		Recommended Min. pulley Ø		Fmax/belt (Standard)	
				ft	mm	inch	kg	lbs	
FBSP85A180S1	18 x 11,8	1,70	20,0	1 x 30'5" / pc.		120	4,7	43,9	96,6
FBSP85A180S6	18 x 11,8	1,70	20,0	6 x 30'5" / pc.		120	4,7	43,9	96,6

Recommended pretension: 3...6 %

Coeff. of friction μ : Steel: approx. 0,60 | PE: approx. 0,35 | HDPE: approx. 0,30 | FDA/EC/USDA compliant

Square Profile PU85A milky smooth

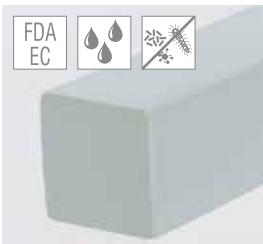

approx. 88° Shore A

Order No.	Profile dimension mm	Cross section cm ²	approx. weight kg/100m	Standard Roll		Recommended Min. pulley Ø		Fmax/belt (Standard)	
				ft	mm	inch	kg	lbs	
FBSP85A118S1	11,8 x 11,8	1,39	16,7	1 x 30'5" / pc.		120	4,7	35,9	79,0
FBSP85A118S6	11,8 x 11,8	1,39	16,7	6 x 30'5" / pc.		120	4,7	35,9	79,0

Recommended pretension: 3...6 %

Coeff. of friction μ : Steel: approx. 0,60 | PE: approx. 0,35 | HDPE: approx. 0,30 | FDA/EC/USDA compliant



Profile for Corn and similar goods

Special profile for peeling machines. The central recess in the profile ensures that the conveyed products are precisely positioned and transferred to the next processing step.

Corn belt PU80A orange smooth without* / with serrations



approx. 84° Shore A

Order No.	Profile dimension mm	Cross section cm ²	approx. Weight kg/100m	Standard Roll		Recommended Min. pulley Ø		Fmax/belt (Standard)	
				m	ft	mm	inch	kg	lbs
FBSJ8X330G*	33 x 8	1,9	22,8	30	100	50	2,0	45,6	100,3
FBSJ8X330GA	33 x 8	1,9	22,8	30	100	50	2,0	45,6	100,3

Recommended pretension: 3...6 %

Coeff. of friction μ : Steel: approx. 0,65 | PE: approx. 0,35 | HDPE: approx. 0,30 | FDA/EC/USDA compliant



Spreading applications

In spreading applications, these profiles allow product strands to be pulled apart, e.g. in the confectionery industry. The dedicated selection of material and Shore hardness can improve the release properties of sticky products.

PU80A orange 3-ribbed



Order No.	Profile dimension mm	Cross section cm ²	approx. weight kg/100m	Standard Roll		Recommended Min. pulley Ø		Fmax/belt (Standard)	
				m	ft	mm	inch	kg	lbs
FBSI17B0GR3	17 x 11 (B)	1,46	18,0	30	100	110	4,3	43,8	96,4
FBSI22C0GR3	22 x 14 (C)	2,40	29,0	30	100	150	5,9	72,0	158,4

Recommended pretension: 4...8 %

approx. 84° Shore A

Coeff. of friction μ : Steel: approx. 0,65 | PE: approx. 0,35 | HDPE: approx. 0,30 | FDA/EC/USDA compliant

PU85A (15 x 10 mm) sapphire blue

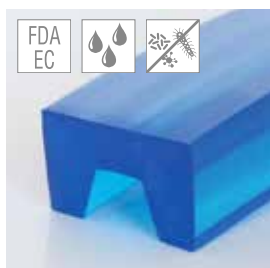

Order No.	Profile dimension mm	Cross section cm ²	approx. weight kg/100m	Standard roll		Recommended Min. pulley Ø		Fmax/belt (Standard)	
				m	ft	mm	inch	kg	lbs
FBSK15X10LG	15 x 10	1,2	14	30	100	100	3,9	41,0	90,2

Recommended pretension 4...8 %

approx. 88° Shore A

Coeff. of friction μ : Steel: approx. 0,60 | PE: approx. 0,35 | HDPE: approx. 0,30

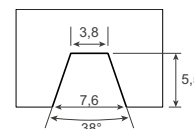

PU95A (12 x 8 mm) beige

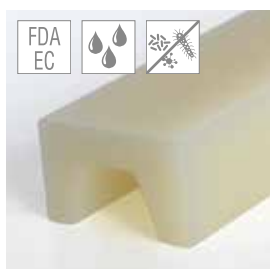

Order No.	Profile dimension mm	Cross section cm ²	approx. weight kg/100m	Standard roll		Recommended Min. pulley Ø		Fmax/belt (Standard)	
				m	ft	mm	inch	kg	lbs
FBSM12X8BG	12 x 8	0,67	7,9	50	164	120	4,7	32,7	71,9

Recommended pretension 3...5 %, Coeff. of friction μ : Steel: approx. 0,45 | PE: approx. 0,25 | HDPE: approx. 0,20

approx. 95° Shore A

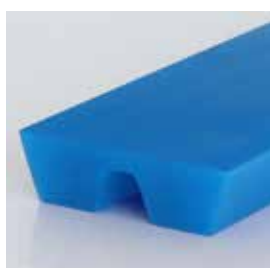
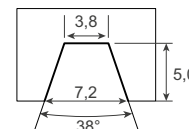

Please also note other Twin V-belts on page 37.

PU80A V-belt ultramarine blue (10 x 8 mm)

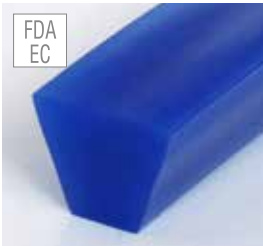

approx. 84° Shore A

Order No.	Profile dimension mm	Cross section cm ²	approx. Weight kg/100 m	Standard Roll		Recommended Min. pulley Ø		Fmax/belt (Standard)	
				m	ft	mm	inch	kg	lbs
FBKJ10X8BGA	10 x 8	0,58	6,9	100	328	80	3,1	18,6	40,9

Recommended pretension: 3...6 %

Coeff. of friction μ : Steel: approx. 0,65 | PE: approx. 0,35 | HDPE: approx. 0,30 | FDA/EC/USDA compliant

PU85A V-belt ultramarine blue (10 x 8 mm), reinforced Aramid

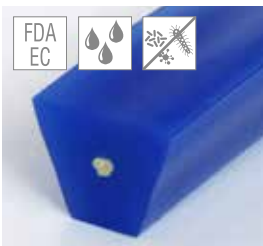

approx. 88° Shore A

Order No.	Profile dimension mm	Cross section cm ²	approx. Weight kg/100 m	Standard Roll		Recommended Min. pulley Ø		Fmax/belt (Standard)	
				m	ft	mm	inch	kg	lbs
FBKK10X8LGA	10 x 8	0,58	6,9	50	164	85	3,3	19,9	43,8

Recommended pretension: 0,5...2 %

Coeff. of friction μ : Steel: approx. 0,60 | PE: approx. 0,35 | HDPE: approx. 0,30 | FDA/EC/USDA compliant



Sorting of fruit and vegetables

This is just one example for the use of special profiles from the BEHAbelt product portfolio. Thanks to many years of experience and our own tool shop we can realize customer and application specific profiles within very short time.

PU80A Pear Profile (28 x 29 mm) white reinforced Polyester

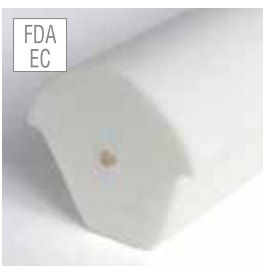

approx. 84° Shore A

Order No.	Profile dimension mm	Cross section cm ²	approx. weight kg/100 m	Standard Roll		Recommended Min. pulley Ø		Fmax/belt (Standard)	
				m	ft	mm	inch	kg	lbs
FBSJ28X29WG	28 x 29	5,1	61	30	100	350	13,8	163,6	360

Recommended pretension: 0,5...2 %

Coeff. of friction μ : Steel: approx. 0,65 | PE: approx. 0,35 | HDPE: approx. 0,30 | FDA/EC/USDA compliant



Slicer

For slicer applications and the downstream feeding lines BEHAbelt has different product options in its product range. Depending on the conveyed goods, extruded round belts, V-belts or T-profiles with special material properties and surface structures can be used.

V-belts with a curved surface are proven to be particularly suitable for Transport of sliced cheese proven.

PU75A ultramarine blue smooth with vaulted top

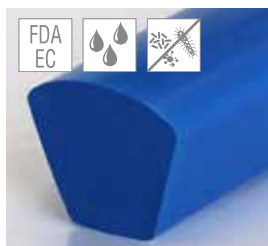

approx. 80° Shore A

Order No.	Profile dimension mm	Cross section cm ²	approx. Weight kg/100 m	Standard Roll		Recommended Min. pulley Ø		Fmax/belt (Standard)	
				m	ft	mm	inch	kg	lbs
FBSP75A0865U	8 x 6,5 (M)	0,39	4,6	50	164	40	1,6	10,0	22,0

Recommended pretension: 4...8 %

Coeff. of friction μ : Steel: approx. 0,70 | PE: approx. 0,40 | HDPE: approx. 0,35 | **FDA/EC/USDA compliant**

PU80A ultramarine blue smooth with vaulted top

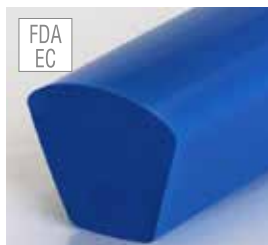

approx. 84° Shore A

Order No.	Profile dimension mm	Cross section cm ²	approx. Weight kg/100 m	Standard Roll		Recommended Min. pulley Ø		Fmax/belt (Standard)	
				m	ft	mm	inch	kg	lbs
FBSP80A0865U	8 x 6,5 (M)	0,39	4,6	50	164	50	2,0	11,0	24,2

Recommended pretension: 4...8 %

Coeff. of friction μ : Steel: approx. 0,65 | PE: approx. 0,35 | HDPE: approx. 0,30 | **FDA/EC/USDA compliant**

PU85A ultramarine blue smooth with vaulted top

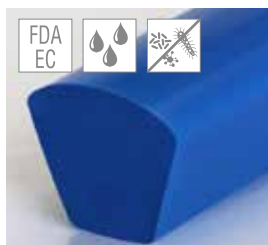

approx. 88° Shore A

Order No.	Profile dimension mm	Cross section cm ²	approx. Weight kg/100 m	Standard Roll		Recommended Min. pulley Ø		Fmax/belt (Standard)	
				m	ft	mm	inch	kg	lbs
FBSP85A0865U	8 x 6,5 (M)	0,39	4,6	50	164	55	2,2	13,2	29,0

Recommended pretension: 4...8 %

Coeff. of friction μ : Steel: approx. 0,60 | PE: approx. 0,30 | HDPE: approx. 0,25 | **FDA/EC/USDA compliant**



Building materials

For the transport of heavy and abrasive building materials our V-belts guarantee longevity and high wear resistance. In addition to the good temperature resistance, these belts, like all BEHAbelt products, can be quickly and easily welded and are available with or without tension members.

In addition we offer many coatings (see page 36) for different applications.

T-Profile PU95A beige smooth (30 x 9,5 mm)



Order No.	Profile dimension mm	Cross section cm ²	approx. Weight kg/100m	Standard Roll		Recommended Min. pulley Ø		Fmax/belt (Standard)	
				m	ft	mm	inch	kg	lbs
FBTM30X95B	30 x 9,5	1,23	14,8	30	100	110	4,3	45,6	100,3

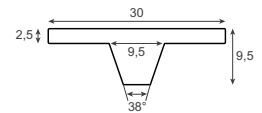

Recommended pretension: 3...5 %

approx. 95° Shore A

Coeff. of friction μ : Steel: approx. 0,45 | PE: approx. 0,25 | HDPE: approx. 0,20 | FDA/EC compliant

T-Profile PU95A beige smooth (50 x 11,5 mm)



Order No.	Profile dimension mm	Cross section cm ²	approx. Weight kg/100m	Standard Roll		Recommended Min. pulley Ø		Fmax/belt (Standard)	
				m	ft	mm	inch	kg	lbs
FBTM50X11B	50 x 11,5	2,43	29,2	30	100	130	5,1	90,1	198,2

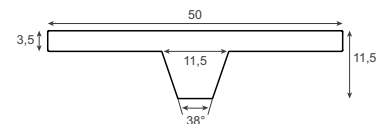

Recommended pretension: 3...5 %

approx. 95° Shore A

Coeff. of friction μ : Steel: approx. 0,45 | PE: approx. 0,25 | HDPE: approx. 0,20 | FDA/EC/USDA compliant

TPE55D V-belt additional height (22 x 16 mm) beige



Order No.	Profile dimension mm	Cross section cm ²	approx. weight kg/100m	Standard Roll		Recommended Min. pulley Ø		Fmax/belt (Standard)	
				m	ft	mm	inch	kg	lbs
FBSR22X16BG	22 x 16	3,12	37	50	164	280	11,0	299,5	659,9

Recommended pretension: 2...4 %

55° Shore D • approx. 100° Shore A

Coeff. of friction μ : Steel: approx. 0,35 | PE: approx. 0,20 | HDPE: approx. 0,15 | FDA/EC/USDA compliant



Intralogistics – Roller conveyors

These special profiles have optimised material properties for reliable use in roller conveyors, whether as tangential drive, roller-to-roller drive or crossed drive. Please also look at our round belt range page 12 and following.

PU75A plus Poly V-belt, orange



approx. 80° Shore A

Order No.	Description	Profile dimension	Cross section	approx. weight	Standard roll		Recommended Min. pulley Ø		Fmax/belt (Standard)	
		mm	cm ²	kg/100 m	m	ft	mm	inch	kg	lbs
FBPVIPJ20	PJ2	4,8 x 4	0,16	1,96	200	656	30	1,2	7,2	15,8
FBPVIPJ30	PJ3	7 x 4	0,24	2,93	200	656	30	1,2	10,5	23,1
FBPVIPJ40	PJ4	9,3 x 4	0,32	3,92	200	656	30	1,2	14,4	31,7

Recommended pretension: 3...6 %, **Coeff. of friction μ** : Steel: approx. 0,70 | PE: approx. 0,40 | HDPE: approx. 0,35

PU85A plus Poly V-belt, ultramarine blue



approx. 88° Shore A

Order No.	Description	Profile dimension	Cross section	approx. weight	Standard roll		Recommended Min. pulley Ø		Fmax/belt (Standard)	
		mm	cm ²	kg/100 m	m	ft	mm	inch	kg	lbs
FBPVKPJ2L	PJ2	4,8 x 4	0,16	1,96	200	656	40	1,6	10,3	22,7
FBPVKPJ3L	PJ3	7 x 4	0,24	2,93	200	656	40	1,6	15,0	33,1
FBPVKPJ4L	PJ4	9,3 x 4	0,32	3,92	200	656	40	1,2	20,6	45,4

Recommended pretension: 3...6 %, **Coeff. of friction μ** : Steel: approx. 0,60 | PE: approx. 0,30 | HDPE: approx. 0,25

PU to rubber Poly V-belt conversion

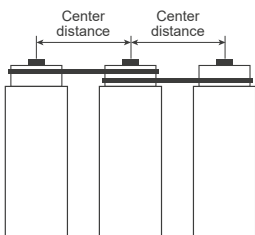

Centre distance for pulley Ø 43 mm	Production length BEHAbelt*	PJ2	PJ3	PJ4
		nominal length specification		
53 - 56	234	Ref. 2PJ246-43	Ref. 3PJ246-43	Ref. 4PJ246-43
60 - 63	243	Ref. 2PJ256-43	Ref. 3PJ256-43	Ref. 4PJ256-43
64 - 65	252	Ref. 2PJ265-43	Ref. 3PJ265-43	Ref. 4PJ265-43
66 - 67	257	Ref. 2PJ270-43	Ref. 3PJ270-43	Ref. 4PJ270-43
71 - 72	268	Ref. 2PJ282-43	Ref. 3PJ282-43	Ref. 4PJ282-43
73 - 75	272	Ref. 2PJ286-43	Ref. 3PJ286-43	Ref. 4PJ286-43
76 - 77	276	Ref. 2PJ290-43	Ref. 3PJ290-43	Ref. 4PJ290-43
78 - 79	274	Ref. 2PJ288-43	Ref. 3PJ288-43	Ref. 4PJ288-43
80 - 84	287	Ref. 2PJ302-43	Ref. 3PJ302-43	Ref. 4PJ302-43
87 - 91	298	Ref. 2PJ314-43	Ref. 3PJ314-43	Ref. 4PJ314-43
92 - 95	300	Ref. 2PJ316-43	Ref. 3PJ316-43	Ref. 4PJ316-43
97 - 101	319	Ref. 2PJ336-43	Ref. 3PJ336-43	Ref. 4PJ336-43
103 - 107	329	Ref. 2PJ346-43	Ref. 3PJ346-43	Ref. 4PJ346-43
115 - 118	353	Ref. 2PJ372-43	Ref. 3PJ372-43	Ref. 4PJ372-43
119 - 121	357	Ref. 2PJ376-43	Ref. 3PJ376-43	Ref. 4PJ376-43
123 - 128	369	Ref. 2PJ388-43	Ref. 3PJ388-43	Ref. 4PJ388-43

* general pretension of 5% to the nominal length specification

TPE55D *bluepower* smooth, with/without reinforced Polyester

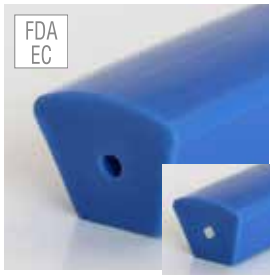

Order No.	Profile dimension mm	Cross section cm ²	approx. weight kg/100m	Standard Roll		Recommended Min. pulley Ø		Fmax/belt (Standard)		Fmax/belt (Overlap)	
				m	ft	mm	inch	kg	lbs	kg	lbs
FBKBLP17113W	16,35 x 11,3	1,49	18,0	50	164	175	7,0	119,2	262,2	n/a	n/a
FBKBLP1711W2	16,35 x 11,3	1,49	18,0	100	328	175	7,0	119,2	262,2	n/a	n/a
FBKBLP1711W3	16,35 x 11,3	1,49	18,0	100	328	180	7,1	119,2	262,2	150,0	330,0

Recommended pretension: 2...4 % (without reinforcement), 0,5...2% (with reinforcement)

55° Shore D · approx. 100° Shore A

Coeff. of friction μ : Steel: approx. 0,35 | PE: approx. 0,20 | HDPE: approx. 0,15 | **FDA/EC/USDA compliant**

TPE55D beige smooth with chamfer, with/without reinforced Polyester



Order No.	Profile dimension mm	Cross section cm ²	approx. weight kg/100m	Standard roll		Recommended Min. pulley Ø		Fmax/belt (Standard)		Fmax/belt (Overlap)	
				m	ft	mm	inch	kg	lbs	kg	lbs
FBKH55D17115	17 x 11,4	1,45	18,0	100	328	175	7,0	116,0	255,2	n/a	n/a
FBKS17115BGA	17 x 11,4	1,45	18,0	100	328	180	7,1	116,0	255,2	150,0	330,0

Recommended pretension: 2...4 % (without reinforcement), 0,5...2 % (with reinforcement)

55° Shore D · approx. 100° Shore A

Coeff. of friction μ : Steel: approx. 0,35 | PE: approx. 0,20 | HDPE: approx. 0,15 | **FDA/EC/USDA compliant**

PU80A Double V-belt black (17 x 13,5 mm)



Order No.	Profile dimension mm	Cross section cm ²	approx. weight kg/100m	Standard roll		Recommended Min. pulley Ø		Fmax/belt (Standard)	
				m	ft	mm	inch	kg	lbs
FBSJ17X13SG	17 x 13,5	1,92	2,3	50	164	150	5,9	61,6	135,5

approx. 84° Shore A

Recommended pretension: 3...6 %, **Coeff. of friction μ :** Steel: approx. 0,65 | PE: approx. 0,35 | HDPE: approx. 0,30

PU85A Double V-belt black (17 x 13,5 mm)



Order No.	Profile dimension mm	Cross section cm ²	approx. weight kg/100m	Standard roll		Recommended Min. pulley Ø		Fmax/belt (Standard)	
				m	ft	mm	inch	kg	lbs
FBSK17X13SG	17 x 13,5	1,92	2,3	50	164	160	6,3	69,7	153,3

approx. 88° Shore A

Recommended pretension: 3...6 %, **Coeff. of friction μ :** Steel: approx. 0,60 | PE: approx. 0,30 | HDPE: approx. 0,25

Didn't find your belt?

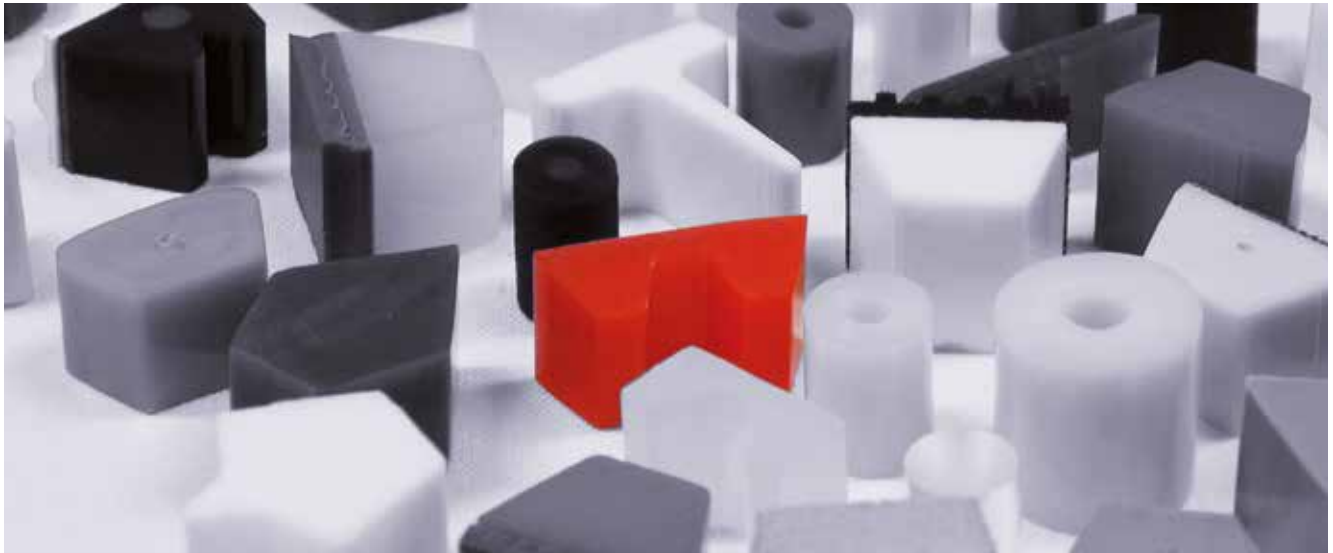

no minimum order quantities

according to your specifications

in only 4-8 weeks

BEHAbelt offers you the exclusive and fast delivery of your desired profile or conveyor belt!

If a standard profile does not meet the requirements of your application, BEHAbelt offers you the unique opportunity to develop a customer-specific product. According to your specifications and your design!

Tell us about your application!

Thanks to our modern in-house tool shop, we are able to produce special profiles for you in the shortest possible time. On page 136 you will find the technical inquiry template; it helps to gather the most important information to fulfil your request.

FAST DELIVERY (4-8 WEEKS)

- Many years of experience, in-house manufacturing of tooling, individual consulting
- Development of customised profiles and conveyor belts
- Designed specifically for your application
- According to your design

ECONOMIC ADVANTAGES

- Exclusivity / securing the After Sales Market
- Material combination
- Optimization of your application through the perfect profile
- Improved service life and functionality
- Appropriate welding technology

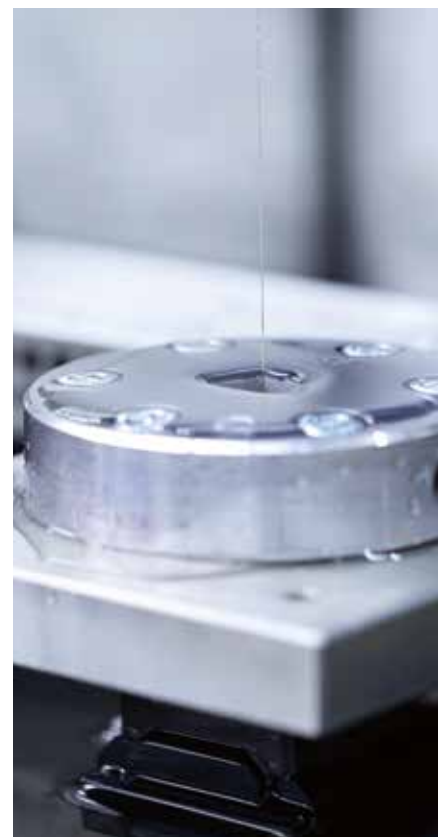

CONVEYOR

BELTS

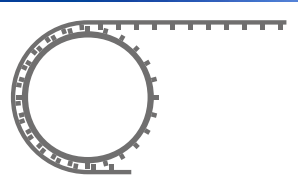

Slip-free (p. 61)

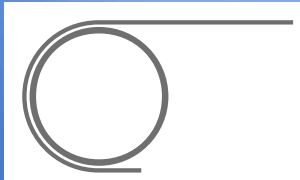

Friction driven (p. 62)

ELASTIC MONOLITHIC CONVEYOR BELTS

Applications, Industries, Product features	56
Overview belt structures.....	59
Table structure key	60
Slip-free conveyor belts	61
Conveyor belts up to 750 mm.....	62
Conveyor belts for intralogistics.....	67
Machine tapes.....	68
Elastic conveyor belts up to 360 mm	69
Elastic conveyor belts up to 140 mm	69
Welding electrodes.....	94

Elastic monolithic conveyor belts

BEHAbelt offers innovative and quality solutions. There is already a huge variety of belting categories and design variations available on the market. However, the increasing automation of industrial production processes and machines requires ongoing evolution. Only if all components and their features keep pace, real improvements in terms of efficiency, capacity and safety can be achieved.

This is where the new elastic monolithic conveyor belts by BEHAbelt deliver an important contribution. These products enable longer life and minimize risks like cover and ply delamination or edge fraying versus conventional coated conveyor belts with fabric carcasses.

BEHAbelt offers both friction and positive driven conveyor belts for your applications.



Advantages

PRODUCT DESIGN

- No risk of contamination based on exposed belt fabrics or due to mechanical damage to belt edges
- Part of a preventive hygienic machinery design concerning food safety
- Excellent cleanability and microbial resistance
- Homogeneously added product feature options: Metal detectable, X-ray detectable, UV-C resistant, antistatic discharging

HANDLING

- Easy installation of elastic belt versions due to elasticity
- Softer belts allow even a hand mounted possibility with fixed center to center machinery designs without any take up
- Butt-end weldings can be made with a user-friendly tool, which ensures no loss of surface structure, homogeneity and elasticity in the joining
- Accessories such as corrugated sidewalls, cleats, V-guides and other profiles can be welded on excellently.

Industries and applications

Elastic monolithic conveyor belts are especially beneficial for the various applications to convey unwrapped foodstuff. Furthermore, this design and the special features are opening up interesting opportunities way beyond that, for example in:

INDUSTRIES

- Food (Fish, Meat, Poultry, Fruit & Vegetable, Confectionery and Bakery)
- Packaging (Food and Non-Food)
- Pharmacy
- Logistics and Material Handling

APPLICATIONS

- General conveying, Separation and Acceleration
- Weighing, Sorting, Portioning
- Feeding, Cutting, Detecting (metal detectors) and many more

Metal & X-Ray detectable PU80 SAFE

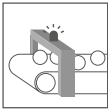

Product contamination with foreign objects, e.g. synthetic particles, is a high risk in food processing.

Metal or X-ray detectors can be used to detect contamination of the food by foreign particles.

Both the elastic monolithic belts and the non-reinforced belt profiles are suitable for trouble-free transport through the inspection area of metal and X-ray detectors. Thanks to the homogeneous design, the measurement results of the detectors are neither distorted nor influenced.

For upstream process sections, the PU80Asafe product series offers the possibility to detect and remove inadvertently inserted strip pieces downstream with a detector. This product series thus makes a preventive contribution to product safety.

2 Components design



Various transport tasks can be optimised by 2-component conveyor belts can be optimised.

Depending on the material to be conveyed or the type of conveyor (e.g. accumulation, inclined conveyor), a wide variety of belt types are required. The 2C process allows both structures to be combined and 2 different degrees of hardness to be combined in one belt.

For example, when designing a belt for an inclined conveyor, the transport side can have more grip, but the running side can have good gliding properties.

MICROclean Surface finish

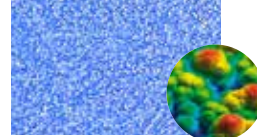

BEHAbelt uses a unique structure finish for the special requirements of the food industry.

The special structure of the MICROclean surface allows better and faster cleaning of the belt surface due to the special surface design, which can only be recognised with a magnifying glass. In addition, the transported products are easier to remove, especially when transferring the product to the next transport section.

The graphic illustrates the principle of MICROclean:

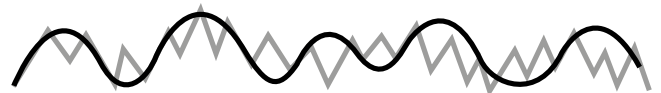

— Belt surface smooth gloss (SG)

— Belt surface MICROclean smooth matt (SM)

Slip-free / Friction driven

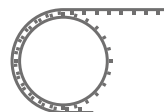

Slip-free AT5 elastic conveyor belts

The positive-driven AT5 conveyor belts from BEHAbelt enable slip-free traction, even with the smallest pulley diameters of only Ø 18 mm. Slip-free because the running side of the elastic belt is designed with a modified AT5 and this fits perfectly on an AT5 pulley due to the pretension of 1.5%.

Friction driven elastic conveyor belts and machine tapes

These conveyor belts are installed in the system with a pretension of 0.5-5%. The precise pretension ensures optimum power transmission and thus optimises the bearing load and ultimately your energy costs. The belts are guided e.g. via crowned pulleys or welded-on V-guides.

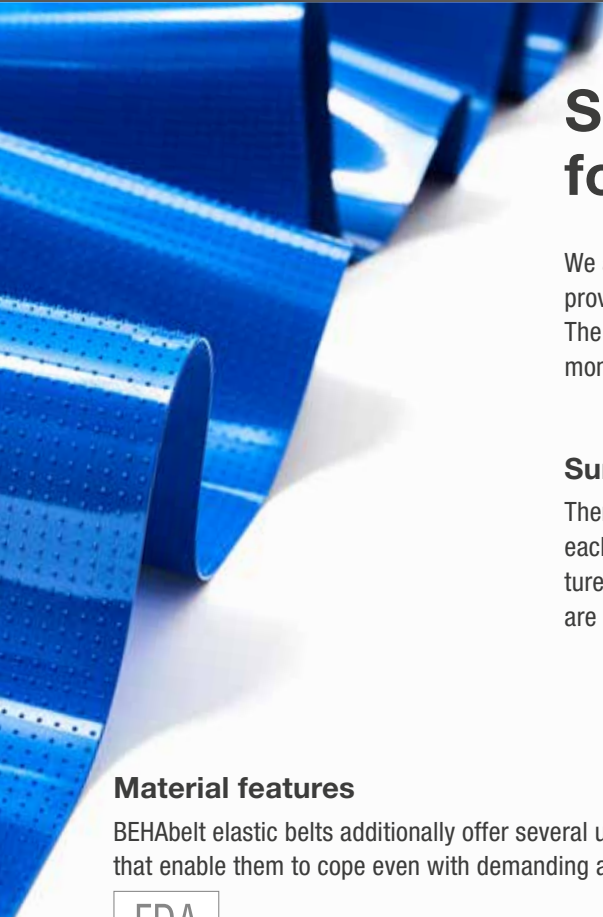

Suitable belt designs for your applications

We aim to understand the challenges and applications of our customers and to provide support through our enhanced product portfolio and know-how. The variety of options to combine surface structures, material features and colors of monolithic conveyor belts, offered by BEHAbelt, are unmatched in the market.

Surface structures

There are currently twelve different structures available, which can be combined with each other in almost any way on the transport and running side. Five of these structures (nub top, diamond, smooth matt as well as longitudinal and transversal grooves) are also available with the unique „MICROclean“ surface finish.

Material features

BEHAbelt elastic belts additionally offer several useful features that enable them to cope even with demanding applications.

- 

FDA/EC conformity for direct contact with food. (see also p. 124)
- 

Metal and X-ray detectable conveyor belts for maximum food safety. These products are part of the PU SAFE range.
- 

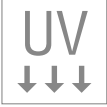
Hydrolysis resistant conveyor belts for optimal performance in warm, wet and humid environment
- 

Specially protected against UV-C waves.
- 

Friction driven conveyor belts for roller conveyors.
- 

BEHAbelt is offering a broad spectrum of possible and even individual color options.

- 

Antistatic conveyor belts to ensure electrical discharge in sensitive applications.
- 

Microbe-resistant materials do not provide a breeding ground for microorganisms.
- 

Unique surface finish that offers optimal release properties and best cleanability due to its rounded structure.
- 

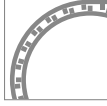
The 2-component production allows the combination of different material hardnesses, properties and colours.
- 

Slip-free conveyor belts for positive drives.

Hardness

BEHAbelt distinguish between two hardness ranges.

SOFT	PU65A, PU75A, PU80A
HARD	PU95A, TPE55D, TPE63D

Thickness

Conveyor belts are available in different thicknesses from 0,9 - 4 mm.

0,9 mm	_____	2 mm	_____
1 mm	_____	2,5 mm	_____
1,2 mm	_____	3 mm	_____
1,6 mm	_____	4 mm	_____

OVERVIEW BELT STRUCTURES

The belt structures shown here can be combined almost arbitrarily. In addition, you have the option of individual colouring and dedicated product properties, such as UV-C resistance or antistatic conductivity.

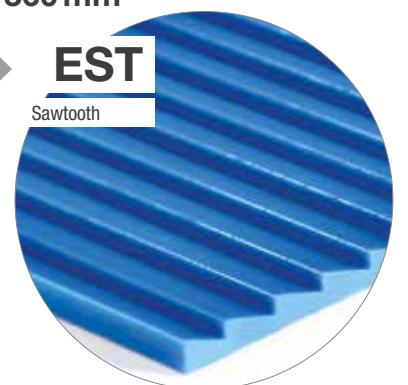
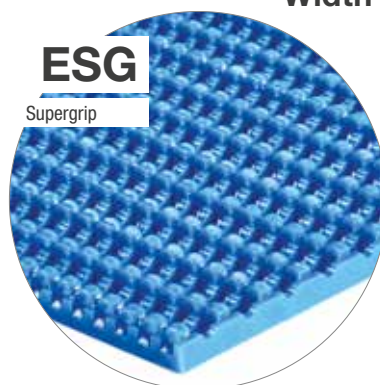
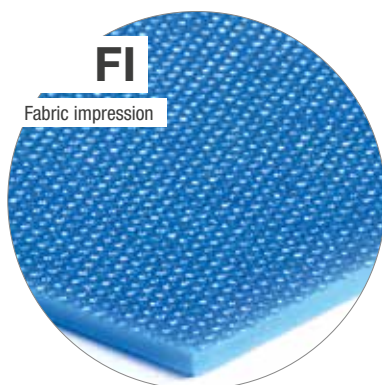
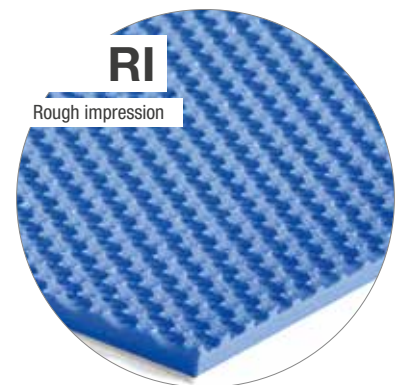
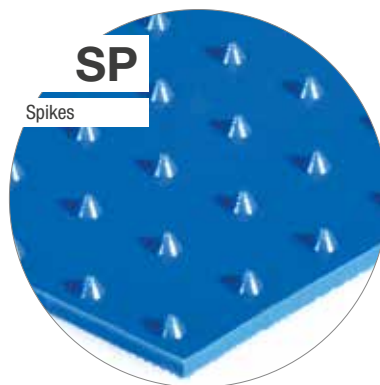
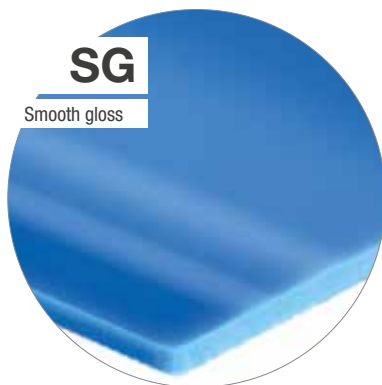
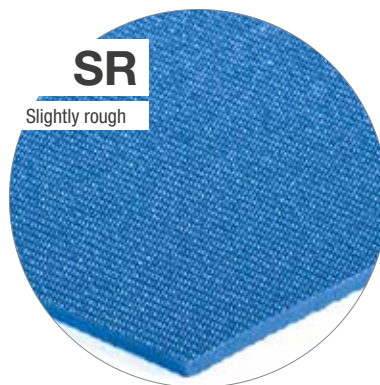
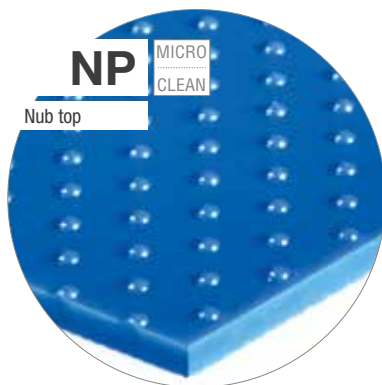
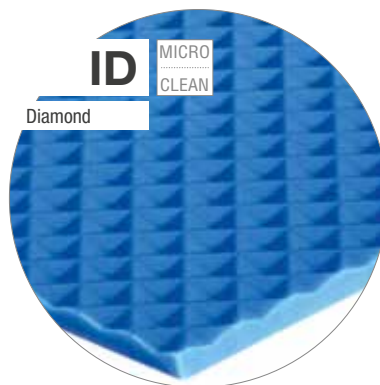



Width up to 360 mm



Table structure key

General explanation of the product tables









Bottom side		Color	Additional features	Quality	Hardness Shore	Profile thickness		Recommended Min. pulley Ø		k1% static		k1% relaxed		Standard roll		Recommended pretension	Order No.
						mm	inch	mm	inch	N/mm	lbs/inch	N/mm	lbs/inch	m	ft		
	Diamant (ID)	UB	MICRO CLEAN	PU80A	84 A	1,0	0,039	10	0,40	0,24	1,32	0,20	1,12	50	164	1-5%	FBFJ750X10LK

Legende

- ① Structure of **bottom side**; shown as image and text
- ② Symbol for product characteristic of the bottom side (see table below for explanation of symbols)
- ③ Structure of **top side**; shown as image and text
- ④ Colour (Caution, original colour may deviate from the graphic; standard colours: ultramarine blue, sky blue, white and black)
- ⑤ Symbol for product characteristic of the **top side** (see table below for explanation of symbols)
- ⑥ BEHAbelt product description
- ⑦ Hardness in Shore A/D
- ⑧ Profile thickness in mm/inch
- ⑨ Recommended minimum pulley diameter (mm). Note: Smaller pulley diameters shorten the service life of the belt.
- ⑩ k1% static – Modulus of elasticity per mm of belt width when the belt is pulled up (max. bearing load)
- ⑪ k1% relaxed – Modulus of elasticity per mm of belt width after running-in of the belt (max. transport weight)
- ⑫ Standard roll (standard delivery)
- ⑬ Recommended pretension* of the belt in the system (in %). Note: A higher pretension increases the axle and bearing loads.

*Calculation formulas and technical know-how starting on page 132

Symbols

							
Antistatic discharge conveyor belts with excellent mechanical properties	Protection against UV-C waves generated by respective disinfection device	Belts with FDA/EC conformity for direct contact with food.	Metal and X-ray detectable conveyor belts for maximum of food safety.	Hydrolysis resistant conveyor belts for use in warm, humid and wet environments.	Microbe-resistant conveyor belts do not provide a breeding ground for microorganisms	Belts made of 2 components enable combination of hardness and features.	Unique surface finish for improved release of sticky goods and excellent cleanability

Colour codes

UB ultramarine blue	CB capri blue	HI sky blue	SW black	TR transparent	WE white
----------------------------	----------------------	--------------------	-----------------	-----------------------	-----------------



AT5 – slip-free conveyor belts

The positive-driven AT5 conveyor belts enable slip-free traction, even with the smallest pulley diameters of only Ø 18 mm. This means that even conveyor sections with the smallest transfers can now be utilized with a slip-free belt solution.

Thanks to the careful selection of raw materials for direct food contact, the belt solutions offer very good microbial, hydrolysis and chemical resistance.



BOTTOM SIDE: AT5 // 700 mm







Top side	Colour	Features	Quality	Hardness Shore	Profile thickness		Recommended Min. pulley Ø*		k1% static		k1% relaxed		Standard roll		Recommended pretension	Order No.
					mm	inch	mm	inch	N/mm	lbs/inch	N/mm	lbs/inch	m	ft		
 Slightly rough (SR)	UB		PU65A PU80A	72 A 84 A	3,0	0,118	18	0,7	0,35	1,98	0,30	1,68	50	164	1,5% ±0,5%	FBFJG750X3LE
 Smooth matt (SM)	UB	MICRO CLEAN	PU65A PU80A	72 A 84 A	3,0	0,118	18	0,7	0,35	1,98	0,30	1,68	50	164	1,5% ±0,5%	FBFJG750X3L
 Transversal (TGA)	UB	MICRO CLEAN	PU65A PU80A	72 A 84 A	3,8	0,149	28	1,1	0,38	2,11	0,32	1,79	50	164	1,5% ±0,5%	FBFJG750X38A
 Nub top (NP)	UB	MICRO CLEAN	PU65A PU80A	72 A 84 A	3,2	0,125	25	1,0	0,38	2,11	0,32	1,79	50	164	1,5% ±0,5%	FBFJG750X3LC
 Diamond (ID)	UB	MICRO CLEAN	PU65A PU80A	72 A 84 A	3,0	0,118	18	0,7	0,33	1,84	0,28	1,57	50	164	1,5% ±0,5%	FBFJG750X3LD
 Spikes (SP)	UB		PU65A PU80A	72 A 84 A	3,0	0,118	25	1,0	0,35	1,98	0,30	1,68	50	164	1,5% ±0,5%	FBFJG750X3LB

Illustration of drive and guide concepts

The interaction of AT5 (also T5) drive with optimum belt guidance ensures tracking stability and slip-free drive.

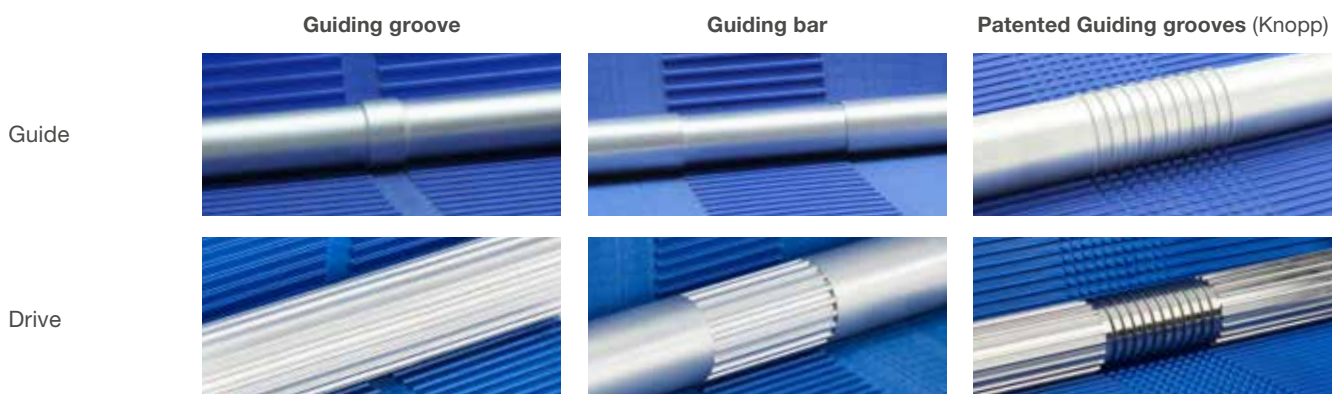

* recommended pulley design: AT5 (optionally also T5 possible)

Elastic conveyor belts up to 750 mm

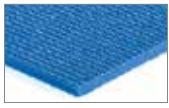

TOP SIDE: SLIGHTLY ROUGH (SR)

Bottom side	Color	Additional features	Quality	Hardness Shore	Profile thickness		Recommended Min. pulley ∅		k1% static		k1% relaxed		Standard roll		Recommended pretension	Order No.		
					mm	inch	mm	inch	N/mm	lbs/inch	N/mm	lbs/inch	m	ft				
Diamond (ID)	UB	MICRO CLEAN UV	PU75A	80 A	1,6	0,062	13	0,52	0,36	2,0	0,30	1,67	50	164	1-5%	FBFJ750X16LI		
		MICRO CLEAN			PU80A	84 A	1,0	0,039	10	0,40	0,24	1,32	0,20	1,12	50	164	1-5%	FBFJ750X10LK
		MICRO CLEAN UV					1,2	0,047	12	0,47	0,29	1,65	0,25	1,40	50	164	1-5%	FBFJ750X12LJ
Fabric impression (FI)	UB		PU80A	84 A	1,0	0,039	10	0,40	0,29	1,65	0,25	1,40	50	164	1-5%	FBFJ750X10L		
					1,2	0,047	10	0,40	0,35	1,98	0,30	1,68	50	164	1-5%	FBFJ750X12L		
					1,6	0,062	15	0,60	0,47	2,64	0,40	2,24	50	164	1-5%	FBFJ750X16L		
					2,0	0,078	20	0,80	0,59	3,29	0,50	2,80	50	164	1-5%	FBFJ750X20L		
	UB	⚡		PU80A	84 A	0,9	0,035	8	0,31	0,33	1,83	0,28	1,56	50	164	1-5%	FBFJ750X09LA	
						1,2	0,047	10	0,40	0,35	1,98	0,30	1,68	50	164	1-5%	FBFJ750X12LA	
						1,6	0,062	15	0,60	0,47	2,64	0,40	2,24	50	164	1-5%	FBFJ750X16LA	







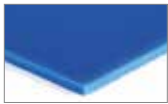







TOP SIDE: SPIKES (SP)

Bottom side	Color	Additional features	Quality	Hardness Shore	Profile thickness		Recommended Min. pulley ∅		k1% static		k1% relaxed		Standard roll		Recommended pretension	Order No.
					mm	inch	mm	inch	N/mm	lbs/inch	N/mm	lbs/inch	m	ft		
Diamond (ID)	UB	UV MICRO CLEAN	PU80	84 A	2,0	0,078	20	0,80	0,53	2,96	0,45	2,52	50	164	1-5%	FBFJ750X20LI
Fabric impression (FI)	UB		PU80A	84 A	1,2	0,047	10	0,40	0,29	1,65	0,25	1,40	50	164	1-5%	FBFJ750X12LG
					2,0	0,078	25	1,00	0,53	2,96	0,45	2,52	50	164	1-5%	FBFJ750X2LG
	UB		PU95A	95 A	2,0	0,078	40	1,57	0,90	5,04	0,77	4,28	50	164	0,5-3%	FBFM750X2LA
					2,5	0,098	45	1,80	1,15	6,44	0,98	5,47	50	164	0,5-3%	FBFM750X25LD
					3,0	0,118	55	2,20	1,40	7,84	1,19	6,66	50	164	0,5-3%	FBFM750X3LA



TOP SIDE: SMOOTH MATT (SM)

Bottom side	Color	Additional features	Quality	Hardness Shore	Profile thickness		Recommended Min. pulley Ø		k1% static		k1% relaxed		Standard roll		Recommended pretension	Order No.
					mm	inch	mm	inch	N/mm	lbs/inch	N/mm	lbs/inch	m	ft		
 Diamond (ID)	UB		PU65A PU75A	72 A 80 A	1,8	0,070	12	0,50	0,30	1,65	0,24	1,33	50	164	1-5%	FBFGI750X18L
					1,8	0,070	15	0,60	0,35	1,93	0,29	1,64	50	164	1-5%	FBFGJ750X18L
 Fabric impression (FI)	UB		PU75A	80 A	1,0	0,039	10	0,40	0,24	1,32	0,20	1,12	50	164	1-5%	FBFI750X10LA
					1,6	0,062	15	0,60	0,38	2,11	0,32	1,79	50	164	1-5%	FBFI750X16LA
					2,0	0,078	20	0,80	0,47	2,64	0,40	2,24	50	164	1-5%	FBFI750X20LA
					3,0	0,118	30	1,20	0,71	3,95	0,60	3,36	50	164	1-5%	FBFI750X30LA
 Fabric impression (FI)	WE		PU80A	84 A	0,9	0,035	8	0,31	0,33	1,83	0,28	1,56	50	164	1-5%	FBFJ750X09LA
					1,2	0,047	10	0,40	0,35	1,98	0,30	1,68	50	164	1-5%	FBFJ750X12LA
 Fabric impression (FI)	UB		PU80A	84 A	1,0	0,039	10	0,40	0,29	1,65	0,25	1,40	50	164	1-5%	FBFJ750X1LD
					1,6	0,062	15	0,60	0,47	2,64	0,40	2,24	50	164	1-5%	FBFJ750X16LD
					2,0	0,078	20	0,80	0,59	3,29	0,50	2,80	50	164	1-5%	FBFJ750X20LD
 Fabric impression (FI)	CB		PU80A SAFE	84 A	1,0	0,039	10	0,40	0,34	1,89	0,29	1,61	50	164	1-5%	FBFJ750X1LA
					1,6	0,062	15	0,60	0,54	3,03	0,46	2,58	50	164	1-5%	FBFJ750X16LE
					2,0	0,078	20	0,80	0,68	3,79	0,58	3,22	50	164	1-5%	FBFJ750X20LE
					3,0	0,118	30	1,20	1,01	5,68	0,86	4,83	50	164	1-5%	FBFJ750X30LE
 Fabric impression (FI)	UB		PU95A	95 A	1,0	0,039	18	0,71	0,50	2,80	0,43	2,38	50	164	0,5-3%	FBFL750X10LA
					1,6	0,062	25	1,00	0,80	4,48	0,68	3,81	50	164	0,5-3%	FBFL750X16LA
					2,0	0,078	35	1,40	1,00	5,60	0,85	4,76	50	164	0,5-3%	FBFL750X20LA
					3,0	0,118	50	2,00	1,50	8,40	1,28	7,14	50	164	0,5-3%	FBFL750X30LA
					4,0	0,157	75	3,00	2,00	11,20	1,70	9,52	30	100	0,5-3%	FBFL750X40LA
 Fabric impression (FI)	WE		PU95A	95 A	1,6	0,062	25	1,00	0,80	4,48	0,68	3,81	50	164	0,5-3%	FBFL750X16WA
					2,0	0,078	35	1,40	1,00	5,60	0,85	4,76	50	164	0,5-3%	FBFL750X20WA
					3,0	0,118	50	2,00	1,50	8,40	1,28	7,14	50	164	0,5-3%	FBFL750X30WA

Elastic conveyor belts up to 750 mm

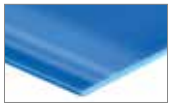

TOP SIDE: SMOOTH GLOSS (SG)

Bottom side	Color	Additional features	Quality	Hardness Shore	Profile thickness		Recommended Min. pulley Ø		k1% static		k1% relaxed		Standard roll		Recommended pretension	Order No.
					mm	inch	mm	inch	N/mm	lbs/inch	N/mm	lbs/inch	m	ft		
Fabric impression (FI)	UB		PU65A	72 A	2,0	0,078	12	0,50	0,24	1,32	0,20	1,12	50	164	1-5%	FBFG750X20LA
					1,6	0,062	15	0,60	0,38	2,11	0,32	1,79	50	164	1-5%	FBFI750X16LD
			PU75A	80 A	2,0	0,078	20	0,80	0,47	2,64	0,40	2,24	50	164	1-5%	FBFI750X20LB
					3,0	0,118	30	1,18	0,71	3,95	0,60	3,36	50	164	1-5%	FBFI750X30LG
Smooth gloss (SG)	UB		PU95A	95 A	2,0	0,078	35	1,40	1,00	5,60	0,85	4,76	50	164	0,5-3%	FBFL750X20LC
					3,0	0,118	50	2,00	1,50	8,40	1,28	7,14	50	164	0,5-3%	FBFL750X30LC
Smooth gloss (SG)	HI		PU95A	95 A	2,0	0,078	35	1,40	1,00	5,60	0,85	4,76	50	164	0,5-3%	FBFL750X20LG
					3,0	0,118	50	2,00	1,50	8,40	1,28	7,14	50	164	0,5-3%	FBFL750X30LG
Diamond (ID)	UB		PU80A	84 A	1,8	0,070	18	0,71	0,47	2,64	0,40	2,24	50	164	1-5%	FBFJ750X18LK
					2,0	0,078	20	0,80	0,53	2,96	0,45	2,52	50	164	1-5%	FBFJ750X2LA
Diamond (ID)	HI		PU95A	95 A	2,0	0,078	35	1,40	0,90	5,04	0,77	4,28	50	164	0,5-3%	FBFM750X2LC
					3,0	0,118	50	2,00	1,40	7,84	1,19	6,66	50	164	0,5-3%	FBFM750X3LC
Diamond (ID)	HI		PU95A	95 A	2,0	0,078	35	1,40	0,90	5,04	0,77	4,28	50	164	0,5-3%	FBFM750X2LD
					3,0	0,118	50	2,00	1,40	7,84	1,19	6,66	50	164	0,5-3%	FBFM750X3LD
Slightly rough (SR)	TR		PU80A	84 A	1,6	0,062	15	0,60	0,47	2,64	0,40	2,24	50	164	1-5%	FBFJ750X16T

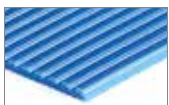

TOP SIDE: LONGITUDINAL GROOVES (LGB)

Bottom side	Color	Additional features	Quality	Hardness Shore	Profile thickness		Recommended Min. pulley Ø		k1% static		k1% relaxed		Standard roll		Recommended pretension	Order No.
					mm	inch	mm	inch	N/mm	lbs/inch	N/mm	lbs/inch	m	ft		
Fabric impression (FI)	UB		PU80A	84 A	1,6	0,062	15	0,60	0,47	2,64	0,40	2,24	50	164	1-5%	FBFJ750X16LK

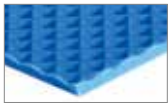

TOP SIDE: INVERTED DIAMOND (ID)

Bottom side	Color	Additional features	Quality	Hardness Shore	Profile thickness		Recommended Min. pulley Ø		k1% static		k1% relaxed		Standard roll		Recommended pretension	Order No.
					mm	inch	mm	inch	N/mm	lbs/inch	N/mm	lbs/inch	m	ft		
Inverted Diamond (ID)	UB		PU65A	72 A	2,2	0,086	15	0,60	0,24	1,32	0,20	1,12	50	164	1-5%	FBFGG750X22L
			PU80A	84 A	2,2	0,086	22	0,87	0,53	2,96	0,45	2,52	50	164	1-5%	FBFJ750X22L0
			PU65A PU80A	72 A 84 A	2,2	0,086	18	0,71	0,36	1,99	0,30	1,70	50	164	1-5%	FBFJG750X22L
Slightly rough (SR)	UB		PU80A	84 A	1,0	0,039	10	0,40	0,24	1,32	0,20	1,12	50	164	1-5%	FBFJ750X10LK
					1,2	0,047	12	0,47	0,29	1,65	0,25	1,40	50	164	1-5%	FBFJ750X12LJ
					1,8	0,070	18	0,71	0,47	2,64	0,40	2,24	50	164	1-5%	FBFJ750X18LJ
Fabric impression (FI)	CB		PU80A	84 A	1,6	0,062	15	0,60	0,54	3,03	0,46	2,58	50	164	1-5%	FBFJ750X16LC
					1,6	0,062	15	0,60	0,41	2,31	0,35	1,96	50	164	1-5%	FBFJ750X16LL
	UB		PU80A	84 A	2,0	0,078	20	0,80	0,53	2,96	0,45	2,52	50	164	1-5%	FBFJ750X2LB
					1,6	0,062	25	1,00	0,70	3,92	0,60	3,33	50	164	0,5-3%	FBFM750X16LH
					2,0	0,078	35	1,38	0,90	5,04	0,77	4,28	50	164	0,5-3%	FBFM750X2LH
					2,5	0,098	40	1,58	1,15	6,44	0,98	5,47	50	164	0,5-3%	FBFM750X25LH
3,0	0,118	50	1,97	1,40	7,84	1,19	6,66	50	164	0,5-3%	FBFM750X3LH					





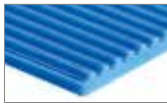

TOP SIDE: NUB TOP (NP)

Bottom side	Color	Additional features	Quality	Hardness Shore	Profile thickness		Recommended Min. pulley Ø		k1% static		k1% relaxed		Standard roll		Recommended pretension	Order No.
					mm	inch	mm	inch	N/mm	lbs/inch	N/mm	lbs/inch	m	ft		
Fabric impression (FI)	UB		PU65A	72 A	2,0	0,078	15	0,60	0,21	1,19	0,18	1,01	50	164	1-5%	FBFG750X2LB
			PU80A	84 A	1,6	0,062	15	0,60	0,41	2,31	0,35	1,96	50	164	1-5%	FBFJ750X16LF
					2,0	0,078	20	0,80	0,53	2,96	0,45	2,52	50	164	1-5%	FBFJ750X20LF

Elastic conveyor belts up to 750 mm





TOP SIDE: TRANSVERSAL GROOVES (TGA)

Bottom side	Color	Additional features	Quality	Hardness Shore	Profile thickness		Recommended Min. pulley Ø		k1% static		k1% relaxed		Standard roll		Recommended pretension	Order No.
					mm	inch	mm	inch	N/mm	lbs/inch	N/mm	lbs/inch	m	ft		
	UB	UV 	PU80	84 A	2,8	0,110	25	1,00	0,62	3,49	0,53	2,97	50	164	1-5%	FBFJ750X28LP
Diamond (ID)					2,5	0,098	20	0,80	0,53	2,96	0,45	2,52	50	164		
	UB		PU95A	95 A	2,5	0,098	40	1,57	0,90	5,04	0,77	4,28	50	164	0,5-3%	FBFM750X25LB
Fabric impression (FI)					3,5	0,137	55	2,17	1,40	7,84	1,19	6,66	50	164		



TOP SIDE: ROUGH IMPRESSION (RI)

Bottom side	Color	Additional features	Quality	Hardness Shore	Profile thickness		Recommended Min. pulley Ø		k1% static		k1% relaxed		Standard roll		Recommended pretension	Order No.
					mm	inch	mm	inch	N/mm	lbs/inch	N/mm	lbs/inch	m	ft		
	UB		PU75	80 A	2,0	0,078	20	0,80	0,35	1,98	0,30	1,68	50	164	1-5%	FBFI750X20LC
Diamond (ID)					3,0	0,118	30	1,20	0,59	3,29	0,50	2,80	50	164		



Conveyor belts for intralogistics

Elastic conveyor belts reduce the costs of system design, as tensioning device can often be avoided. Depending on the goods to be conveyed or the type of conveyor (e.g. accumulation mode, inclined conveyor), a wide variety of belt features are required. With BEHAbelt's new 2C process, two different degrees of hardness can be combined in one belt, for example to provide the transport side with more grip for inclined conveyors.



FDA
EC



TOP SIDE: SMOOTH MATT (SM)

Bottom side	Color	Quality	Hardness Shore	Profile thickness		Recommended Min. pulley \varnothing		k1% static		k1% relaxed		Standard roll		Recommended pretension	Order No.
				mm	inch	mm	inch	N/mm	lbs/inch	N/mm	lbs/inch	m	ft		
 Fabric impression (FI)	SW	PU75A	80 A	1,6	0,062	15	0,60	0,38	2,11	0,32	1,79	50	164	1-5%	FBFI750X16SB

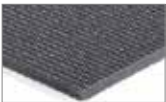

FDA
EC



TOP SIDE: SLIGHTLY ROUGH (SR)

Bottom side	Color	Quality	Hardness Shore	Profile thickness		Recommended Min. pulley \varnothing		k1% static		k1% relaxed		Standard roll		Recommended pretension	Order No.
				mm	inch	mm	inch	N/mm	lbs/inch	N/mm	lbs/inch	m	ft		
 Fabric impression (FI)	SW	PU80A	84 A	1,2	0,047	10	0,40	0,35	1,93	0,30	1,68	50	164	1-5%	FBFJ750X12SB
				1,6	0,062	15	0,60	0,46	2,58	0,40	2,24	50	164	1-5%	FBFJ750X16SB
		PU80A PU65A	84 A 72 A	2,0	0,078	18	0,71	0,45	2,50	0,40	2,24	50	164	1-5%	FBFJG750X2S
		PU55D PU65A	55 D 72 A	1,9	0,074	25	1,0	0,75	4,15	0,60	3,33	50	164	0,5-3%	FBFNG750X19S

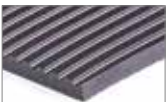

FDA
EC



TOP SIDE: LONGITUDINAL GROOVES (LGB)

Bottom side	Color	Quality	Hardness Shore	Profile thickness		Recommended Min. pulley \varnothing		k1% static		k1% relaxed		Standard roll		Recommended pretension	Order No.
				mm	inch	mm	inch	N/mm	lbs/inch	N/mm	lbs/inch	m	ft		
 Fabric impression (FI)	SW	PU80A PU65A	84 A 72 A	2,2	0,086	18	0,71	0,47	2,64	0,40	2,24	50	164	1-5%	FBFGJ750X22S



FDA
EC



TOP SIDE: ROUGH IMPRESSION (RI)

Bottom side	Color	Quality	Hardness Shore	Profile thickness		Recommended Min. pulley \varnothing		k1% static		k1% relaxed		Standard roll		Recommended pretension	Order No.
				mm	inch	mm	inch	N/mm	lbs/inch	N/mm	lbs/inch	m	ft		
 Diamond (ID)	SW	PU80A	84 A	2,0	0,078	20	0,80	0,44	2,47	0,38	2,10	50	164	1-5%	FBFJ750X20SJ

Machine tapes up to 750 mm



Machine tapes

BEHAbelt complements its versatile belt portfolio with the addition of elastic machine tapes made of TPU. Machine tapes have already been established on the market for many years and are often offered in green/black or blue/black versions with antistatic properties.

In addition to reinforced belt constructions, elastic versions are also used to adapt to the application requirements.

INDUSTRIES / APPLICATIONS

- Packaging and weighing technology
- Intralogistics (mainly distribution belts)
- Enveloping and franking systems
- Printing, paper industry
- Textile industry
- Blue types are suitable for direct contact with food
- Alternative for vertical shaft drives

ADVANTAGES / FEATURES

- Consistent longitudinal flexibility (due to homogeneous belt connection without gluing, design as transverse splice possible)
- Reduced energy consumption due to high longitudinal flexibility and thus also gentle motor and shaft loads
- Excellent bending properties and thus ideally suited for small pulley diameters
- High abrasion resistance and generally good chemical resistance
- Continuous antistatic belt designs offer dissipation properties for antistatic charges on the upper and lower side of the belt.

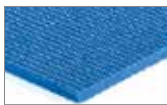

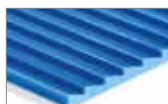

TOP SIDE: SLIGHTLY ROUGH (SR)

Bottom side	Color	Additional features	Quality	Hardness Shore	Profile thickness		Recommended Min. pulley Ø		k1% static		k1% relaxed		Standard roll		Recommended pretension	Order No.		
					mm	inch	mm	inch	N/mm	lbs/inch	N/mm	lbs/inch	m	ft				
Fabric impression (FI)	UB		PU80A	84 A	1,0	0,039	10	0,40	0,29	1,65	0,25	1,40	50	164	1-5%	FBFJ750X10L		
					1,2	0,047	10	0,40	0,35	1,98	0,30	1,68	50	164	1-5%	FBFJ750X12L		
					1,6	0,062	15	0,60	0,47	2,64	0,40	2,24	50	164	1-5%	FBFJ750X16L		
					2,0	0,078	20	0,80	0,59	3,29	0,50	2,80	50	164	1-5%	FBFJ750X20L		
				2C	PU80A PU65A	84 A 72 A	1,8	0,070	15	0,60	0,40	2,24	0,35	1,94	50	164	1-5%	FBFJG750X18L
					PU80A	84 A	0,9	0,035	8	0,31	0,33	1,83	0,28	1,56	50	164	1-5%	FBFJ750X09LA
					PU80A	84 A	1,2	0,047	10	0,40	0,35	1,98	0,30	1,68	50	164	1-5%	FBFJ750X12LA
							1,6	0,062	15	0,60	0,47	2,64	0,40	2,24	50	164	1-5%	FBFJ750X16LA
					PU55D	55 D	1,1	0,039	15	0,60	0,65	3,60	0,50	2,78	50	164	0,5-3%	FBFN750X11L
							1,5	0,059	25	1,0	0,80	4,40	0,65	3,60	50	164	0,5-3%	FBFN750X15L
		2C	PU55D PU65A	55 D 72 A	1,9	0,074	25	1,0	0,75	4,15	0,60	3,33	50	164	0,5-3%	FBFNG750X19L		
Fabric impression (FI)	SW		PU80A	84 A	1,2	0,047	10	0,40	0,35	1,93	0,30	1,68	50	164	1-5%	FBFJ750X12SB		
					1,6	0,062	15	0,60	0,46	2,58	0,40	2,24	50	164	1-5%	FBFJ750X16SB		
					PU80A PU65A	84 A 72 A	2,0	0,078	15	0,60	0,45	2,50	0,40	2,24	50	164	1-5%	FBFJG750X2S
					PU55D	55 D	1,1	0,039	15	0,60	0,65	3,60	0,50	2,78	50	164	0,5-3%	FBFN750X11S
							1,5	0,059	25	1,0	0,80	4,40	0,65	3,60	50	164	0,5-3%	FBFN750X15S
					PU55D PU65A	55 D 72 A	1,9	0,074	25	1,0	0,75	4,15	0,60	3,33	50	164	0,5-3%	FBFNG750X19S



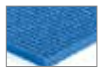

TOP SIDE: SAWTOOTH (EST) // 360 mm

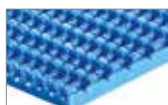
Bottom side	Color	Additional features	Quality	Hardness Shore	Profile thickness		Recommended Min. pulley Ø		k1% static		k1% relaxed		Standard roll		Recommended pretension	Order No.
					mm	inch	mm	inch	N/mm	lbs/inch	N/mm	lbs/inch	m	ft		
 Slightly rough (SR)	UB		PU75A	80 A	3,0	0,118	30	1,00	0,24	1,32	0,20	1,12	25	82	1-5%	FBFI360X30LB
					4,0	0,157	40	1,40	0,47	2,64	0,40	2,24	25	82	1-5%	FBFI360X40LB







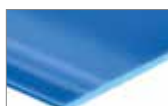

TOP SIDE: SUPERGRIP (ESG) // 360 mm

Bottom side	Color	Additional features	Quality	Hardness Shore	Profile thickness		Recommended Min. pulley Ø		k1% static		k1% relaxed		Standard roll		Recommended pretension	Order No.
					mm	inch	mm	inch	N/mm	lbs/inch	N/mm	lbs/inch	m	ft		
 Slightly rough (SR)	UB		PU75A	80 A	4,0	0,157	40	1,40	0,47	2,64	0,40	2,24	25	82	1-5%	FBFI360X40LA



TOP SIDE: SMOOTH GLOSS (SG) // 140 mm

Bottom side	Color	Additional features	Quality	Hardness Shore	Profile thickness		Recommended Min. pulley Ø		k1% static		k1% relaxed		Standard roll		Recommended pretension	Order No.
					mm	inch	mm	inch	N/mm	lbs/inch	N/mm	lbs/inch	m	ft		
 Smooth gloss (SG)	HI		PU75A	80 A	1,0	0,039	10	0,4	0,24	1,32	0,20	1,12	50	164	1-5%	FBFI150X1LG
					1,6	0,062	15	0,6	0,38	2,11	0,32	1,79	50	164	1-5%	FBFI150X16LG
					2,0	0,078	20	0,8	0,47	2,64	0,40	2,24	50	164	1-5%	FBFI150X2LG
					3,0	0,118	25	1,0	0,71	3,95	0,60	3,36	50	164	1-5%	FBFI150X3LG
					4,0	0,157	35	1,4	0,94	5,27	0,80	4,48	50	164	1-5%	FBFI150X4LG
 Smooth gloss (SG)	UB		PU80A SAFE	84 A	2,0	0,078	20	0,8	0,68	3,79	0,58	3,22	50	164	1-5%	FBFJ150X2LGM
					3,0	0,118	30	1,2	1,01	5,68	0,86	4,83	50	164	1-5%	FBFJ150X3LGM
 Smooth gloss (SG)	OR		PU80A	84 A	1,6	0,062	15	0,6	0,47	2,64	0,40	2,24	30	100	1-5%	FBFJ150X160G
					2,4	0,094	25	1,0	0,71	3,95	0,60	3,36	30	100	1-5%	FBFJ150X240G
					3,2	0,125	30	1,2	0,94	5,27	0,80	4,48	30	100	1-5%	FBFJ150X320G
 Smooth gloss (SG)	GR		PU85A	88 A	1,0	0,039	15	0,6	0,35	1,98	0,30	1,68	50	164	1-5%	FBFK150X1GG
					1,6	0,062	20	0,8	0,56	3,16	0,48	2,69	50	164	1-5%	FBFK150X16GG
					2,0	0,078	30	1,2	0,71	3,95	0,60	3,36	50	164	1-5%	FBFK150X2GG
					3,0	0,118	35	1,4	1,06	5,93	0,90	5,04	50	164	1-5%	FBFK150X3GG
					4,0	0,157	45	1,8	1,41	7,91	1,20	6,72	50	164	1-5%	FBFK150X4GG

Didn't find your belt?

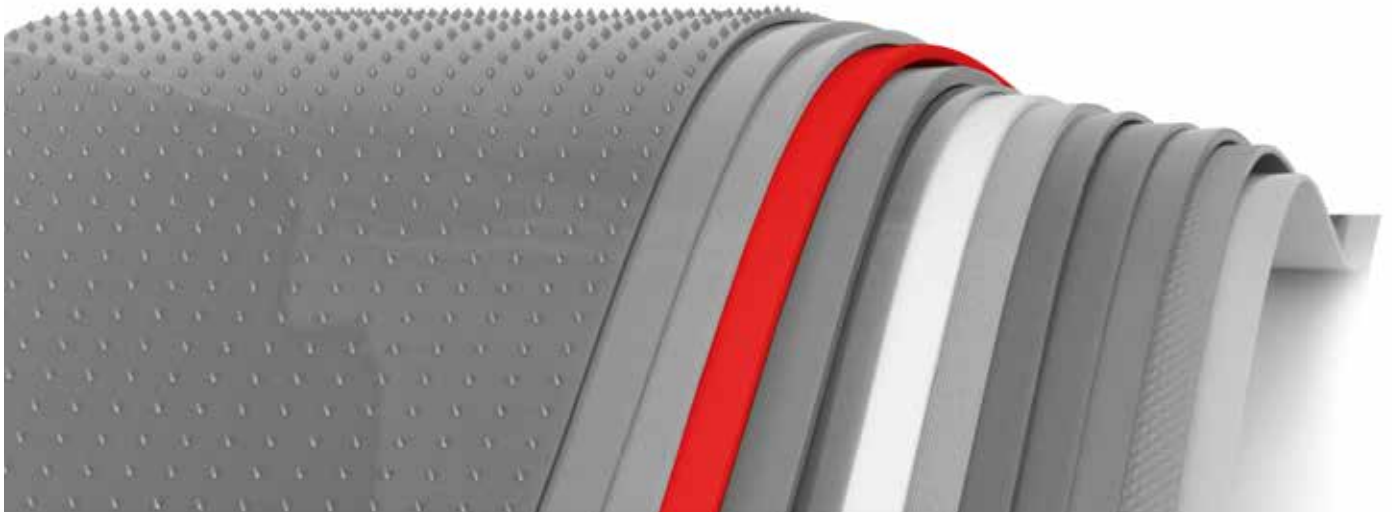

no minimum order quantities

according to your specifications

in only 4-8 weeks

BEHAbelt offers you the exclusive and fast realisation of your desired conveyor belt!

If a standard belt does not meet the requirements of your application, BEHAbelt offers you the unique opportunity to develop a customer-specific product. According to your specifications and your design!

Tell us your application!

We will be happy to evaluate the possibilities for optimising your application with regards to conveyor belt design. In particular, the 2-component production enables a multitude of combinations of structures, hardnesses, belt properties and colours.

FAST REALISATION (4-8 WEEKS)

- Many years of experience, in-house manufacturing of tooling, individual consulting
- Development of customer-specific conveyor belts
- Specially adapted to your application
- Especially according to your design

ECONOMIC ADVANTAGES

- Exclusivity / securing the After Sales Market
- Material combination
- Optimisation of your application through the perfect belt
- Improved service life and functionality
- Appropriate welding technology

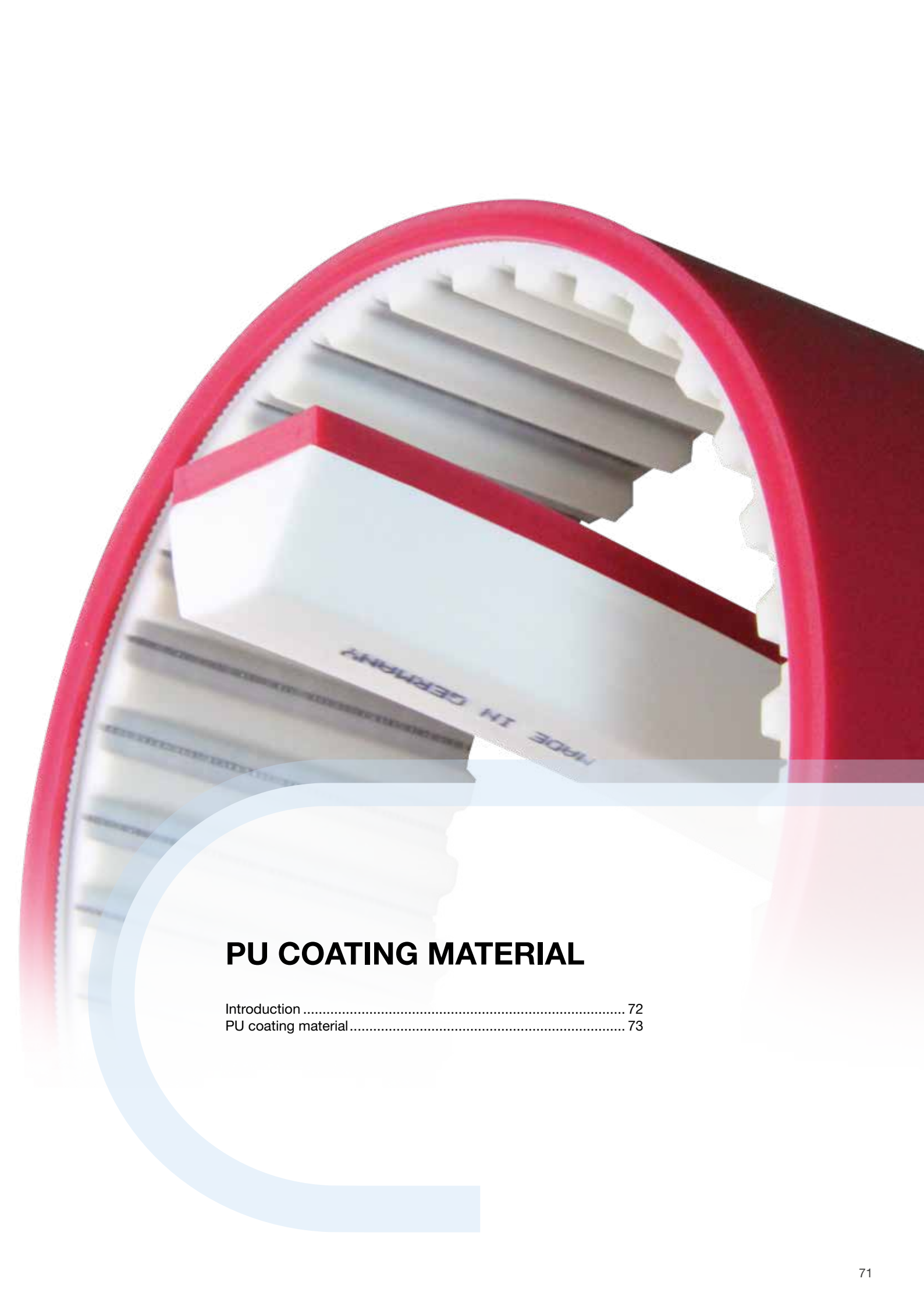

PU COATING MATERIAL

Introduction	72
PU coating material	73

PU coating material

Our product group of PU coating materials is based on the careful selection of high-quality raw materials, which have been successfully tested and used in the field for a long time. We supply coating material in rolls from 140 - 750 mm with a coating thickness of 1 - 4 mm and an available hardness range from Shore 45A to 95A for your individual application.

The extensive portfolio offers you a multitude of application optimizations and processing advantages compared to conventional coating materials such as rubber or PVC. PU coatings are the optimal combination to create high-quality and robust products, especially in connections with PU base belts; a product from a single casting.

Optimization of your application

Below you will find an overview of optimization potentials that can be achieved through coatings. We would be pleased to advise you comprehensively.

- High abrasion resistance
- Improved flexural fatigue strength
- Optimum shock absorption
- Better adhesion of the coating on the base belt (coating detachment)
- Very good grip
- Optimisation of dust operation
- Variety of surface structures for optimum contact conditions and release requirements
- Excellent chemical resistance

Selectable special features

Food industry, logistics industry etc.; the requirements could not be more varied. Within our manufacturing process we can easily realize special properties for the coatings.



Antistatic design



Resistant to hydrolysis and cleaning



FDA/EC conformity for food industry



Metal and X-ray detectable







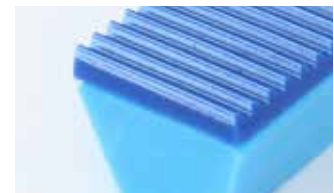



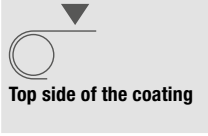



Fabrication benefits

- Uniform stable melting phase
- Very good weldability with all PU types
- Direct processing on the PU base belt without adhesive
- Homogeneous connection with the PU base belt
- Weldable coating joint
- Good further mechanical processing possible







PU COATING MATERIAL // 140 mm

 Top side of the coating	Color	Features	Quality	Hardness	Profile thickness		Weight per m ²	max. belt width		Impact on min. pulley \varnothing		Standard roll		Order No.
				Shore	mm	inch	approx. kg	mm	inch	mm	inch	m	ft	
 Smooth gloss (SG)	TR	 PU grip	PU40A	45 A	2,0	0,078	2,4	140	5,5	+10	+0,4	50	164	FBFD140X2TG
					3,0	0,118	3,6	140	5,5	+15	+0,6	50	164	FBFD140X3TG
					4,0	0,157	4,8	140	5,5	+20	+0,8	50	164	FBFD140X4TG
	TR	PU60A	65 A	1,6	0,062	1,9	140	5,5	+10	+0,4	50	164	FBFF150X16TG	
				2,0	0,078	2,4	140	5,5	+15	+0,6	50	164	FBFF150X2TG	
				3,0	0,118	3,6	140	5,5	+20	+0,8	50	164	FBFF150X3TG	
				4,0	0,157	4,8	140	5,5	+25	+1,0	50	164	FBFF150X4TG	
	TR	 PU65A	72 A	1,0	0,039	1,2	140	5,5	+10	+0,4	50	164	FBFG150X1TG	
				1,6	0,062	1,9	140	5,5	+12	+0,5	50	164	FBFG150X16TG	
				2,0	0,078	2,4	140	5,5	+15	+0,7	50	164	FBFG150X2TG	
				3,0	0,118	3,6	140	5,5	+25	+1,0	50	164	FBFG150X3TG	
				4,0	0,157	4,8	140	5,5	+35	+1,4	50	164	FBFG150X4TG	
TR	 PU75A	80 A	1,0	0,039	1,2	140	5,5	+10	+0,5	50	164	FBFI150X1TG		
			1,6	0,062	1,9	140	5,5	+15	+0,6	50	164	FBFI150X16TG		
			2,0	0,078	2,4	140	5,5	+20	+0,8	50	164	FBFI150X2TG		
			3,0	0,118	3,6	140	5,5	+30	+1,2	50	164	FBFI150X3TG		
			4,0	0,157	4,8	140	5,5	+40	+1,6	50	164	FBFI150X4TG		
TR	 PU85A	88 A	1,0	0,039	1,2	140	5,5	+15	+0,6	50	164	FBFK150X1TG		
			1,6	0,062	1,9	140	5,5	+20	+0,8	50	164	FBFK150X16TG		
			2,0	0,078	2,4	140	5,5	+25	+1,0	50	164	FBFK150X2TG		
			3,0	0,118	3,6	140	5,5	+35	+1,4	50	164	FBFK150X3TG		
			4,0	0,157	4,8	140	5,5	+45	+1,8	50	164	FBFK150X4TG		
 PUtex / smooth (S)	RO	 PU tex  *	PU60A	65 A	1,6	0,062	1,9	140	5,5	+10	+0,4	50	164	FBFF150X16BM
					2,0	0,078	2,4	140	5,5	+15	+0,6	50	164	FBFF150X2BM
					3,0	0,118	3,6	140	5,5	+20	+0,8	50	164	FBFF150X3BM
					4,0	0,157	4,8	140	5,5	+25	+1,0	50	164	FBFF150X4BM
 Longitudinal (LGA)	TR	 PU65A	72 A	2,6	0,102	2,5	140	5,5	+22	+0,9	50	164	FBFG150X26TW	
				3,0	0,118	3,0	140	5,5	+25	+1,0	50	164	FBFG150X3TW	
 Longitudinal (LGC)	WE	 PU80A	84 A	3,0	0,118	2,4	140	5,5	+30	+1,2	50	164	FBFJ140X3WG	







* Limited suitability EC

PU coating material up to 360 mm and 750 mm

PU COATING MATERIAL // 360 mm

 Top side of the coating	Color	Features	Quality	Hardness Shore	Profile thickness		Weight per m ² approx. kg	max. belt width		Impact on min. pulley \varnothing		Standard roll		Order No.
					mm	inch		mm	inch	mm	inch	m	ft	
 Supergrip (ESG)	UB		PU75A	80 A	4,0	0,157	3,6	360	14,0	+40	+1,6	25	82	FBFI360X40LA
 Sawtooth (EST)	UB		PU75A	80 A	3,0	0,118	2,4	360	14,0	+30	+1,2	25	82	FBFI360X30LB
					4,0	0,157	3,6	360	14,0	+40	+1,6	25	82	FBFI360X40LB

PU COATING MATERIAL // 750 mm

 Top side of the coating	Color	Features	Quality	Hardness Shore	Profile thickness		Weight per m ² approx. kg	max. belt width		Impact on min. pulley \varnothing		Standard roll		Order No.
					mm	inch		mm	inch	mm	inch	m	ft	
 Nub top (NP)	UB		PU65A	72 A	2,0	0,078	2,4	750	29,5	+15	+0,6	50	164	FBFG750X2LB
 Rough impression (RI)	UB		PU65A	72 A	2,0	0,078	2,4	750	29,5	+15	+0,6	50	164	FBFG750X20LB
					3,0	0,118	3,6	750	29,5	+25	+1,0	50	164	FBFG750X30LA
 Smooth gloss (SG)	UB		PU75A	80 A	4,0	0,157	4,8	750	29,5	+40	+1,6	50	164	FBFI750X40LC
 Spikes (SP)	UB		PU80A	84 A	1,2	0,047	1,5	750	29,5	+10	+0,4	50	164	FBFJ750X12LG
 Transversal (TGA)	UB		PU80A	84 A	2,5	0,098	2,4	750	29,5	+20	+0,8	50	164	FBFJ750X25LL
 Longitudinal (LGB)	UB		PU80A	84 A	1,6	0,062	1,9	750	29,5	+15	+0,6	50	164	FBFJ750X16LK
 Slightly rough (SR)	UB		PU80A	84 A	1,2	0,047	1,4	750	29,5	+10	+0,4	50	164	FBFJ750X12L
 Diamond (ID)	UB		PU80A	84 A	1,6	0,062	1,9	750	29,5	+15	+0,6	50	164	FBFJ750X16LL
 Smooth matt (SM)	CB		PU80A SAFE	84 A	1,6	0,062	2,2	750	29,5	+15	+0,6	50	164	FBFJ750X16LE
	UB		PU95A	95 A	1,6	0,062	1,9	750	29,5	+25	+1,0	50	164	FBFL750X16LA

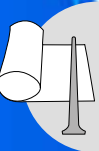

WELDABLE ACCESSORIES FOR CONVEYOR BELTS

V-guides / Special V-guides	76
Belt edges	80
Cleats	81
Sidewalls	84
PU sheet material	86

Weldable accessories for conveyor belts

There is a wide field of applications for synthetic conveyor belts. Depending on the industry, the products to be conveyed and the given machinery design, conveyor belts not only have to be fabricated to specific dimensions (length and width), often they are also equipped with cleats, sidewalls or tracking elements. BEHAbelt offers a wide range of flat belt accessories, homogeneously extruded from PU in different Shore hardness grades.

Our flat belt accessories consist of the same raw materials as the conveyor belts to ensure the best possible weldability and a long service life in the application.

Of course, the BEHAbelt flat belt accessories are also available with FDA/EC/USDA compliance on request and can further be offered with special features such as detectable, UV-C resistance or hydrolysis resistance.



Notched V-guides or guide profiles

- Frequently used as guiding profile on the running side to support the tracking of e.g. long and/or narrow conveyor belts, also to absorb transversal forces during lateral product feeding.
- Can be applied on the conveying side instead of corrugated sidewalls.
- Many versions available.



Belt edges

- For the stabilisation and guidance of curved belts. Belt edges are usually applied by sewing or glued.
- Many versions available.
- Customer-specific special profiles possible.



Cleats / PU sheet material

- For carrying single or bulk goods on inclined conveyors.
- 3 versions available
 - flat foot
 - narrow foot
 - Sheet material (up to 8mm thick) without foot



Corrugated sidewalls

- Usually in combination with cleats on inclined or declined conveyor belts to prevent products from dropping sideways.
- 2 versions available
 - with foot
 - PUflex flat stock material without foot

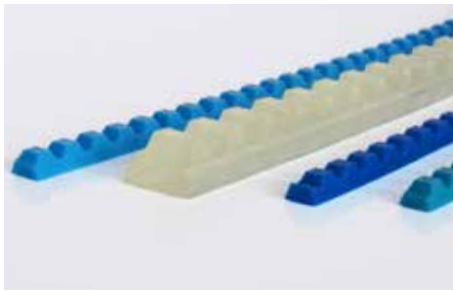

V-guides / Guiding profiles

- All profiles are made from PU and can be supplied in various colours upon request.
- Approved for use in food contact applications according to FDA/EC (PU70A).
- **Excellent adhesion with PU belts** by means of hot air or high frequency welding.

PU60A transparent V-guide smooth

BEST SUITABLE FOR BELT QUALITY **PU80A**



Order No.		Profile dimension	Standard Roll		Recommended Min. pulley \varnothing			
unnotched	notched		mm	m	ft	unnotched		notched
						mm	inch	mm
FBKF6YTG	FBKF6YTG D	6 x 4 (Y)	150	492	25,0	1,0	20,0	0,8
FBKF8MTG	FBKF8MTG D	8 x 5 (M)	150	492	30,0	1,2	25,0	1,0
FBKF10ZTG	FBKF10ZTG D	10 x 6 (Z)	150	492	40,0	1,6	30,0	1,2
FBKF13ATG	FBKF13ATG D	13 x 8 (A)	150	492	60,0	2,4	45,0	1,8
FBKF17BTG	FBKF17BTG D	17 x 11 (B)	100	328	80,0	3,2	60,0	2,4
FBKF22CTG	FBKF22CTG D	22 x 14 (C)	50	164	110,0	4,4	85,0	3,3

approx. 65° Shore A

Coeff. of friction μ : Steel: approx. 0,85 | PE: approx. 0,50 | HDPE: approx. 0,45

PU60A sky blue V-guide smooth

BEST SUITABLE FOR BELT QUALITY **PU80A**

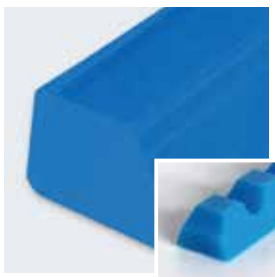

Order No.		Profile dimension	Standard Roll		Recommended Min. pulley \varnothing			
unnotched	notched		mm	m	ft	unnotched		notched
						mm	inch	mm
FBKF6YLG	FBKF6YLG D	6 x 4 (Y)	150	492	25,0	1,0	20,0	0,8
FBKF8MLG	FBKF8MLG D	8 x 5 (M)	150	492	30,0	1,2	25,0	1,0
FBKF10ZLG	FBKF10ZLG D	10 x 6 (Z)	150	492	40,0	1,6	30,0	1,2
FBKF13ALG	FBKF13ALG D	13 x 8 (A)	150	492	60,0	2,4	45,0	1,8
FBKF17BLG	FBKF17BLG D	17 x 11 (B)	100	328	80,0	3,2	60,0	2,4
FBKF22CLG	FBKF22CLG D	22 x 14 (C)	50	164	110,0	4,4	85,0	3,3

approx. 65° Shore A

Coeff. of friction μ : Steel: approx. 0,85 | PE: approx. 0,50 | HDPE: approx. 0,45

PU60A ultramarine blue V-guide smooth

BEST SUITABLE FOR BELT QUALITY **PU80A**

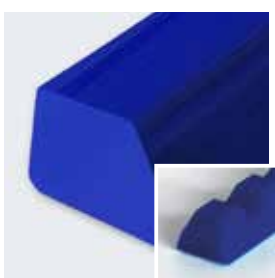

Order No.		Profile dimension	Standard Roll		Recommended Min. pulley \varnothing			
unnotched	notched		mm	m	ft	unnotched		notched
						mm	inch	mm
FBKF6YLGE	FBKF6YLGF	6 x 4 (Y)	150	492	25,0	1,0	20,0	0,8
FBKF8MLGE	FBKF8MLGF	8 x 5 (M)	150	492	30,0	1,2	25,0	1,0
FBKF10ZLGE	FBKF10ZLGF	10 x 6 (Z)	150	492	40,0	1,6	30,0	1,2
FBKF13ALGE	FBKF13ALGF	13 x 8 (A)	150	492	60,0	2,4	45,0	1,8
FBKF17BLGE	FBKF17BLGF	17 x 11 (B)	100	328	80,0	3,2	60,0	2,4
FBKF22CLGE	FBKF22CLGF	22 x 14 (C)	50	164	110,0	4,4	85,0	3,3

approx. 65° Shore A

Coeff. of friction μ : Steel: approx. 0,85 | PE: approx. 0,50 | HDPE: approx. 0,45

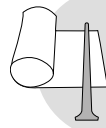

PU65A transparent V-guide smooth

BEST SUITABLE FOR BELT QUALITY

PU75A/PU95A

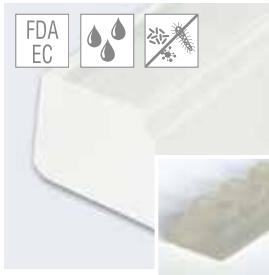

Order No.		Profile dimension	Standard Roll		Recommended Min. pulley \varnothing			
unnotched	notched	mm	m	ft	unnotched		notched	
					mm	inch	mm	inch
FBKG5X3TG	–	5 x 3	150	492	20	0,8	–	–
FBKG6YTG	FBKG6YTGA	6 x 4 (Y)	150	492	30	1,2	25	1,0
FBKG8MTG	FBKG8MTGA	8 x 5 (M)	150	492	35	1,4	28	1,1
FBKG10ZTG	FBKG10ZTGA	10 x 6 (Z)	150	492	40	1,6	30	1,2
FBKG13ATG	FBKG13ATGA	13 x 8 (A)	150	492	65	2,6	40	1,6
FBKG17BTG	FBKG17BTGA	17 x 11 (B)	100	328	85	3,4	55	2,2
FBKG22CTG	FBKG22CTGA	22 x 14 (C)	50	164	120	4,0	90	3,5

approx. 72° Shore A

Coeff. of friction μ : Steel: approx. 0,80 | PE: approx. 0,45 | HDPE: approx. 0,40 | FDA/EC/USDA compliant

PU65A ultramarine blue V-guide smooth

BEST SUITABLE FOR BELT QUALITY

PU75A/PU95A

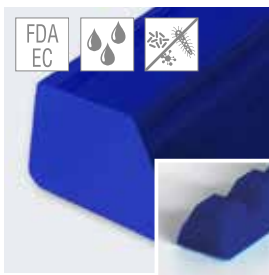

Order No.		Profile dimension	Standard Roll		Recommended Min. pulley \varnothing			
unnotched	notched	mm	m	ft	unnotched		notched	
					mm	inch	mm	inch
FBKG5X3LG	–	5 x 3	150	492	20	0,8	–	–
FBKG6YLG	FBKG6YLGA	6 x 4 (Y)	150	492	30	1,2	25	1,0
FBKG8MLG	FBKG8MLGA	8 x 5 (M)	150	492	35	1,4	28	1,1
FBKG10ZLG	FBKG10ZLGA	10 x 6 (Z)	150	492	40	1,6	30	1,2
FBKG13ALG	FBKG13ALGA	13 x 8 (A)	150	492	65	2,6	40	1,6
FBKG17BLG	FBKG17BLGA	17 x 11 (B)	100	328	85	3,4	55	2,2
FBKG22CLG	FBKG22CLGA	22 x 14 (C)	50	164	120	4,0	90	3,5

approx. 72° Shore A

Coeff. of friction μ : Steel: approx. 0,80 | PE: approx. 0,45 | HDPE: approx. 0,40 | FDA/EC/USDA compliant

PU70A transparent V-guide smooth

BEST SUITABLE FOR BELT QUALITY

PU80A



Order No.		Profile dimension	Standard Roll		Recommended Min. pulley \varnothing			
unnotched	notched	mm	m	ft	unnotched		notched	
					mm	inch	mm	inch
FBKH5X3TG	–	5 x 3	150	492	25,0	1,0	–	–
FBKH6YTG	FBKH6YTGD	6 x 4 (Y)	150	492	30,0	1,2	25,0	1,0
FBKH8MTG	FBKH8MTGD	8 x 5 (M)	150	492	35,0	1,4	30,0	1,2
FBKH10ZTG	FBKH10ZTGD	10 x 6 (Z)	150	492	45,0	1,8	35,0	1,4
FBKH13ATG	FBKH13ATGD	13 x 8 (A)	150	492	70,0	2,8	55,0	2,1
FBKH17BTG	FBKH17BTGD	17 x 11 (B)	100	328	90,0	3,6	70,0	2,8
FBKH22CTG	FBKH22CTGD	22 x 14 (C)	50	164	130,0	5,2	100,0	3,9

approx. 76° Shore A

Coeff. of friction μ : Steel: approx. 0,75 | PE: approx. 0,40 | HDPE: approx. 0,35

FDA/EC/USDA compliant (Limited suitability EC)

PU70A sky blue V-guide smooth

BEST SUITABLE FOR BELT QUALITY **PU80A**

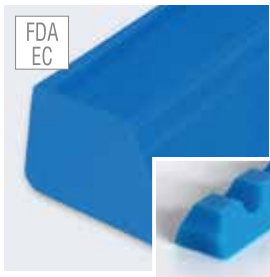

Order No.		Profile dimension mm	Standard Roll		Recommended Min. pulley \varnothing			
unnotched	notched		m	ft	unnotched		notched	
					mm	inch	mm	inch
FBKH6YLG	FBKH6YLGA	6 x 4 (Y)	150	492	30,0	1,2	25,0	1,0
FBKH8MLG	FBKH8MLGA	8 x 5 (M)	150	492	35,0	1,4	30,0	1,2
FBKH10ZLG	FBKH10ZLGA	10 x 6 (Z)	150	492	45,0	1,8	35,0	1,4
FBKH13ALG	FBKH13ALGA	13 x 8 (A)	150	492	70,0	2,8	55,0	2,1
FBKH17BLG	FBKH17BLGA	17 x 11 (B)	100	328	90,0	3,6	70,0	2,8
FBKH22CLG	FBKH22CLGA	22 x 14 (C)	50	164	130,0	5,2	100,0	3,9

Coeff. of friction μ : Steel: approx. 0,75 | PE: approx. 0,40 | HDPE: approx. 0,35

approx. 76° Shore A

FDA/EC/USDA compliant (limited suitability EC)

PU70A ultramarine blue V-guide smooth

BEST SUITABLE FOR BELT QUALITY **PU80A**

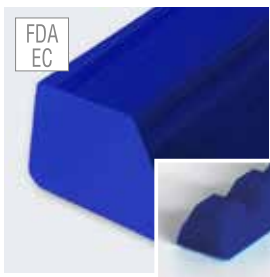

Order No.		Profile dimension mm	Standard Roll		Recommended Min. pulley \varnothing			
unnotched	notched		m	ft	unnotched		notched	
					mm	inch	mm	inch
FBKH5X3LGB	–	5 x 3	250	820	25,0	1,0	–	–
FBKH6YLGB	FBKH6YLGC	6 x 4 (Y)	150	492	30,0	1,2	25,0	1,0
FBKH8MLGB	FBKH8MLGC	8 x 5 (M)	150	492	35,0	1,4	30,0	1,2
FBKH10ZLGB	FBKH10ZLGC	10 x 6 (Z)	150	492	45,0	1,8	35,0	1,4
FBKH13ALGB	FBKH13ALGC	13 x 8 (A)	150	492	70,0	2,8	55,0	2,1
FBKH17BLGB	FBKH17BLGC	17 x 11 (B)	100	328	90,0	3,6	70,0	2,8
FBKH22CLGB	FBKH22CLGC	22 x 14 (C)	50	164	130,0	5,2	100,0	3,9

Coeff. of friction μ : Steel: approx. 0,75 | PE: approx. 0,40 | HDPE: approx. 0,35

approx. 76° Shore A

FDA/EC/USDA compliant (Limited suitability EC)

PU70A safe capri blue V-guide smooth

BEST SUITABLE FOR BELT QUALITY **PU80A**

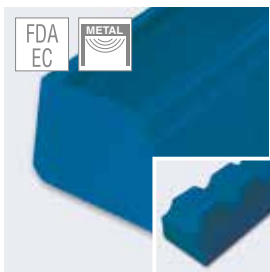

Order No.		Profile dimension mm	Standard Roll		Recommended Min. pulley \varnothing			
unnotched	notched		m	ft	unnotched		notched	
					mm	inch	mm	inch
FBKF6YLGA	FBKF6YLG	6 x 4 (Y)	150	492	30,0	1,2	25,0	1,0
FBKF8MLGA	FBKF8MLG	8 x 5 (M)	150	492	35,0	1,4	30,0	1,2
FBKF10ZLGA	FBKF10ZLG	10 x 6 (Z)	150	492	45,0	1,8	35,0	1,4
FBKF13ALGA	FBKF13ALG	13 x 8 (A)	150	492	70,0	2,8	55,0	2,1
FBKF17BLGA	FBKF17BLG	17 x 11 (B)	100	328	90,0	3,6	70,0	2,8
FBKF22CLGA	FBKF22CLG	22 x 14 (C)	50	164	130,0	5,2	100,0	3,9

Coeff. of friction μ : Steel: approx. 0,75 | PE: approx. 0,40 | HDPE: approx. 0,35 |

approx. 76° Shore A

FDA/EC/USDA compliant (Limited suitability EC)

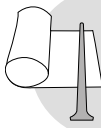

PU70A transparent special V-guide smooth 8x3,2 mm



Order No.	Profile dimension	Standard Roll		Recommended Min. pulley \varnothing	
		mm	m	ft	mm
FBKH8X32TG	8 x 3,2	150	492	25,0	1,0

BEST SUITABLE FOR BELT QUALITY **PU80A**

Coeff. of friction μ : Steel: approx. 0,75 | PE: approx. 0,40 | HDPE: approx. 0,35

FDA/EC/USDA compliant (Limited suitability EC)

approx. 76° Shore A

PU80A transparent special V-guide smooth 13x6,5 mm / 10x5 mm



Order No.	Profile dimension	Standard Roll		Recommended Min. pulley \varnothing	
		mm	m	ft	mm
FBKJ13X65TG	13 x 6,5	200	656	60,0	2,4
FBKJ10X5TG	10 x 5,0	150	492	45,0	1,8

BEST SUITABLE FOR BELT QUALITY **PU80A**

Coeff. of friction μ : Steel: approx. 0,65 | PE: approx. 0,35 | HDPE: approx. 0,30 | **FDA/EC/USDA compliant**

approx. 84° Shore A

PU65A transparent special V-guide smooth 9x4,5 mm



Order No.	Profile dimension	Standard Roll		Recommended Min. pulley \varnothing	
		mm	m	ft	mm
FBSG9X45TG	9 x 4,5	150	492	30	1,18

BEST SUITABLE FOR BELT QUALITY **PU75A/PU95A**

Special guiding profile for round belt grooves of roller conveyors

Coeff. of friction μ : Steel: approx. 0,80 | PE: approx. 0,45 | HDPE: approx. 0,40 | **FDA/EC/USDA compliant**

approx. 72° Shore A



PU60A transparent 19 x 8 mm

BEST SUITABLE FOR BELT QUALITY **PU80A**



Order No.	Profile dimension mm	Standard Roll		Recommended Min. pulley \varnothing	
		m	ft	mm	inch
FBSF19X8TB	19 x 8	100	328	60	2,4

approx. 65° Shore A

Coeff. of friction μ : Steel: approx. 0,85 | PE: approx. 0,50 | HDPE: approx. 0,45

PU75A sky blue, PU85A ultramarine blue, 22 x 8 mm

BEST SUITABLE FOR BELT QUALITY **PU75A/PU95A**

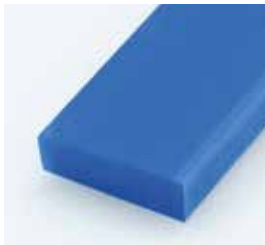

Order No.	Color	Profile dimension mm	Standard Roll		Recommended Min. pulley \varnothing	
			m	ft	mm	inch
FBFI22X8LG	sky blue	22 x 8	50	164	80	3,1
FBFK22X8LG	ultramarine blue	22 x 8	50	164	95	3,7

PU75A, approx. 80° Shore A

Coeff. of friction μ : Steel: approx. 0,70 | PE: approx. 0,40 | HDPE: approx. 0,35

PU85A, approx. 88° Shore A

Coeff. of friction μ : Steel: approx. 0,60 | PE: approx. 0,35 | HDPE: approx. 0,30

PU80A ultramarine blue 16 x 8 mm

BEST SUITABLE FOR BELT QUALITY **PU80A**

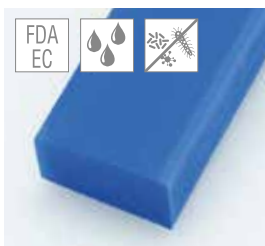

Order No.	Profile dimension mm	Standard Roll		Recommended Min. pulley \varnothing	
		m	ft	mm	inch
FBFJ16X8LG	16 x 8	50	164	80	3,15

approx. 84° Shore A

Coeff. of friction μ : Steel: approx. 0,85 | PE: approx. 0,50 | HDPE: approx. 0,45

PU75A ultramarine blue guiding profile smooth 8 x 8 mm

BEST SUITABLE FOR BELT QUALITY **PU75A/PU95A**



Order No.	Profile dimension mm	Standard Roll		Recommended Min. pulley \varnothing	
		m	ft	mm	inch
FBFI8X8LG	8 x 8	50	164	75	2,95

approx. 80° Shore A

Coeff. of friction μ : Steel: approx. 0,70 | PE: approx. 0,40 | HDPE: approx. 0,35 | FDA/EC/USDA compliant

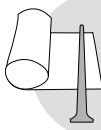

PU70A transparent half round smooth

BEST SUITABLE FOR BELT QUALITY

PU80A



FDA
EC

Order No.	Profile dimension	Standard Roll		Recommended Min. pulley \varnothing	
	mm	m	ft	mm	inch
FBIH8X4TG	8 x 4	40	132	30	1,2
FBIH10X5TG	10 x 5	30	100	35	1,4
FBIH12X6TG	12 x 6	40	132	45	1,8
FBIH15X7TG	15 x 7	30	100	60	2,4
FBIH18X9TG	18 x 9	40	132	80	3,2

approx. 76° Shore A

Coeff. of friction μ : Steel: approx. 0,70 | PE: approx. 0,40 | HDPE: approx. 0,35 | FDA/EC/USDA compliant

PU75A sky blue guiding profile round smooth \varnothing 5x9 mm

BEST SUITABLE FOR BELT QUALITY

PU75A/PU95A

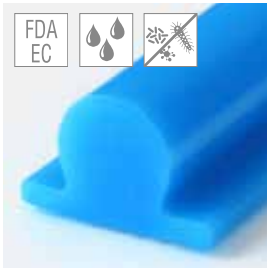

FDA
EC

Order No.	Profile dimension	Standard Roll		Recommended Min. pulley \varnothing	
	mm	m	ft	mm	inch
FBTI5X5X9HI	\varnothing 5 x 5,5 x 9	90	295	40,0	1,6

approx. 80° Shore A

Also ideal as a weld-on profile for clamping the aprons in the fastening rail

Coeff. of friction μ : Steel: approx. 0,70 | PE: approx. 0,40 | HDPE: approx. 0,35 | FDA/EC/USDA compliant

PU75A transparent special flat-guide smooth 10x2 mm

BEST SUITABLE FOR BELT QUALITY

PU75A/PU95A



FDA
EC

Order No.	Profile dimension	Cross section	Standard Roll		Recommended Min. pulley \varnothing	
	mm	cm ²	m	ft	mm	inch
FBFI10X2TG	10 x 2	0,2	200	656	15	0,59

approx. 80° Shore A

Coeff. of friction μ : Steel: approx. 0,70 | PE: approx. 0,40 | HDPE: approx. 0,35 | FDA/EC/USDA compliant

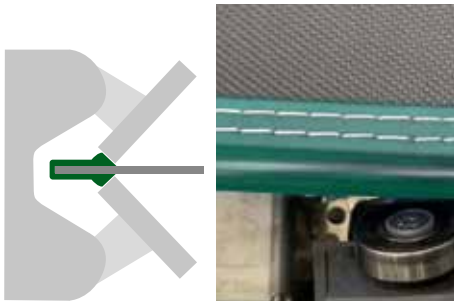

Belt edges / belt curve guiding profiles

So-called edge profiles are used to stabilise and guide curved belts. The profiles are usually sewn or glued onto the curved belt. By means of the profile bead, the curved belt can be supported during operation.

Advantages: High tear resistance, high flexibility, low abrasion, individual colouring

PU80A Belt edge 13x26 mm, transparent

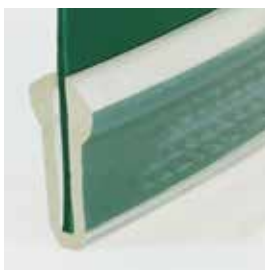

approx. 80° Shore A

Order No.	Profile dimension mm	Cross section cm ²	approx. Weight kg/100 m	Standard Roll		Recommended Min.-pulley \varnothing	
				m	ft	mm	inch
FBSP80A13X26	13 x 26	1,49	17,9	30,0	100,0	+100	+4,0

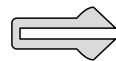

PU65A, 75A, 85A Belt edge 14x28 mm, emerald green

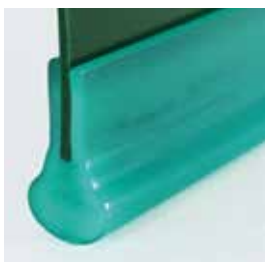

approx. 72°, 80°, 88° Shore A

Order No.	Profile dimension mm	Cross section cm ²	approx. Weight kg/100 m	Standard Roll		Recommended Min.-pulley \varnothing	
				m	ft	mm	inch
FBGK65A14X28	14 x 28	1,9	22,8	30,0	100,0	+80	+3,2
FBSP75A14X28	14 x 28	1,9	22,8	30,0	100,0	+100	+4,0
FBSP85A14X28	14 x 28	1,9	22,8	30,0	100,0	+140	+5,5

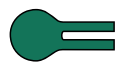

PU80A Belt edge 8,8x18 mm, emerald green

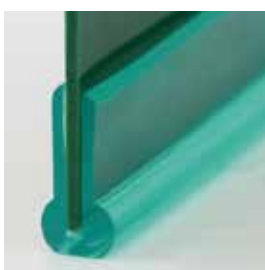

approx. 84° Shore A

Order No.	Profile dimension mm	Cross section cm ²	approx. Weight kg/100 m	Standard Roll		Recommended Min.-pulley \varnothing	
				m	ft	mm	inch
FBSP80A88X18	8,8 x 18	0,62	7,4	30,0	100,0	+65	+2,6

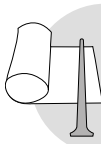

PU80A Belt edge 3,5 x 37 mm, emerald green

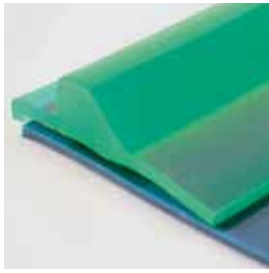

approx. 84° Shore A

Order No.	Profile dimension mm	Cross section cm ²	approx. Weight kg/100 m	Standard Roll		Recommended Min.-pulley Ø	
				m	ft	mm	inch
FBSP80A35X37	3,5 x 37	1,2	14,3	30,0	100,0	+60	+2,4



PU65A Belt edge 10 x 35 mm, transparent

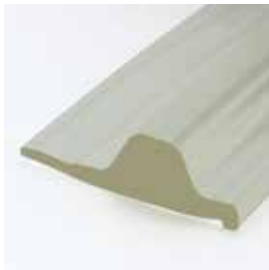

approx. 72° Shore A

Order No.	Profile dimension mm	Cross section cm ²	approx. Weight kg/100 m	Standard Roll		Recommended Min.-pulley Ø	
				m	ft	mm	inch
FBSP65A10X35	10 x 35	1,6	19,8	30,0	100,0	+60	+2,4



PU75A Belt edge 17 x 33 mm, emerald green



approx. 80° Shore A

Order No.	Profile dimension mm	Cross section cm ²	approx. Weight kg/100 m	Standard Roll		Recommended Min.-pulley Ø	
				m	ft	mm	inch
FBSP17X33GG	17 x 33	2,54	30,4	30,0	100,0	+120	+4,75



PU65A Belt edge 10,5 x 22 mm, translucent green

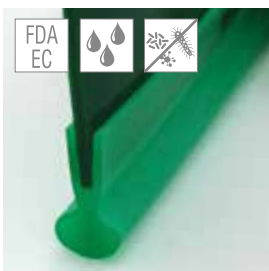

approx. 72° Shore A

Order No.	Profile dimension mm	Cross section cm ²	approx. Weight kg/100 m	Standard Roll		Recommended Min.-pulley Ø	
				m	ft	mm	inch
FBSP10,5X22TG	10,5 x 22	1,12	13,4	30,0	100,0	+70	+2,8



Type: flat foot very good weldability on PU belts



PU80A white



Order No.	Height (mm) H	Height (inch) H	Foot width (mm) B	Foot width (inch) B	Weight (g/m)	Min. pulley Ø		Standard Roll	
						mm	inch	m	ft
FBCJ025WUSX	25,00	1,00	12,50	0,50	154,00	60	2,4	20	65
FBCJ038WUSX	38,00	1,50	12,50	0,50	228,00	60	2,4	20	65
FBCJ050WUSX	50,00	2,00	12,50	0,50	302,00	60	2,4	20	65
FBCJ070WUSX	70,00	2,75	12,50	0,50	455,00	60	2,4	20	65

approx. 84° Shore A

PU80A green



Order No.	Height (mm) H	Height (inch) H	Foot width (mm) B	Foot width (inch) B	Weight (g/m)	Min. pulley Ø		Standard Roll	
						mm	inch	m	ft
FBCJ025GUSX	25,00	1,00	12,50	0,50	154,00	60	2,4	20	65
FBCJ038GUSX	38,00	1,50	12,50	0,50	228,00	60	2,4	20	65
FBCJ050GUSX	50,00	2,00	12,50	0,50	302,00	60	2,4	20	65
FBCJ070GUSX	70,00	2,75	12,50	0,50	455,00	60	2,4	20	65

approx. 84° Shore A

PU80A ultramarine blue



Order No.	Height (mm) H	Height (inch) H	Foot width (mm) B	Foot width (inch) B	Weight (g/m)	Min. pulley Ø		Standard Roll	
						mm	inch	m	ft
FBCJ025LUSAX	25,00	1,00	12,50	0,50	154,00	60	2,4	20	65
FBCJ038LUSAX	38,00	1,50	12,50	0,50	228,00	60	2,4	20	65
FBCJ050LUSAX	50,00	2,00	12,50	0,50	302,00	60	2,4	20	65
FBCJ070LUSAX	70,00	2,75	12,50	0,50	455,00	60	2,4	20	65

approx. 84° Shore A

PU80A sky blue



Order No.	Height (mm) H	Height (inch) H	Foot width (mm) B	Foot width (inch) B	Weight (g/m)	Min. pulley Ø		Standard Roll	
						mm	inch	m	ft
FBCJ025LUSX	25,00	1,00	12,50	0,50	154,00	60	2,4	20	65
FBCJ038LUSX	38,00	1,50	12,50	0,50	228,00	60	2,4	20	65
FBCJ050LUSX	50,00	2,00	12,50	0,50	302,00	60	2,4	20	65
FBCJ070LUSX	70,00	2,75	12,50	0,50	455,00	60	2,4	20	65

approx. 84° Shore A

PU80A safe capri blue



Order No.	Height (mm) H	Height (inch) H	Foot width (mm) B	Foot width (inch) B	Weight (g/m)	Min. pulley Ø		Standard Roll	
						mm	inch	m	ft
FBCJ025LCUSX	25,00	1,00	12,50	0,50	154,00	60	2,4	20	65
FBCJ038LCUSX	38,00	1,50	12,50	0,50	228,00	60	2,4	20	65
FBCJ050LCUSX	50,00	2,00	12,50	0,50	302,00	60	2,4	20	65
FBCJ070LCUSX	70,00	2,75	12,50	0,50	455,00	60	2,4	20	65

approx. 84° Shore A

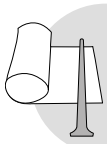

Type: feathered foot weldable on PU



PU90A white



Order No.	Height		Foot width (mm) B	Weight (g/m)	Min. pulley \varnothing		Standard Roll	
	(mm) H	(inch) H			mm	inch	m	ft
FBCJ020WX	20,00	0,79	10,0	75,00	60	2,4	20	65
FBCJ030WX	30,00	1,18	10,0	109,00	60	2,4	20	65
FBCJ040WX	40,00	1,57	10,0	129,00	60	2,4	20	65
FBCJ050WX	50,00	2,00	10,0	235,00	60	2,4	20	65
FBCJ060WX	60,00	2,40	10,0	280,00	60	2,4	20	65

approx. 92° Shore A

PU90A green



Order No.	Height		Foot width (mm) B	Weight (g/m)	Min. pulley \varnothing		Standard Roll	
	(mm) H	(inch) H			mm	inch	m	ft
FBCJ020GX	20,00	0,79	10,0	75,00	60	2,4	20	65
FBCJ030GX	30,00	1,18	10,0	109,00	60	2,4	20	65
FBCJ040GX	40,00	1,57	10,0	129,00	60	2,4	20	65
FBCJ050GX	50,00	2,00	10,0	235,00	60	2,4	20	65
FBCJ060GX	60,00	2,40	10,0	280,00	60	2,4	20	65

approx. 92° Shore A

PU90A ultramarine blue



Order No.	Height		Foot width (mm) B	Weight (g/m)	Min. pulley \varnothing		Standard Roll	
	(mm) H	(inch) H			mm	inch	m	ft
FBCJ020LAX	20,00	0,79	10,0	75,00	60	2,4	20	65
FBCJ030LAX	30,00	1,18	10,0	109,00	60	2,4	20	65
FBCJ040LAX	40,00	1,57	10,0	129,00	60	2,4	20	65
FBCJ050LAX	50,00	2,00	10,0	235,00	60	2,4	20	65
FBCJ060LAX	60,00	2,40	10,0	280,00	60	2,4	20	65

approx. 92° Shore A

PU90A sky blue



Order No.	Height		Foot width (mm) B	Weight (g/m)	Min. pulley \varnothing		Standard Roll	
	(mm) H	(inch) H			mm	inch	m	ft
FBCJ020LX	20,00	0,79	10,0	75,00	60	2,4	20	65
FBCJ030LX	30,00	1,18	10,0	109,00	60	2,4	20	65
FBCJ040LX	40,00	1,57	10,0	129,00	60	2,4	20	65
FBCJ050LX	50,00	2,00	10,0	235,00	60	2,4	20	65
FBCJ060LX	60,00	2,40	10,0	280,00	60	2,4	20	65

approx. 92° Shore A

PU90A safe capri blue



Order No.	Height		Foot width (mm) B	Weight (g/m)	Min. pulley \varnothing		Standard Roll	
	(mm) H	(inch) H			mm	inch	m	ft
FBCJ020LCX	20,00	0,79	10,0	75,00	60	2,4	20	65
FBCJ030LCX	30,00	1,18	10,0	109,00	60	2,4	20	65
FBCJ040LCX	40,00	1,57	10,0	129,00	60	2,4	20	65
FBCJ050LCX	50,00	2,00	10,0	235,00	60	2,4	20	65
FBCJ060LCX	60,00	2,40	10,0	280,00	60	2,4	20	65

approx. 92° Shore A



PUflex flat belt material for sidewalls

Flat belt strips for direct welding onto the conveyor belt

- Material extremely flexible with good abrasion and cut resistance
- Very good and easy weldability
- Food approval FDA/EC compliant
- For the individual implementation of your corrugated edge refinement

PU80A Flat belt 140 mm for sidewalls



very good and easy weldability

approx. 84° Shore A

Order No.	Color*	Profile thickness*		Belt width		Standard Roll	
		mm	inch	mm	inch	m	ft
FBFJ140X2WG	white	2,0	5/64	140	5,5	125	410
FBFJ140X2LB	blue green	2,0	5/64	140	5,5	125	410
FBFJ140X2GG	green	2,0	5/64	140	5,5	125	410
FBFJ140X2LG	sky blue	2,0	5/64	140	5,5	125	410
FBFJ140X2LA	ultramarine blue	2,0	5/64	140	5,5	125	410
FBFJ140X25GG	green	2,5	3/32	140	5,5	101	331
FBFJ140X25LA	ultramarine blue	2,5	3/32	140	5,5	101	331

*Further colours and belt thicknesses on request

Coeff. of friction μ : Steel: approx. 0,60 | PE: approx. 0,30 | HDPE: approx. 0,25 | **FDA/EC/USDA compliant**



Marking strips PU75A, 5 x 0,3 mm



Order No.	Color	Width mm	Thickness mm	Weight kg/100m	Standard Roll
FBFI5X03W	white	5,0	0,3	0,18	100 m
FBFI5X03S	black	5,0	0,3	0,18	100 m
FBFI5X03LB	sky blue	5,0	0,3	0,18	100 m
FBFI5X03LA	ultramarine blue	5,0	0,3	0,18	100 m
FBFI5X03R	pink	5,0	0,3	0,18	100 m



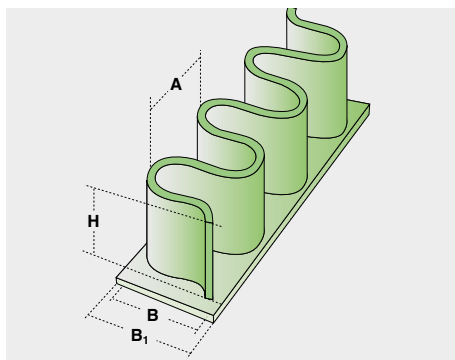

PUflex sidewalls with foot

Sidewalls with foot for welding onto the conveyor belt

- Extremely flexible material with good abrasion and cut resistance
- Very good and easy weldability
- Approved for use in food contact applications in compliance with FDA/EC
- The version with foot allows for particularly small pulley diameters on account of the high degree of undulation of the wave profile

PU80A white

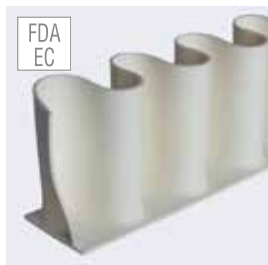

approx. 84° Shore A

FDA/EC/USDA compliant

Order No.	Height H		Wave width B	Base width B1	Pitch off waves A	Approx. weight	Standard Roll	Pulley diameter (∅)		
	mm	inch						Minimum	Recommended	Counterflex
FBV FH020W	20,00	0,79	23,00	32,00	25,40	174	100	35	70	70
FBV FH030W	30,00	1,18	23,00	32,00	25,40	220	100	55	80	110
FBV FH040W	40,00	1,57	23,00	32,00	25,40	265	100	75	90	150
FBV FH050W	50,00	1,97	23,00	32,00	25,40	310	100	80	100	160
FBV FH060W	60,00	2,36	45,00	55,00	50,80	445	100	90	110	180
FBV FH080W	80,00	3,15	45,00	55,00	50,80	544	50	125	130	250
FBV FH100W	100,00	3,94	45,00	55,00	50,80	642	50	155	160	310
FBV FH120W	120,00	4,72	45,00	55,00	50,80	741	50	170	185	340

PU80A green

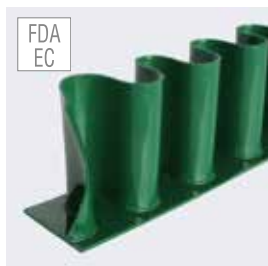

approx. 84° Shore A

FDA/EC/USDA compliant

Order No.	Height H		Wave width B	Base width B1	Pitch off waves A	Approx. weight	Standard Roll	Pulley diameter (∅)		
	mm	inch						Minimum	Recommended	Counterflex
FBV FH020G	20,00	0,79	23,00	32,00	25,40	174	100	35	70	70
FBV FH030G	30,00	1,18	23,00	32,00	25,40	220	100	55	80	110
FBV FH040G	40,00	1,57	23,00	32,00	25,40	265	100	75	90	150
FBV FH050G	50,00	1,97	23,00	32,00	25,40	310	100	80	100	160
FBV FH060G	60,00	2,36	45,00	55,00	50,80	445	100	90	110	180
FBV FH080G	80,00	3,15	45,00	55,00	50,80	544	50	125	130	250
FBV FH100G	100,00	3,94	45,00	55,00	50,80	642	50	155	160	310
FBV FH120G	120,00	4,72	45,00	55,00	50,80	741	50	170	185	340

PU80A sky blue

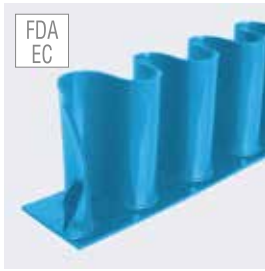

approx. 84° Shore A
FDA/EC/USDA compliant

Order No.	Height H	Height H	Wave width B	Base width B1	Pitch off waves A	Approx. weight	Standard Roll	Pulley diameter (∅)		
	mm	inch						Minimum	Recommended	Counterflex
FBVFH020L	20,00	0,79	23,00	32,00	25,40	174	100	35	70	70
FBVFH030L	30,00	1,18	23,00	32,00	25,40	220	100	55	80	110
FBVFH040L	40,00	1,57	23,00	32,00	25,40	265	100	75	90	150
FBVFH050L	50,00	1,97	23,00	32,00	25,40	310	100	80	100	160
FBVFH060L	60,00	2,36	45,00	55,00	50,80	445	100	90	110	180
FBVFH080L	80,00	3,15	45,00	55,00	50,80	544	50	125	130	250
FBVFH100L	100,00	3,94	45,00	55,00	50,80	642	50	155	160	310
FBVFH120L	120,00	4,72	45,00	55,00	50,80	741	50	170	185	340

PU80A ultramarine blue

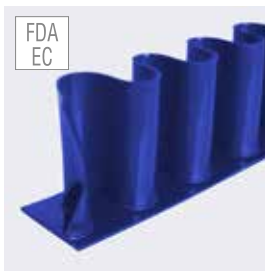

approx. 84° Shore A
FDA/EC/USDA compliant

Order No.	Height H	Height H	Wave width B	Base width B1	Pitch off waves A	Approx. weight	Standard Roll	Pulley diameter (∅)		
	mm	inch						Minimum	Recommended	Counterflex
FBVFH020LB	20,00	0,79	23,00	32,00	25,40	174	100	35	70	70
FBVFH030LB	30,00	1,18	23,00	32,00	25,40	220	100	55	80	110
FBVFH040LB	40,00	1,57	23,00	32,00	25,40	265	100	75	90	150
FBVFH050LB	50,00	1,97	23,00	32,00	25,40	310	100	80	100	160
FBVFH060LB	60,00	2,36	45,00	55,00	50,80	445	100	90	110	180
FBVFH080LB	80,00	3,15	45,00	55,00	50,80	544	50	125	130	250
FBVFH100LB	100,00	3,94	45,00	55,00	50,80	642	50	155	160	310
FBVFH120LB	120,00	4,72	45,00	55,00	50,80	741	50	170	185	340

PU80A safe capri blue

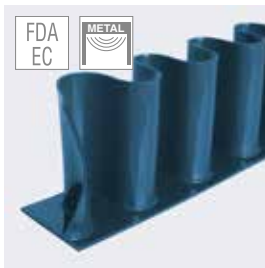

approx. 84° Shore A
FDA/EC/USDA compliant

Order No.	Height H	Height H	Wave width B	Base width B1	Pitch off waves A	Approx. weight	Standard Roll	Pulley diameter (∅)		
	mm	inch						Minimum	Recommended	Counterflex
FBVFH020LA	20,00	0,79	23,00	32,00	25,40	174	100	35	70	70
FBVFH030LA	30,00	1,18	23,00	32,00	25,40	220	100	55	80	110
FBVFH040LA	40,00	1,57	23,00	32,00	25,40	265	100	75	90	150
FBVFH050LA	50,00	1,97	23,00	32,00	25,40	310	100	80	100	160
FBVFH060LA	60,00	2,36	45,00	55,00	50,80	445	100	90	110	180
FBVFH080LA	80,00	3,15	45,00	55,00	50,80	544	50	125	130	250
FBVFH100LA	100,00	3,94	45,00	55,00	50,80	642	50	155	160	310
FBVFH120LA	120,00	4,72	45,00	55,00	50,80	741	50	170	185	340

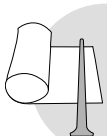

PU sheet material up to 8 mm thickness

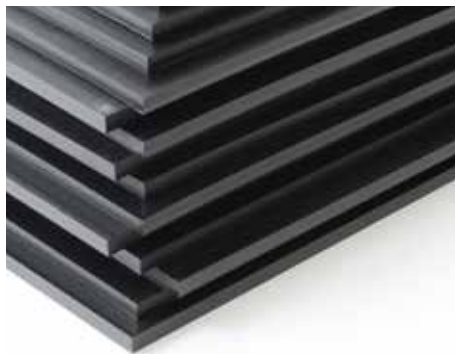

PU sheet material

BEHAbelt offers PU panels from 4-8 mm in 2 categories:

- Blue FDA-compliant versions with smooth surfaces in Shore 84A and 95A
- Industrial quality with smooth/fine structured surface in Shore 84A

Typical areas of application are: Welded-on profile (cleats), scraper, skirts, impact (damping) protection or seals.

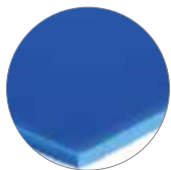



TOP SIDE: SMOOTH MATT (SM), WIDTH 750 mm



Bottom side	Color	Features	Quality	Hardness Shore	Profile thickness		Weight* per pc. approx. kg	Sheet length		Min. pulley ∅		Order No.
					mm	inch		m	ft	horizontal	vertical	
 smooth matt (SM)	UB	FDA EC	PU80A	84 A	4,0	0,16	4,3	1,2	4,0	40	55	FBPJ12754L
					5,0	0,20	5,4	1,2	4,0	50	70	FBPJ12755L
					6,0	0,24	6,5	1,2	4,0	60	80	FBPJ12756L
					8,0	0,31	8,6	1,2	4,0	80	100	FBPJ12758L
	UB	FDA EC, Water, Oil, Grease	PU95A	95 A	4,0	0,16	4,3	1,2	4,0	70	80	FBPM12754L
					5,0	0,20	5,4	1,2	4,0	90	105	FBPM12755L
					6,0	0,24	6,5	1,2	4,0	105	120	FBPM12756L
					8,0	0,31	8,6	1,2	4,0	140	150	FBPM12758L



TOP SIDE: SMOOTH MATT (SM), WIDTH 750 mm

Bottom side	Color	Features	Quality	Hardness Shore	Profile thickness		Weight* per pc. approx. kg	Sheet length		Min. pulley ∅		Order No.
					mm	inch		m	ft	horizontal	vertical	
 fabric impression (FI)	SW		PU80A	84 A	4,0	0,16	4,3	1,2	4,0	40	55	FBPJ12754S
					5,0	0,20	5,4	1,2	4,0	50	70	FBPJ12755S
					6,0	0,24	6,5	1,2	4,0	60	80	FBPJ12756S
					8,0	0,31	8,6	1,2	4,0	80	100	FBPJ12758S
 smooth matt (SM)	WE	FDA EC	PU80A	84 A	5,0	0,20	5,4	1,2	4,0	50	70	FBPJ12755W
					8,0	0,31	8,6	1,2	4,0	80	100	FBPJ12758W

Application examples



Buffer protection in the pellet depot



Cleats on conveyor belt



Work skirt e.g. in wood industry

* Sheet width 750 mm; Other panel lengths are also available on request

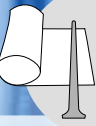

FABRICATION/ ENDLESS BELTS

Fabrication.....	92
Connection methods for profiles.....	93
Connection methods for monolithic flat belts.....	94
Fitting connectors for hollow round belts.....	95
Twisted round belts PU with hook connection.....	95

Fabrication

Our customers not only require belts by roll but also endless joined belts. This is why BEHAbelt offers “Express fabrication service”. Note: information on how to calculate a belt length for tailoring please refer to page 130.



Versatile

V- and Round and custom belt profiles in a variety of lengths and diameters and different shore hardnesses.

Welding of all belt geometries and coated belts!

Flexibel

When we designed the machines of our tailoring shop our goal was to being able to fabricate both, small and big quantities, at attractive cost and to ensure delivery of orders within a couple of days only - therefore we optimized machine set-up times and lead times.

Automated

An automated welding process ensures consistent quality.

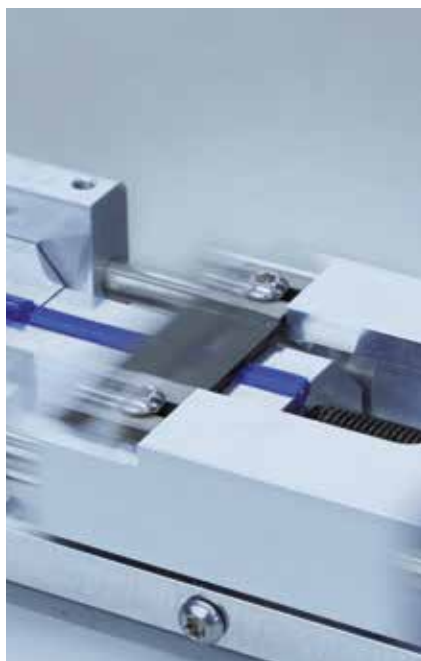

Services of Fabrication

We manufacture belt profiles and belts. The following list provides you with an overview of the currently available fabrications that BEHAbelt carries out itself. All other fabrications are covered by our partners.

Belt profiles

- Butt welding
- Butt welding with coating
- Butt welding with reinforcement
- Overlap welding with reinforcement
- Coating of belt profiles
- Twisted round belts
- Hollow round belts with quick connector
- Belt punching
- Belt notching
- Belt print and labeling

Flat belts

- Cut to width
- Butt welding (90° and 70°)
- Weld-on of belt profiles
- Machining of flat belts
- Belt print and labeling



Connection methods for profiles

Regardless of whether you are using unreinforced belts or reinforced belts, we distinguish the following connection methods: butt and overlap welding.

Two connection methods can be used on profiles with reinforcement. Butt welding to reduce elongation without changing the belt strength. Overlap welding to reduce elongation and increase the belt strength.

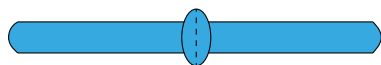

Butt welding without reinforcement

(Standard)

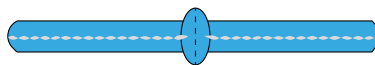

Butt welding with reinforcement

Butt welding to reduce elongation without changing the belt tensile force.

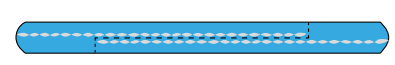

Overlap welding with reinforcement

Overlap welding to reduce elongation and increase the belt tensile force.







Joining methods: monolithic belts

Elastic monolithic PU conveyor belts from BEHAbelt offer new possibilities for endless joining due to the full PU belt construction. Due to the belt design without traction-layer, a connection by finger welding is no longer necessary, as the monolithic belt is a homogeneous belt design in itself - even in the joining area. A preferably homogeneous design of the joint is a quality criterion

both functionally and with regard to the elastic elongation behaviour of the monolithic strip. In principle, this potentially “inhomogeneous” area should be as narrow as possible, since the relatively large pretensioning force applied to monolithic tapes of 0.5...4% inhomogeneity in the tape is very quickly visible in the tensioned state.

Comparison of joining methods

					
		Butt welding	Overlap welding	Finger-joint	Electrode welding
PREPARATION	⊕	Single 90° cut or optional 70° for demanding pulley design.	Single 90° cut.		Single 90° cut.
	⊖		Preparation of the lap joint. To maintain the surface structure of the conveyor belt, it is necessary to insert embossing mats.	Preparation finger. To maintain the surface structure of the conveyor belt, it is necessary to insert embossing mats.	Belt edge should be chamfered slightly.
FINISHING	⊕		Rework normally not necessary.	Rework normally not necessary.	
	⊖	Welding seam must be removed with a knife.			Very time consuming to remove welding seam.
EQUIPMENT	⊕	Relatively easy and mobile welding by means of a heating paddle and joining table.			Very easy, only hot air gun and electrode.
	⊖		Can be performed with standard hot press. However, it is best to use a special tool with a narrow heating area.	Finger punching and heating press necessary.	

CHARACTERISTICS IN THE WELDING AREA

Homogeneity	⊕⊕	⊕⊕	⊕	⊖
Elasticity of belt	⊕⊕	⊕⊕	⊖	⊕
Maintain the belt structure	⊕⊕	⊕	⊕	⊕
CONCLUSION	recommended BEHAbelt standard	alternatively recommended belt welding	traditional belt welding	manual welding. Especially in container and funnel construction.



Butt welding with paddle welding tool



Overlap welding with hot press



Finger joint with a hot press



Welding with electrodes

Fitting connectors for hollow round belts

Fitting connectors for quick repairs

Hollow round belts should be welded just like solid belts.

In the case of a breakdown, fitting connectors can be used for a quick repair, until the belt can be welded once again. Another advantage is the flexibility of the belt for small pulley diameters. The hollow round belts can be connected via metal connectors, as shown in the picture.

For the insertion of the metal nipples it is recommended to use a pliers.

ATTENTION: Be sure to wear gloves to press fit the metal fitting connector. **Risk of injury!**

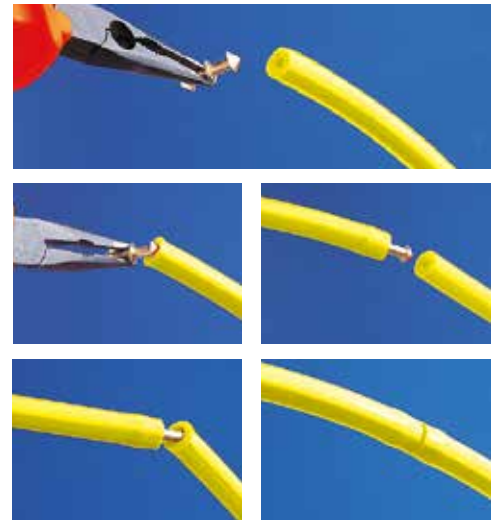

SZ01 pliers for pressing nipple connectors into hollow round belts.



Brass nipples

Description
Pliers SZ01

Order No.
FBWSZ01

Nipple for hollow round belts
(Outer diameter)
4,8 mm / 3/16"
6,3 mm / 3/16"
8,0 mm / 3/16"
9,5 mm / 3/16"
12,5 mm / 3/16"
15,0 mm / 3/16"

FBN048
FBN063
FBN080N
FBN095
FBN125
FBN150

Twisted round belts

Twisted PU round belts, also called "quick connect belts", are the perfect solution for roller conveyor systems where more than one belt is sitting on a shaft (called vertical drive).

Twisted belts are mounted with the hook open, which then is being closed with pliers once the belt is sitting in the right place.

Other material combinations on request.

Advantage

No costly and time consuming dismantling of shafts needed when installing or replacing a belt (short breakdown times).

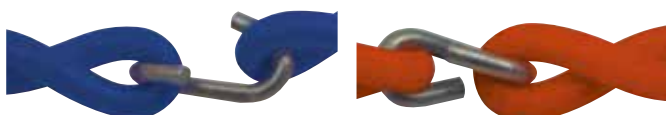

Construction: 2 x Ø 3 mm (Ø 5 mm)

You can find all product information on page 29



WELDING TOOLS

PROFILES

Friction welding machines.....	97
Paddle welding tools.....	100
Guiding clamps.....	104
Overlap welding with hot press.....	106
Overlap welding set with Z-paddle.....	111

FLAT BELTS

Heating paddle with joining table.....	113
--	-----

MISCELLANEOUS

Spare Parts & Accessories.....	115
Mandrel welding tools.....	119
LubeSite® Lubricators.....	120

RS02

The unique friction welding machine RS02 for polyurethane profiles eliminates downtime with a perfect weld on each application!

Features at a glance

- No long heating-up and set-up times, spliced within seconds.
- Precise pressure and automatical 0-positioning prevents uneven welds and premature failure.
- Automatic alignment ensures that the belt ends are aligned perfectly.
- Temperature variation is never a concern (no guess-work).
- Without the risk of injury or fire due to hot metal.
- Due to its small size the RS02 press can be used in confined spaces.
- Thanks to its exchangeable jaws the RS02 is suitable for splicing round belts from \varnothing 6 mm and V-belts from 6x4mm made of polyurethane.



original
DESIGN

Scope of delivery:

- 1 pc. Friction welding machine RS02
- 1 set standard profile jaws at your choice
- 1 pc. Torque wrench
- 1 pc. Scissors AS02
- 1 pc. Edge cutter SE02
- 1 pc. Carrying case with durable and predective foam inlay

Dimension (HxWxD): 390 x 105 x 123 mm
Weight: approx. 2450 g, Power: 500 W

Description
RS02, 230V

Order No.
FBWRS02230V



Tutorialvideo:
<https://youtu.be/7GhtkzLiyl>

RS02 AKKU

Battery-operated friction welding machine for polyurethane profiles for improved high-mobility maintenance.

Features at a glance

- Same characteristics as RS02,
but with the following distinguishing features:
- Cordless; battery-operated
 - Larger scope of delivery



original
DESIGN

Scope of delivery:

- 1 pc. Friction welding machine RS02 AKKU
- 1 set standard profile jaws at your choice
- 1 pc. Torque wrench
- 1 pc. Scissors AS04
- 1 pc. Edge cutter SE02
- 2 pcs. Battery pack
- 1 pc. Charger
- 1 pc. Assortment box
- 1 pc. Carrying case with durable and predective foam inlay

Dimension (HxWxD): 390 x 105 x 123 mm
Weight: approx. 2780 g, Power: 18 V 4Ah (72Wh)

Description
RS02 AKKU, 230V

Order No.
FBWRS02A230

Charger



Battery pack



Friction welding machines

Our Alu clamping jaw range

1 set of jaws consists of 4 parts

Features at a glance

- Please note each belt profile requires a matching set of jaws.
- Therefore, please select the appropriate clamping jaws for the required profile geometry.
- **On request, we also manufacture clamping jaws for PU special profiles.**

Round belts

RS Clamping jaws round belt Ø 6,0 mm	FBWSBR060
RS Clamping jaws round belt Ø 6,3 mm	FBWSBR063
RS Clamping jaws round belt Ø 7,0 mm	FBWSBR070
RS Clamping jaws round belt Ø 7,9 mm	FBWSBR079
RS Clamping jaws round belt Ø 8,0 mm	FBWSBR080
RS Clamping jaws round belt Ø 9,0 mm	FBWSBR090
RS Clamping jaws round belt Ø 9,5 mm	FBWSBR095
RS Clamping jaws round belt Ø 10,0 mm	FBWSBR100
RS Clamping jaws round belt Ø 12,0 mm	FBWSBR120
RS Clamping jaws round belt Ø 12,5 mm	FBWSBR125
RS Clamping jaws round belt Ø 12,7 mm	FBWSBR127
RS Clamping jaws round belt Ø 13,0 mm	FBWSBR130
RS Clamping jaws round belt Ø 14,0 mm	FBWSBR140
RS Clamping jaws round belt Ø 14,3 mm	FBWSBR143
RS Clamping jaws round belt Ø 15,0 mm	FBWSBR150
RS Clamping jaws round belt Ø 15,9 mm	FBWSBR159
RS Clamping jaws round belt Ø 17,0 mm	FBWSBR170
RS Clamping jaws round belt Ø 18,0 mm	FBWSBR180
RS Clamping jaws round belt Ø 19,0 mm	FBWSBR190
RS Clamping jaws round belt Ø 20,0 mm	FBWSBR200



for round belts



for V-belts

V-belts

RS Clamping jaws V-belt (Y) 6 x 4 mm	FBWSBK06
RS Clamping jaws V-belt (M) 8 x 5 mm	FBWSBK08
RS Clamping jaws V-belt (Z) 10 x 6 mm	FBWSBK10
RS Clamping jaws V-belt (A) 13 x 8 mm	FBWSBK13
RS Clamping jaws V-belt (B) 17 x 11 mm	FBWSBK17
RS Clamping jaws V-belt (C) 22 x 14 mm	FBWSBK22

V-belts special versions

RS Clamping jaws V-belt 8 x 6,5 mm	FBWSBK8X65
RS Clamping jaws V-belt 10 x 8 mm	FBWSBK10X8
RS Clamping jaws SuperGrip (Z) 10 x 6 mm	FBWSBK10G
RS Clamping jaws SuperGrip (A) 13 x 8 mm	FBWSBK13G
RS Clamping jaws SuperGrip (B) 17 x 11 mm	FBWSBK17G
RS Clamping jaws SuperGrip (C) 22 x 14 mm	FBWSBK22G
RS Clamping jaws (B) 17 x 11 for brush 90°	FBWSBK17B
RS Clamping jaws (C) 22 x 14 for brush 90°	FBWSBK22B

Rigide top V-belts

RS Clamping jaws SK1 (B) 17 x 19 mm	FBWSBK17X19
RS Clamping jaws SK1 (C) 22 x 24 mm	FBWSBK22X24

Twin V-belts

RS Clamping jaws Twin V-belt 21 x 8 mm	FBWSBK21X8
RS Clamping jaws Twin V-belt (Z) 24 x 6,8 mm	FBWSBK24X68
RS Clamping jaws Twin V-belt 30 x 8 mm	FBWSBK30X8

T-Profiles

RS Clamping jaws T-Profile 15 x 5 mm	FBWSBST15X5
RS Clamping jaws T-Profile 5 x 5 x 25 mm	FBWSBST5525

Special profiles

RS Clamping jaws Square profile 11,8 x 11,8 mm	FBWSBSQ118
RS Clamping jaws U-Profile 18 x 11,8 mm	FBWSBSU180
RS Clamping jaws Prism V-belt 33 x 8 mm	FBWSBS33X8
RS Clamping jaws Peach profile 28 x 29 mm	FBWSBS28X29

FRICION WELDING TECHNOLOGY FOR PU

The unique friction welding machine RS02 is the professional tool for the maintenance operator and also the fastest and most reliable way of welding belt profiles. Constantly good quality connections are produced in a few seconds with repeatable accuracy due to fixed welding parameters.

Welding clamping jaws tuned to the respective profile ensure reliable clamping and perfect alignment of the profile.

Thanks to its handy type of construction, the friction welding machine can even be used in narrow space conditions for comfortable welding. The recently developed battery version is now available to ensure unlimited freedom of motion.

USE

Which profiles can be welded?

The RS02 friction welding machine can be used for butt welding of PU round belts with/without reinforcement from 6 to 20 mm and PU V-belts with/without reinforcement from 6 x 4 mm to 22 x 14 mm.

Still many other geometrical shapes and special profiles can be joined by means of special clamping jaws using this welding technology

How does friction welding work?

Basically this welding technology uses the reciprocal coefficients of friction of the profile materials and thus effect fusion of the material in the joint under pressure and in executing a rotational movement. It is up to the user to decide when the process can be terminated when a welding bead has been produced all over the joint.

What has to be observed to produce a proper weld?

Clamping jaws tuned to the respective geometry are required for reliable clamping of the profiles during this procedure.

Flat and angularly cut belt ends are an important prerequisite for this welding procedure to create optimum welding conditions and produce friction over the entire joint surface. For belt profiles with reinforcement it is required before welding, as usual, to drill out the reinforcement at the joint surfaces by some millimetres to prevent the reinforcement from crossing in the joint and consequently deterioration of the welded connection.

An exception is the patented weldable glass fibre reinforcement of BEHAbelt where this working step is unnecessary.



Tutorialvideo on YouTube

HIGHLIGHTS

- **Mobile use** thanks to small design.
- Welding parameters defined by the speed and pressure.
- **TOP welding quality** thanks to welding results with repeatable accuracy.
- **Machine is immediately ready for use; no heating time required.**
- **High process mastery** with excellent repeat accuracy.
- **Reduction of the risk of accidents,** as no hot parts are involved.





Paddle lengths

EERGO 60

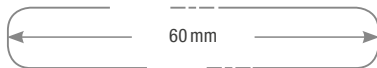

EERGO 90

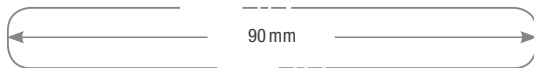

Scope of delivery:

- 1 pc. EERGO 60 oder 90
- 1 pc. Carrying bag

EERGO 60

Dimensions: 185 x 210 x 55 mm (HxWxD)
Weight: approx. 380 g, Power: 120 W

EERGO 90

Dimensions: 185 x 240 x 55 mm (HxWxD)
Weight: approx. 420 g, Power: 120 W

Description

EERGO 60, 230V/60 mm
EERGO 90, 230V/90 mm

Order No.

FBWEE001
FBWEE019

EERGO 60 & 90

The BEHAbelt EERGO paddle welding tools were specially developed for the connection of PU and TPE profiles or flat belt strips.

Features at a glance

- Strong, fiberglass-reinforced ergonomic housing.
- Unique control panel for one-handed operation.
- No adhesion of PU and TPE materials, thanks to Teflon-coated welding paddle.
- Easy cleaning with cloth.

Highlights



Heating-up time: approx. 5 minutes.



Innovative safety rest for safe placement on the work surface.



Ergonomic design for a natural working position.



Easy to use temperature selector regulates correct temperature to weld PU or TPE profiles.



Constant welding temperature at different ambient temperatures.



Spare parts

Spare paddle EERGO 60

Order No. **FBWEE002**
Dimensions (HxWxD): 43 x 65 x 6 mm



Spare paddle EERGO 90

Order No. **FBWEE025**
Dimensions (HxWxD): 43 x 95 x 6 mm



Tutorialvideo on YouTube

EERGO-Set „small“ 60

**Professional welding set for small profiles:
 Round belts up to 10mm and V-belts up to profile 10x6 (Z)**

- 1 pc. EErgo 60 paddle welding tool
- 2 pcs. Guide clamps FZ01
- 1 pc. Edge cutter SE02
- 1 pc. Scissors AS02 with stop
- 1 pc. Carrying bag small

EERGO-Set Vario „small“ 60

**Professional welding set for small profiles:
 Round belts up to 10mm and V-belts up to profile 10x6 (Z)**

- 1 pc. EErgo 60 paddle welding tool
- 1 pc. Guide clamp FZ01 Vario
- 1 pc. Edge cutter SE02
- 1 pc. Scissors AS02 with prism
- 1 pc. Carrying bag small



FZ01 Vario

EERGO-Set „universal“ 60

**Professional welding set for small and big profiles:
 round belts all sizes an V-belts up to profile 32 (D)**

- 1 pc. EErgo 60 paddle welding tool
- 2 pcs. Guide clamps FZ01
- 1 pc. Edge cutter SE02
- 1 pc. Scissors AS04 with stop
- 1 pc. Guide clamp FZ02/3
- 1 pc. Carrying bag big

EERGO-Set Vario „universal“ 60

**Professional welding set for small and big profiles:
 round belts all sizes an V-belts up to profile 32 (D)**

- 1 pc. EErgo 60 paddle welding tool
- 1 pc. Guide clamp FZ01 Vario
- 1 pc. Edge cutter SE02
- 1 pc. Guide clamp FZ02/3
- 1 pc. Scissors AS04 with stop
- 1 pc. Carrying bag big



FZ01 Vario



Description

EErgo-Set „small“ 230V / 60 mm
 EErgo-Set Vario „small“ 230V / 60 mm

Order No.

FBWEE003
 FBWEE011



Description

EErgo-Set „universal“ 230V / 60 mm
 EErgo-Set Vario „universal“ 230V / 60 mm

Order No.

FBWEE004
 FBWEE014



Polyurethane PU 290 °C
Polyester TPE 240 °C

**Continuously
temperature control**

Multi TC

BEHAbelt Multi TC is the proven continuously adjustable paddle welding tool for polyurethane and polyester.

Features at a glance

- Easy and safe handling.
- Very fast heating-up period.
- Variable temperature setting through adjusting wheel.
- Continuous welding temperature through temperature control even at long-term operation.
- LED display for signal of optimum welding temperature.
- Teflon coated welding paddle.
- Easy cleaning with cloth.

Scope of delivery:

1 pc. Multi TC welding tool
Temperature-controlled welding tool for two
temperature ranges: PU 290 °C / Polyester 240 °C

Dimensions: 295 x 35 x 25 mm (HxWxD)
Weight: approx. 250 g
Heating time: approx. 5 Min.
Temperature range: continuously 200...300 °C
Power: 75 W

Description
Multi TC 230 V

Order No.
FBWMTc230



Spare parts

Spare paddle Multi TC

Order No. **FBWMTc1**
Dimensions (HxWxD): 35 x 35 x 2 mm



Spare paddle Multi TC for flat belts

Order No. **FBWMTc2**
Dimensions (HxWxD): 25 x 70 x 2 mm



SG02 / SG03

The cost-effective welding technology.

SG02 for PU
SG03 for TPE

Features at a glance

- Easy and safe operation.
- Fixed, unregulated temperature setting.
- Reaches the welding temperature after approx. 10 min.
- Small, convenient and tough welding tool.
- No adhesion of PU and TPE materials, thanks to Teflon-coated welding paddle.
- Easy to clean with a cotton cloth.

Caution! Not suitable for continuous use.



Scope of delivery:

1 pc. SG02 welding tool
for Polyurethane (PU) 280 - 290 °C

or

1 pc. SG03 welding tool
for Polyester (TPE) 225 - 240 °C

Dimensions: 280 x 33 x 33 mm (HxWxD)

Weight: approx. 227 g

Heating time: approx. 10 Min.

Power: 80W (SG02); 40W (SG03)

Description

SG02 PU – 230 V

SG03 TPE – 230 V

Order No.

FBWSG02

FBWSG03

Spare parts

Spare paddle SG02 or SG03

Order No. **FBWTC72**

Dimensions (HxWxD): 35 x 35 x 2 mm



Spare paddle SG02 or SG03 for flat profiles

Order No. **FBWTC76**

Dimensions (HxWxD): 22,5 x 75 x 2 mm



Guiding clamps



For 90° welding

Dimensions (HxWxD):
205 x 90 x 100 mm
Weight: approx. 617 g



Example for special profile
adapter insert

Description

Guiding clamp FZ02/3
incl. Standard adapter insert
Adapter insert for special profiles

Order No.

FBWFZ02/3
FBWFZ020T00



Tutorialvideo on YouTube

FZ02/3

Guiding clamp FZ02/3 Standard

Robust and accurate for V-belts up to profile 32 (D)
and round belts from \varnothing 8 mm.

Adapter inserts for special profiles

Existing Geometries in mm: 12,5x5, 15x5, 16x8, 18x6,
24x6,8, 25x5, 30x8, 38x2, 6x4x9, 21x8, 28x10, flat profiles,
square profiles, U-profiles, T-Profiles 10x6, 28x10.
Other geometries on request.



Recommended for use with EErgo 60



For 90° welding

Dimensions: 205 x 90 x 100 mm (HxWxD)
Weight: approx. 617 g

Description

Guiding clamp FZ02/3F
Adapter insert for special profiles

Order No.

FBWFZ02/3F
FBWFZ020T00



Tutorialvideo on YouTube

FZ02/3F

Guiding clamp FZ02/3F for flat belts

Robust and accurate for flat profiles.
Width max. 80 mm and Height 1,6 - 5 mm.



Recommended for use with EErgo 90

FZ01 Vario

Guiding clamp FZ01 Vario metal can be assembled in two operating modes. With and without handle!

Convenient and tough for round belts up to \varnothing 10 mm and V-belts up to profile 10 (Z).
Exchangeable profile jaws allow custom profiles to be spliced easily.

Highlights

- Fast, reliable and exceptionally precise connecting of PU and TPE profiles.
- Special inserts for: PJ2, PJ3 and PJ4 ribbed V-belts.
- Your choice for standard and customized profiles!



Tutorialvideo on YouTube



Quick clamp device for inserting the profiles in exchangeable profile jaws.



Automatic unlocking starts off lateral pressure.



Precise welding thanks to constant pressure.

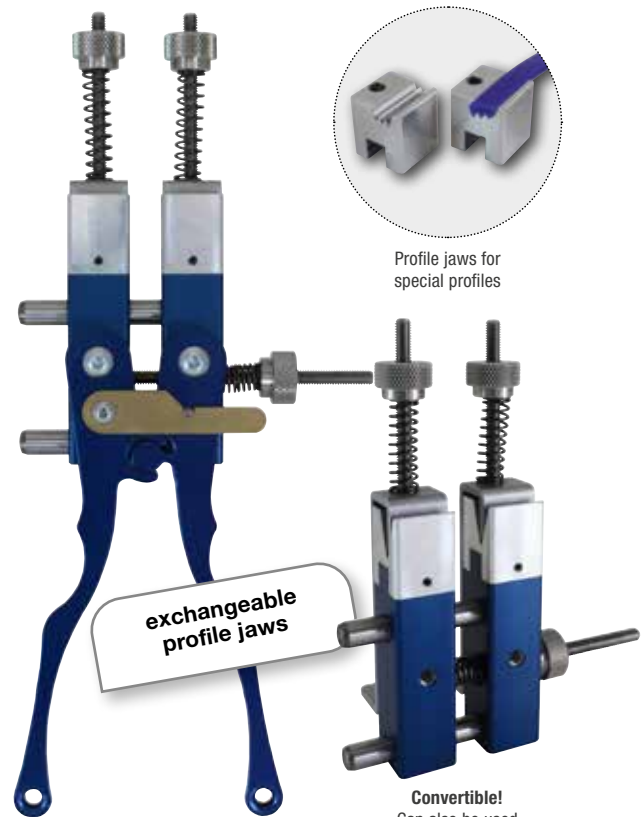

Profile jaws for special profiles

exchangeable profile jaws

Convertible!
Can also be used without handle.

Dimensions: 240 x 125 x 50 mm
140 x 195 x 50 mm without handle
Weight: approx. 365 g
approx. 320 g without handle

Description
FZ01 Vario
Profile jaws PJ2/PJ3/PJ4
Profile jaws T-Profile 10x4,5
Profile jaws T-Profile 9,5x3,5

Order No.
FBWFZ01V
FBWPBJ2-4
FBWPBT10x45
FBWPBT95x35

FZ01

Handy and lightweight guiding clamp for round belts up to \varnothing 10 mm and V-belts up to profile 10 (Z).

Highlights

- Fast, reliable and exceptionally precise connecting of PU and TPE profiles.
- Your choice for standard profiles!



Dimensions: 127 x 70 x 35 mm
Weight: approx. 140 g

Description
Guiding clamp FZ01

Order No.
FBWFZ01



Heating plate dimensions: 120 x 60 mm

Scope of delivery:

1 pc. Hot press HP01 AIR, 1 pc. PPuls Controller Element,
1 pc. Edge cutter SE02, 1 pc. Screw driver,
1 pc. Scissors AS04, 1 pc. Aluminium case

Dimensions (HxWxD): 240 x 167 x 200 mm

Weight: approx. 4800 g

Description

Standard Set HP01 /Air cooling, 230V

Order No.

FBWHP011L230

HP01 AIR

HP01 AIR is the air-cooled version of the hot press and offers mobility thanks to its compact design.

Features at a glance

- Very easy to use.
- Reduces operator errors through a fully automatic and controlled welding and vulcanization process.
- Thanks to its exchangeable moulds the HP01 is suitable for splicing many different profiles and flat belts made of PU and TPE as well as timing belts.
- User friendly operation through self-explanatory menu of controller (no expertise required).
- Perfect welding within minutes.
- Temperature variation is never a concern (no guesswork).
- Real time data logging & diagnostics function for quality assurance of the splice.
- Different types of welds possible (overlap welds, butt welds and angle welds).
- Due to its small size and the hook for hanging up the press during the welding process, the HP01 can be used in confined spaces "on-site".
- Best welding solution for reinforced profiles (aramid, polyester and steel) through overlap welding.



Tutorialvideo on YouTube

HP01 WATER

HP01 WATER is the water cooled version of the hot press and offers higher cooling capacity.

Features at a glance

Same characteristics as HP01 AIR, but with the following distinguishing features:

- Higher cooling capacity
- Cooling drum included in scope of supply
- Could also be cooled with compressed air



Description

Standard Set HP01/water cooling, 230 V

Order No.

FBWHP011W230

Scope of delivery:

1 pc. hot press HP01 WATER, 1 pc. Cooling unit 6,4 l with pump, 1 pc. PPuls Controller Element,
1 pc. Edge cutter SE02, 1 pc. Screw driver,
1 pc. Scissors AS04, 1 Set Connecting hoses,
1 pc. Aluminium case



Shaft for HP01 to use with torque wrench available as accessory

FBWHPSD12

Standard moulds for HP01 Hotpress

Moulds for PU and TPE round- and V-belts.
Other dimensions on request.



Mould for Twin V-belt

Round belts

Mould Ø 6,0 mm	FBWFS060
Mould Ø 6,3 mm	FBWFS063
Mould Ø 7,0 mm	FBWFS070
Mould Ø 8,0 mm	FBWFS080
Mould Ø 9,5 mm	FBWFS095
Mould Ø 10,0 mm	FBWFS100
Mould Ø 12,0 mm	FBWFS120
Mould Ø 12,5 mm	FBWFS125
Mould Ø 14,3 mm	FBWFS143
Mould Ø 15,0 mm	FBWFS150
Mould Ø 18,0 mm	FBWFS180
Mould Ø 20,0 mm	FBWFS200

V-belts

Mould (Z) 10x6 mm	FBWFS100X060
Mould (A) 13x8 mm	FBWFS130X080
Mould (B) 17x11 mm	FBWFS170X110
Mould (C) 22x14 mm	FBWFS220X140

V-belt special version

Mould 8x6,5 mm vaulted top	FBWFS080X065
Mould 10x8 mm	FBWFS100X080
Mould 16,35x11,3 mm (bluepower)	FBWFS163X113
Mould 17x11,3 mm (bluepower)	FBWFS170X113

Timing belts (width max. 50 mm)

Mould for timing belt HTD5	FBWFZHTD5MN
Mould for timing belt HTD8	FBWFZHTD8MN
Mould for timing belt T5	FBWFZT5N
Mould for timing belt T10	FBWFZT10N
Mould for timing belt AT5	FBWFZAT5N
Mould for timing belt AT10	FBWFZAT10N
Mould for timing belt AT20	FBWFZAT20N
Mould for timing belt H (B: 50,8 mm/2")	FBWFZH0
Mould for timing belt L (B: 50,8 mm/2")	FBWFZL0
Mould for timing belt RPP 8M	FBWFZRPP8MN



Mould for timing belt

Belt edge special version

Mould 14x28 mm	FBWFS14X28
----------------	------------

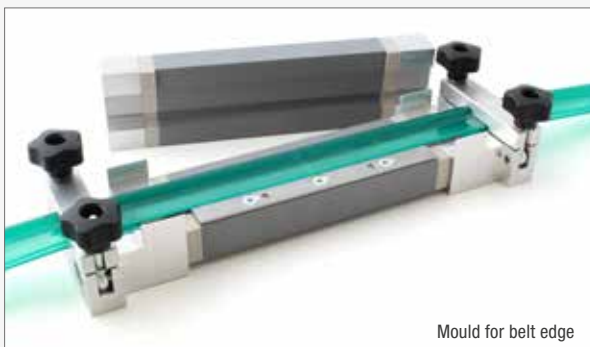

Mould for belt edge



We would be happy to check the realisation for your belt edge profile.

Belt edge profiles can be found on page 83.





SH01

Designed to accurately cut and prepare reinforced profiles for overlap welding with the BEHAbelt HP01 hot press.

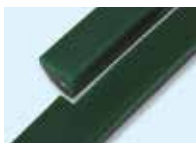

Before overlap welding

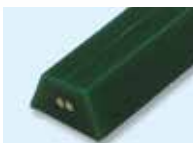

After overlap welding

Scope of delivery

- 1 pc. Belt cutter SH01
- 1 pc. Screwdriver
- 1 pc. Profile adapter at your choice
- 1 pc. End wrench
- 1 set Washers

Adapters available for the following profiles:

- Round belts \varnothing 6,0 - 20,0 mm
- V-belts 13 x 8 (A), 17 x 11 (B), 22 x 14 (C), bluepower

Dimensions (HxWxD): 200 x 80 x 45 mm

Weight: approx. 1,3 kg

Description

Belt cutter SH01
with 1 profile adapter at your choice

Order No.

FBWSH1

Profile adapters for round belts

Order No.	Description	Dimensions (mm)
FBWSH1R060	Profile adapter for round belts	\varnothing 6,0
FBWSH1R063	Profile adapter for round belts	\varnothing 6,3
FBWSH1R080	Profile adapter for round belts	\varnothing 8,0
FBWSH1R095	Profile adapter for round belts	\varnothing 9,5
FBWSH1R100	Profile adapter for round belts	\varnothing 10,0
FBWSH1R120	Profile adapter for round belts	\varnothing 12,0
FBWSH1R125	Profile adapter for round belts	\varnothing 12,5
FBWSH1R150	Profile adapter for round belts	\varnothing 15,0
FBWSH1R180	Profile adapter for round belts	\varnothing 18,0
FBWSH1R200	Profile adapter for round belts	\varnothing 20,0

Formnester für Keilriemen

Order No.	Description	Dimensions (mm)
FBWSH1K10	Profile adapter for V-belts	10 x 6 (Z)
FBWSH1K13	Profile adapter for V-belts	13 x 8 (A)
FBWSH1K17BP	Profile adapter for V-belts bluepower	17 x 11,3
FBWSH1K17	Profile adapter for V-belts	17 x 11 (B)
FBWSH1K22	Profile adapter for V-belts	22 x 14 (C)
	Profile adapters for special profiles on request	



Profile adapter for round belts



Profile adapter for V-belts

Joining Set CRIMP* - for steel reinforced profiles

The new and improved CRIMP connection supports you to achieve perfect results when connecting belts with steel reinforcement.



Canning industry: Crimp Connection

A special design is the connection of belts with steel reinforcement. Here, the exposed reinforcement is connected with press sleeves and the resulting gap in the connection point is then filled again with material inserts/welding sleeves. Using a profile mould and a hot press, the splice zone is then filled up and welded by pressure and temperature to the rest of the belt.

Our RH-2 joining set is available for this purpose and provides you with the complete equipment and material for creating such a splice.



Tutorialvideo on YouTube



1
Join exposed reinforcement
with press sleeves



2
Fill the gap with
material inserts



3
Positioning of the unwelded
splice into the mould

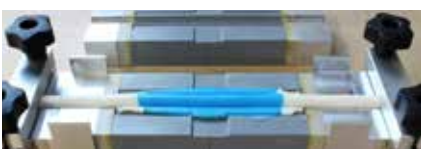

4
Profile joined by
hot press



Carrying bag



CU crimps



Inner outer welding sleeves

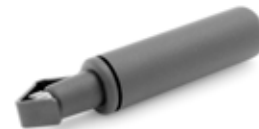

Cable stripper cutter
for can cable



Stripping hook for can cable



Crimping tool RH-2

Scope of delivery CRIMP-Set RH-2

- 1 pc. Carrying bag
- 1 pc. Crimping tool RH-2
- 1 pc. Cable stripper
- 1 pc. Stripping hook
- 3m respectively polyester sleeves (outside/inside)
- 100 pcs. CU crimps

Description

Crimp-Set RH-2 \varnothing 9,5 mm
Crimp-Set RH-2 \varnothing 10 mm
Crimp-Set RH-2 \varnothing 12 mm
Crimp-Set RH-2 \varnothing 12,5 mm

Order No.
FBWRH2SET095
FBWRH2SET100
FBWRH2SET120
FBWRH2SET125

* Ferrules

GENERAL

This welding technology provides perfect process control with the BEHbelt HP01 hot press especially developed for belt profiles and the associated PPuls Element temperature control for sophisticated industrial production of a welded connection.

Thanks to the small design and a number of smart design details this hot press is perfectly suitable for on-site use and in confined spaces. The unit can be made upon request of the customer as a water or air cooled version.

HP01 is the best choice for the best welding results in particular for the production of overlap welds of belt profiles.

USE

Overlap joints

HP01 is particularly well suited for the production of butt and overlap welds for round and V-belts with a diameter from 6 to 20 mm and for V-belts from 6x4 to 22x14 mm. A suitable mould is used to press the splice under temperature and pressure influence thus producing a firm connection.

For overlap welding, a preparatory work step is required to prepare the welding point by cutting the belt to size. For this purpose the special cutting aid SH01 has been developed which ensures precise preparation for welding in repeatable accuracy. The overlap weld thus achieves the strength of approx. 50% of the reinforcement used. Overlap welding always results in a stiff welding area and therefore it is required to consider this fact when selecting the minimum pulley diameter.

Timing belts and flat belts

Hot press HP01 also offers a further additional benefit with regard to the option of welding timing belts and flat belts up to the max. width of 50 mm in using appropriate moulds. The respective mould delivery program is available. Punching technology for preparation of the connection is not available.

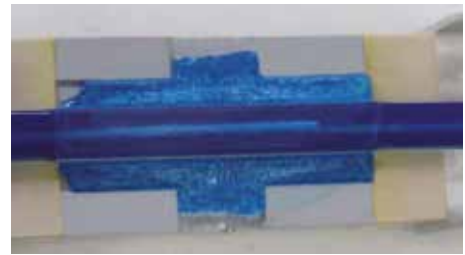
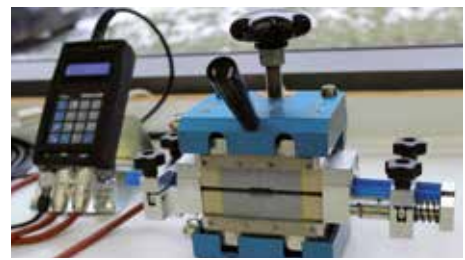

Tutorialvideo on YouTube



Moulds also available for flat belts and timing belts!

FZ03/1 & EErgo Z

Overlap welding set consisting of guide unit and EErgo Z

Product features FZ03/1

- Professional and easy to use guide clamps for overlap welding of reinforced profiles.
- Completely tool-free adjustment of the welding position for welding with Z-paddle.
- Uniform contact pressure over the entire welding surface of the profile for perfect welding quality
- Application range for round belts from 6-20mm and for V-belts from 8x5mm to 32x20mm.
- Safe handling with high repeat accuracy of the welding position thanks to toggle lever.
- Scope of delivery includes assembly option with table mounting and vice.
- Unique contact pressure in radial and axial alignment!

Product features EErgo-Z

- Robust, fibreglass-reinforced and ergonomic handle.
- Special Z-paddle for overlap welding with guide clamp FZ03/1.
- Correct temperature setting thanks to predefined buttons per welding material (PU 280 °C / Polyester 240 °C).
- Precise and stable temperature control for avoidance of temperature fluctuations under different welding conditions
- No adhesion of PU and TPE material thanks to Teflon-coated welding paddle
- Matching magnetic storage stand for safe storage of the welding paddle even when welding in the system

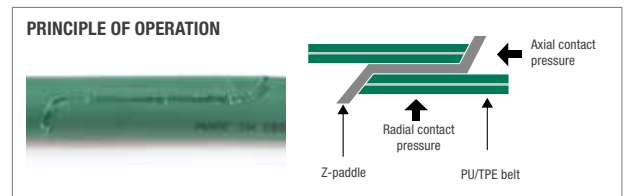

Compact guide unit for overlap welding by means of Z-paddle with vertical and horizontal contact pressure



Hot paddle welding tool EErgo with Z-paddle

Spare parts

Spare paddle EERGO-Z

Order No. **FBWEE024**

Dimensions (WxDxH):
approx. 100 x 65 x 6 mm



Scope of delivery:

1 pc. Set FZ03/1 (consisting of: FZ03/1, EErgo Z, Storage stand with magnetic base, AS04, SE02, 1 set of Clamping pieces of your choice, table mounting, Carrying case, Instruction manual)

Description

FZ03/1 Set
8,0 kg, approx. 550 x 210 x 350 mm (WxDxH)

Order No.

FBWFZ03/1A

EErgo-Z
450 g, approx. 210 x 210 x 55 mm (WxDxH)
Power: 240 W

FBWEE026

FZ03/1 Guide Unit
3,3 kg, approx. 210 x 250 x 70 mm (WxDxH)

MBWFZ03/1A

Overlap welding set with EErgo-Z

Clamping pieces for FZ03/1

1 set of clamping pieces consists of 2 parts

Features at a glance

- Please note each belt profile requires a matching set of clamping pieces.
- Therefore, please select the appropriate clamping pieces for the required profile geometry.
- **On request, we also manufacture clamping pieces for PU special profiles.**

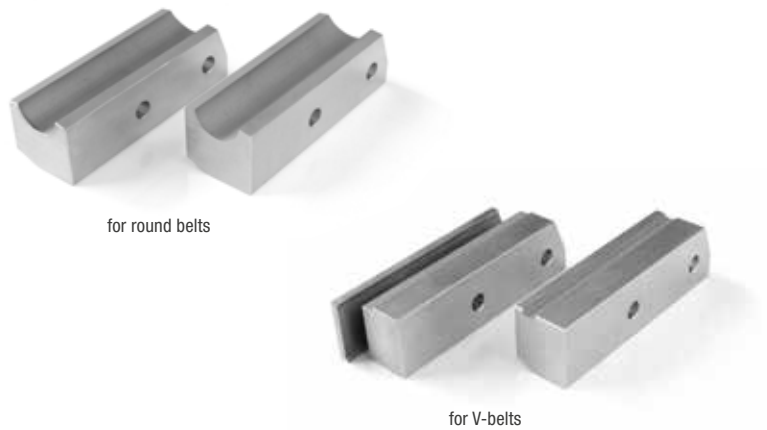

Round belts

Clamping piece for FZ03/1 Ø 6,0 mm	FBWKS1R060
Clamping piece for FZ03/1 Ø 6,3 mm	FBWKS1R063
Clamping piece for FZ03/1 Ø 7,0 mm	FBWKS1R070
Clamping piece for FZ03/1 Ø 7,9 mm	FBWKS1R079
Clamping piece for FZ03/1 Ø 8,0 mm	FBWKS1R080
Clamping piece for FZ03/1 Ø 9,5 mm	FBWKS1R095
Clamping piece for FZ03/1 Ø 10,0 mm	FBWKS1R100
Clamping piece for FZ03/1 Ø 12,0 mm	FBWKS1R120
Clamping piece for FZ03/1 Ø 12,5 mm	FBWKS1R125
Clamping piece for FZ03/1 Ø 12,7 mm	FBWKS1R127
Clamping piece for FZ03/1 Ø 13,0 mm	FBWKS1R130
Clamping piece for FZ03/1 Ø 14,0 mm	FBWKS1R140
Clamping piece for FZ03/1 Ø 14,3 mm	FBWKS1R143
Clamping piece for FZ03/1 Ø 15,0 mm	FBWKS1R150
Clamping piece for FZ03/1 Ø 15,9 mm	FBWKS1R159
Clamping piece for FZ03/1 Ø 17,0 mm	FBWKS1R170
Clamping piece for FZ03/1 Ø 18,0 mm	FBWKS1R180
Clamping piece for FZ03/1 Ø 19,0 mm	FBWKS1R190
Clamping piece for FZ03/1 Ø 20,0 mm	FBWKS1R200

V-belts

Clamping piece for FZ03/1 (M) 8x5 mm	FBWKS1K8
Clamping piece for FZ03/1 (Z) 10x6 mm	FBWKS1K10
Clamping piece for FZ03/1 (A) 13x8 mm	FBWKS1K13
Clamping piece for FZ03/1 (B) 17x11 mm	FBWKS1K17
Clamping piece for FZ03/1 (C) 22x14 mm	FBWKS1K22
Clamping piece for FZ03/1 (D) 32x20 mm	FBWKS1K32



In the upper part of the transport bag there is a generally usable space for the side cutter SE02 and free compartments for 9 optional clamping piece pairs.



Robust transport case for the overlap welding set FZ03/1.

HS400 & 800

Specially developed hot paddles for butt welding of conveyor belts. The design of the welding device allows easy and professional handling.

Product features

- HS400 for up to 400 mm belt width
- HS800 for up to 800 mm belt width
- Sophisticated design with positioning aids and stoppers ensures highly repeatable accuracy of weldings
- Clamping lever with locking device
- Robust and handy design of the individual components
- Exact temperature adjustment via control unit
- No adhesion of PU or TPE material due to Teflon-coated heating paddle
- Easy cleaning of the heating blade with a cotton cloth
- Reduced risk of injury during cutting due to practical cutting device
- Welding unit delivered in a mobile, stable transport box for easy use on site
- Smallest weldable belt length $L_f = 800$ mm



HS400S / HS800S

Special design for short belt lengths from $L_f = 500$ mm



Scope of delivery:

- 1 pc. HS 400-Set (consisting of HS-BOX, HS400, FT400, Bead remover, insert-bar and transport case 400)
- 1 pc. HS 800-Set (consisting of HS-BOX, HS800, FT800, Bead remover, insert-bar and transport case 800)

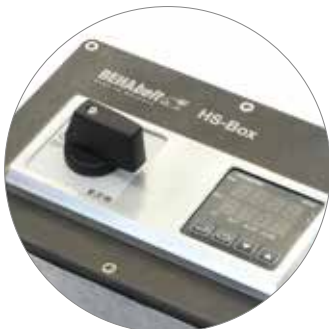

Robust and easy to use control unit for temperature control



Insert bar for repeatable welds

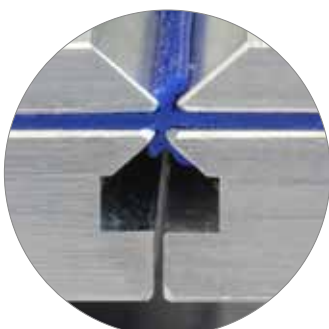

Clamping bars with chamfer for optimum shaping of the welding bead



Easy removal of the welding bead with the supplied tool

Description

HS400 Welding set in case
35,0 kg, approx. 50 x 95 x 30 cm (BxLxH)

HS800 Welding set in case
48,0 kg, approx. 50 x 135 x 30 cm (BxLxH)

Order No.
FBWHS400

FBWHS800

Individual components:

HS BOX (Control unit for HS400/800)
1,2 kg, approx. 18 x 20 x 15 cm (WxLxH)
Power: max. 3,2 kW / 230V AC

FBWHSB01

HS400 (Heating paddle 400mm)
1,2 kg, approx. 8 x 60 x 17 cm (WxLxH)
Power: 2,3 kW / 230 V AC

FBWHS400S01

HS800 (Heating paddle 800mm)
1,7kg, approx. 8 x 100 x 17 cm (WxLxH)
Power: 3,2 kW / 230 V AC

FBWHS800S01

HS400S (Heating paddle 400mm)
1,2 kg, approx. 8 x 60 x 17 cm (WxLxH)
Power: 2,3 kW / 230 V AC

FBWHS400S02

HS800S (Heating paddle 800mm)
1,7kg, approx. 8 x 100 x 17 cm (WxLxH)
Power: 3,2 kW / 230 V AC

FBWHS800S02

FT400 (Joining table for HS400)
12,5 kg, approx. 28 x 55 x 20 cm (WxLxH)

FBWHS400FT01

FT800 (Joining table for HS800)
20,0 kg, approx. 28 x 95 x 20 cm (WxLxH)

FBWHS800FT01



WELDING TECHNOLOGY FOR ELASTIC MONOLITHIC BELTS

Elastic monolithic PU conveyor belts from BEHAbelt offer new fabrication possibilities. Due to the lack of traction layers joining by finger welding is no longer necessary, as the monolithic belt has a homogeneous design – even in the weld seam.

The welding device HS from BEHAbelt is a simple, handy, reliable and cost-effective tool for butt joining of monolithic belts. Depending on customer requirements, two versions are available with the joining table and heating paddle for max. belt widths up to 400 and up to 800 mm.

The simple operation in combination with the intuitive production aids enables a repeatable and high-quality connection of the belts.

Optional adapter plates ensure precise positioning and clamping of the butt ends to be welded.



Compact and mobile: the practical HS welding tool for monolithic conveyor belts

Angle to straight (90°) and bias (70°) cutting of the belts directly in the welding unit (included in the scope of delivery).

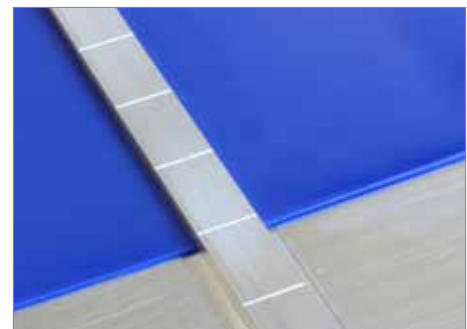

Precise and aligned insertion of the belt ends.



Tutorialvideo on YouTube



Robust aluminium bars support (70° and 90°) the precise insertion of the belt ends and ensures a high repeat accuracy (included in the standard scope of delivery).

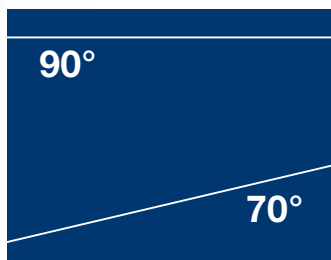

Straight weld with 90° and angled joint with 70° (e.g. for check weighers)



For optimum alignment and clamping of the belts to be welded in the joining table, optional adapter plates for more complex structures are available (not included in the standard product range).

Adapter plates for HS400 & 800

Adapter plates Spike (HS400)	FBWHS4APSP
Adapter plates Spike (HS800)	FBWHS8APSP
Adapter plates AT5 (HS400)	FBWHS4APT5
Adapter plates AT5 (HS800)	FBWHS8APT5



Locking pins ensure the correct positioning of the adapter plates on the joining table.



RS02 Adapter

Clamping jaw adapter aluminium for friction welding machines RS02 and RS02 CORDLESS

Description
RS02-Adapter Alu

Order No.
FBWAPRS02A



O-Rings for RS02-Adapter & clamping jaws

O-rings for fixing the clamping jaws and adapters in RS02 and RS02 CORDLESS

black, rubber, suitable for all RS clamping jaws and adapters

Description
O-Rings for clamping jaws (10 pcs.)

Order No.
MNORING01



Assortment box

Assortment box for clamping jaws for RS02 / RS02 CORDLESS

with 9 pockets, transparent Box

Description
Assortment box

Order No.
FBWSORT9



Hexagon wrench

for RSX01 Mandrel Welder

For loosening the clamping jaws on the RSX01 Mandrel Welder. Plug-in dimension 7 mm

Bezeichnung
Hexagon wrench

Best.-Nr.
FBWSW7X125



Hexagon torque wrench

RS Hexagon torque wrench 7 / 5 Nm

Description
Hexagon torque wrench

Order No.
FBWSW7/5NM



Protective cap for clamping lever RS02

For external thread of clamping lever on RS02 and RS02 CORDLESS

Description
Protective cap for clamping lever

Order No.
MFKKB01



Battery for RS02 CORDLESS

Spare battery for friction welding machine RS02 CORDLESS 18V / 4Ah (72Wh)

Description
RS02 Battery

Order No.
FBWRS02AK18V



Charging unit for RS02 CORDLESS

Charging unit 4A / 230V for RS02 CORDLESS

Description
LG4A Charging unit

Order No.
FBWRS02LG4A2



EM01 Deburring knife set and spare blades

Knife for removing the welding bead from conveyor belts incl. various replacement blades

Description	Order No.
Deburring knife Set	FBWEM001
Spare blades (10 pcs.)	FBWEM001B12
B 12 mm	



SH01 Spare blade

Spare blade for belt cutter SH01

Description	Order No.
SH01 spare blade	MBREKSH01



AS02

Scissors small with stop

90° cut for round belts up to Ø 12 mm.

Description	Order No.
AS02	FBWAS02



AS03

Scissors big with stop

For 90° cut and angle cut.

Description	Order No.
AS03	FBWAS03



AS04

Scissors big with angular stop (movable)

Scissors with movable angular stop
For 45°, 60°, 75°, 90°, 105°, 120° and 135° cuts.

Description	Order No.
AS04	FBWAS04



SE02

Edge cutter with special blade

to remove the welding bead accurately.

Description	Order No.
SE02	FBWSE02



SZ01

Pliers for fitting connectors

Description	Order No.
SZ01	FBWSZ01



Ratched cutter

For cutting very hard plastics e.g. PP, Nylon (PA), TPX, TPEE

Description	Order No.
Mandrel Scissors	FBWRM01



Paddle (MultiTC)

Spare paddle for welding tool „MultiTC“

Dimensions (HxWxD):
35 x 35 x 2 mm

Description **Order No.**
Spare paddle MultiTC **FBWMTC1**



Paddle (MultiTC)

Spare paddle for flat profiles for welding tool „MultiTC“

Dimensions (HxWxD):
25 x 70 x 2 mm

Description **Order No.**
Spare paddle MultiTC **FBWMTC2**



Paddle (SG02/03)

Spare paddle for welding tools „SG02/03“

Dimensions (HxWxD):
35 x 35 x 2 mm

Description **Order No.**
Spare paddle SG02/03 **FBWTC72**



Paddle (SG02/03)

Spare paddle for flat profiles for welding tools „SG02/03“

Dimensions (HxWxD):
22,5 x 75 x 2 mm

Description **Order No.**
Spare paddle SG02/03 **FBWTC76**



Paddle (EErgo 60)

Spare paddle for welding tool „EErgo 60“

Dimensions (HxWxD):
43 x 60 x 6 mm

Description **Order No.**
Spare paddle EErgo 60 **FBWEE02**



Paddle (EErgo 90)

Spare paddles for flat profiles for welding tool „EErgo 90“

Dimensions (HxWxD):
43 x 90 x 6 mm

Description **Order No.**
Spare paddle EErgo 90 **FBWEE025**



Paddle EErgo-Z

Spare paddle Z for paddle welding tool „EErgo“

Dimensions (WxDxH):
approx. 100 x 65 x 6 mm

Description **Order No.**
Spare paddle EErgo-Z **FBWEE024**



EErgo protection kit

Combustion protection for stationary operation

Consisting of holder and metal housing

Description **Order No.**
EErgo Metal housing **FBWEEZ001**
EErgo Holder **FBWEEZ002**



KS75

Bench vise with ball joint for paddle welding tools

Fix your welding tool to facilitate stationary joining of the belt profiles easier.

Description **Order No.**
KS75 **FBWKS75**



Storage Stand

Storage stand with magnetic base for placing of EErgo welding tool

Note: EErgo not included in scope of delivery

Description **Order No.**
Storage stand with magnetic base **FBWEEZ003**



Carrying bags

„M“: 28 x 29 x 5 mm
„XL“: 30 x 24 x 11 mm

Description	Order No.
Carrying bag „M“	FCT000000002
Carrying bag „XL“	FCT000000003



Stripping hook for can cable

For processing the CRIMP connection; for pulling off the profile around the steel tension member

Description	Order No.
Stripping hook	FBWAH01



Cable stripper cutter for can cable

90° cut for round belts with steel reinforcement up to Ø 12 mm.

Description	Order No.
Cable stripper	FBWAW01



Cutting adapter HS

For cutting the belts directly in the HS400/800 welding unit. For 70° and 90° butt welding.

Description	Order No.
Cutting adapter	FBWHSSA01



Special heating paddle HS400S/800S

Special design for welding belt lengths from Lf = 500mm

Description	Order No.
HS400S Heating paddle	FBWHS400S02
HS800S Heating paddle	FBWHS800S02



FZ01 knurled nut

Plastic or metal replacement nut (M5)

Description	Order No.
FZ01 nut plastic	MDFZ01001
FZ01 nut metal	MDFZ01002

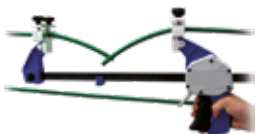

RSH01 & RSH02

Belt tensioner for tensioning of round and V-belts

RSH01 450 mm (18") tensioning distance, suitable to >1m belt length.

RSH02 900 mm (35") tensioning distance, suitable to >2m belt length.

Description	Order No.
RSH01 (450mm)	FBWRSH01
RSH02 (900mm)	FBWRSH02

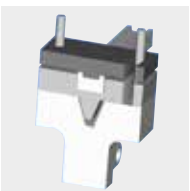

JOINING TOOLS FOR MANDRELS IN HOSE MANUFACTURING

BEHA Mandrel Welders are specially developed for welding mandrels made of PP, nylon (PA), TPEE and TPX. They are characterised by fast and error-free operation as well as simple and ergonomic handling.

More informationen: www.mandrel-welder.com



RSX01

With the RSX01 Mandrel welder, mandrels can be welded quickly and precisely. The welding parameters are optimally matched to the common materials, so that a high repetition accuracy is guaranteed with the simplest operation. As the splice is made by means of frictional heat, no long heating times are necessary.

Features

- Very quick connection of the hose mandrel ends by friction welding
- No danger of burns or fire
- Process reliability due to optimised welding parameters and exchangeable clamping jaws
- Can be used as manual or stationary solution
- Perfect weld joints



EErgo Mandrel

Practical and handy hot paddle welder with predefined temperatures for splicing mandrels made of PP, nylon, TPEE and TPX. The heating time is only 5 minutes and remains constant even with a wide range of ambient temperatures.

Features

- Fiberglass-reinforced ergonomic housing
- Easy operation: 1 Button for PP, 1 Button for Nylon, TPEE and TPX
- Alignment of mandrel ends with a guide clamp
- Ergonomic, user-friendly Design



LubeSite® automatic refill lubricators

Light construction



LubeSite® Series 200

LubeSite® 202, 205 and 260 within the clear-sight cages are the standard lubricators for most bearing applications.

They only supply lube oil, when the bearing is moving and therefore protect the bearing from over and under lubrication.

Units are assembled with medium sized springs. Three additional light and heavy springs are each included in a box of ten. Model 260 is delivered in a single package with additional springs (light, heavy).

Area of operation: -25...+120° C

Heavy construction



LubeSite® Series 300

LubeSite® 302, 305 und 360 are designed for bearing housings which operate under static conditions, vibration and centrifugal forces. The strong metal castings compensate for the heavy loads.

The main application areas are eccentric presses, compactors, stone mills, construction machines, pumps, etc.

Units are delivered with medium sized springs. Three additional light and heavy springs are each included in a box of ten. Model 360 is delivered in a single package with additional springs (light, heavy).

Area of operation: -25...+120° C

For chemically aggressive media



LubeSite® Series 500

LubeSite® 502, 505 and 560 is resistant to aggressive chemical agents. The light metal cases are made of special nickel-chrome double platen. The seals are plated with chemical resistant VITON.

The 500 series is a tried and tested product for many years in the chemical, food and nuclear industry.

Units are constructed with medium springs. Three additional light and heavy springs each are included in a box of ten.

Model 560 is delivered in a single package with additional springs (light, heavy)

Area of operation: -25...+120° C

For high temperatures



LubeSite® 704

LubeSite® 704 is the only automatic lubricator on the market, that can be used in ambient and high temperature applications. The case is made of light metal, the body is made of borosilicate glass, the pressure spring is made of high quality steel and the sealing is made of temperature consistent VITON.

LubeSite® 704 is used with best results within roller mills, plants, dehumidifiers, etc. Model 704 is delivered in a single package with one additional heavy spring.

Area of operation: -25...+230° C

Adapter



possible applications

- Automotive industry
- Transport and aviation
- Car wash plant
- Fertiliser production
- Food industry
- Dairy production
- Printing plants
- Ceramic industry
- Paper manufactures
- Textile industry
- Wood industry
- Tobacco production
- Beverage production
- Mining industry
- Oil production



Typ	low	medium	strong	extra strong
	Spring resilience N tensioned/unstressed			
202	26/13 N	40/20 N	54/27 N	98/49 N
205	30/15 N	44/22 N	72/36 N	90/45 N
260	84/42 N	130/65 N	140/70 N	156/78 N
302	26/13 N	40/20 N	54/27 N	98/49 N
305	30/15 N	44/22 N	72/36 N	90/45 N
360	84/42 N	130/65 N	140/70 N	156/78 N
302	26/13 N	40/20 N	54/27 N	98/49 N
305	30/15 N	44/22 N	72/36 N	90/45 N
360	84/42 N	130/65 N	140/70 N	156/78 N
704	–	80/40 N	158/79 N	–

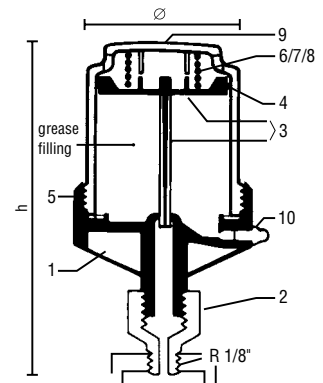

- 1 Body
- 2 screwed plug
- 3 Plunger and rod
- 4 O-Ring
- 5 Plunger and rod
- 6 Low spring
- 7 Medium spring
- 8 Strong spring
- 9 Clear case
- 10 Grease fitting



KNOW-HOW

PU and TPE material properties.....	122
Cleaning of profiles and belts.....	122
Chemical characteristics of PU and TPE	123
General directives for plastics with direct food contact.....	124
Pulley and drum design.....	125
Guiding concepts AT5.....	128
Pretension and tensioning devices	129
Calculations profiles and belts	130
Table with coefficient of friction.....	131
Quick guide for belt calculation.....	132
Table with manufacturing tolerances.....	133
Technical request	136



Polyurethane and polyester conveyor profiles and belts

- High tensile strength
- Excellent wear and abrasion resistance
- High resilience, low level of belt stretching
- Resistance to oil, grease, dirt and most chemicals
- Temperature resistance from -30°C to +60°C (dynamic)
- High coefficient of friction
- Silent running
- Excellent weldability
- Hydrolysis resistant
- Hygienic and easy to clean
- FDA/EC compliant



Cleaning of profiles and belts

Cleaning agents and interaction with PU belts

In the food industry, four main groups of cleaning agents are used: neutral, alkaline, acidic and chlorinated. The food manufacturer is responsible for selecting the optimum cleaning method and detergent. We will be pleased to advise you on all questions concerning the selection and suitability of conveyor belts for your production process.

Detergent group	Application	Compatibility with PU conveyor belts and profiles
Neutral	Suitable for many applications, good release properties against fats and proteins	durable
Alkaline	Suitable for the removal of carbohydrate, fat and protein deposits	durable
Acidic	Removal of inorganic components such as salts, calcium and lime deposits	durable
Chlorinated	Removal of stubborn organic residues such as proteins, carbohydrates and discolorations	not recommended

The test results have been determined under laboratory conditions and therefore only provide an indication of the chemical resistance.

Typical cleaning steps

A successful cleaning depends on 4 factors, whose mechanism of action is described in the professional world under the name 'Sinnischer Kreis':

- Mechanical energy (cleaning process or method)
- Chemical energy (detergents)
- Temperature (varies depending on contamination between cold and 60°, in exceptional cases food contact surfaces are rinsed with hotter water, but this is not the rule)
- Time (contact time of the detergents or disinfectants)

The cleaning of contact surfaces in contact with the product in the food industry comprises the following work steps:

1. pre-cleaning (removal of coarse impurities, often manually)
2. pre-rinse (to loosen stuck dirt if necessary)
3. cleaning (application and action of the cleaning agent)
4. rinse off
5. check cleaning result
6. disinfection
7. final rinsing



Chemical characteristics of PU and TPE



General

Thermoplastic material can be used in a variety of applications where there is interaction with various chemicals.

Chemical resistance depends on the period of exposure, the temperature, the quantity, the concentration and the type of the chemical substance. It is therefore difficult in any case to make a clear distinction between the effects described below. In the case of chemical degradation of polyurethane the chemical reaction results in cleavage of the molecular chains. In the course of degradation, polyurethane loses strength, and in extreme cases this can lead to disintegration of the part.

For critical applications, a detailed resistance test considering both swelling and the affect on mechanical properties is recommended.

Swelling

Swelling is the fundamental physical process of the absorption of liquid substances by a solid. In this process, the substance enters into the material without chemical interaction.

This results in an increase in volume and weight with a corresponding reduction in mechanical values. After evaporation a reduction in swelling occurs and the original properties of the product are almost completely restored.

Swelling is a reversible process. By using reinforcements in the polyurethane, for example polyester or aramid cords, you can almost avoid this mechanical impact on the material.



Hydrolysis resistance

If polyester-based polyurethanes are exposed for lengthy periods to hot water, moisture vapour or tropical climates, an irreversible break-down of the polyester chains occurs through hydrolysis. This results in a reduction in mechanical properties. This effect is more marked in flexible grades, where the polyester content is correspondingly higher than in the harder formulations.

Degradation of polyester-based polyurethanes is however rarely experienced at room temperature. Because of its chemical structure, polyester-based polyurethanes are much more resistant to hydrolytic degradation.

Microbiological resistance

When using polyester-based thermoplastic polyurethane under climatic conditions of high heat and humidity, parts can be damaged by microbiological attack. In particular, microorganisms producing enzymes are able to affect the molecule chains of polyester-based TPU.

The microbiological attack initially becomes visible as discoloration.

Subsequently, surface cracks occur which enable the microbes to penetrate deeper and to cause a complete destruction of the TPU.



General directives for plastics with direct food contact

There are several country-specific and global directives for the application of food contact materials. In general, all food contact materials have to be produced according to the principles of Good Manufacturing Practice (avoiding the occurrence of a health hazard or any other unacceptable change in the composition of the food during its intended use).



FDA Guideline “Title 21: Code of Federal Regulations”

The Food and Drug Administration of the Public Health Service of America is the world's best-known authority involved in consumer protection in respect of potential detrimental influences. The FDA has prepared a review “Title 21: Code of Federal Regulations” in respect of their approval of raw materials in a processed or finished state, and also specified the conditions under which the approval is valid.



EC Directive 1935/2004, EU Directive No. 10/2011

The framework Regulation EC 1935/2004 (EU Directive No. 10/2011) Food Contact and belonging specific Directive 2002/72/EC Monomers Additives of the European Parliament regulates plastics intended to come into contact with foodstuffs. The EU legislation for food contact materials is based on positive lists of the substances and maximum limits of migration into food. Only substance on these positive lists may be used for manufacturing plastics that are designated to

have food contact. Furthermore, you have to show the evidence of the global and specific migration. This can be requested and interpreted differently depending on the application.



Risiken erkennen – Gesundheit schützen

Federal Institute for Risk Assessment (BfR) recommendation „Plastics in the foodstuff chain“

The Federal Institute for Risk Assessment (previously the Federal Institute for Consumer Health Protection and Veterinary Medicine (BgVV)) was formed to increase the health protection of consumers and processes scientific recommendations and recognized orientation aids for possible health risks through materials that come into contact with foodstuff. These recommendations are listed in the „Recommendations within the framework of the German Food and Feed Code (LFGB)“.



USDA

The official United States Department of Agriculture is a part of the Federal Government of the United States of America. In addition to checking the use of raw materials in accordance with the FDA, the USDA also checks the suitability of the finished product (belt/conveyor) with regard to the cleanability of the product constitution (surfaces). Conformity in accordance with the USDA is primarily required for equipment in the processing of meat, poultry and milk in the United States of America.

HACCP concept

The Hazard Analysis and Critical Control Points concept (abbreviated: HACCP concept or HCCP concept) is a tool clearly aligned for structured and preventive measures. It is used to prevent risks in conjunction with foodstuff that can result in the consumer becoming ill.

This concept was developed around 1960. In German law, the HACCP concept was initially anchored into the Foodstuff Hygiene Ordinance from 1998. The EC Ordinance 852/2004 also provides for mandatory application of the HACCP concept in all companies engaged in the production, processing and sales of foodstuff.

The hygiene package accepted by the EU in 2004 came into force on the 1st January 2006. Herein, it is decreed that only foodstuff conforming to the directives of the HACCP must be handled and introduced into the Union.

Principles of the HACCP:

1. Carrying out a risk analysis
2. Identification of the critical checking points that the foodstuff is safe
3. Determining the intervention limits at the respective critical checking points
4. Establishing applicable monitoring procedures on the critical checking points
5. Establishing corrective measures in the event of deviations
6. Establishing assessment measures for checking the efficiency of the HACCP system determined
7. Establishing documentation of the measures

„What impact has the pulley diameter on the belt?“

The minimum pulley diameters are to be selected according to the values given in the tables. These have been chosen according to the material quality (Shore hardness) due to the relatively low transport speed - from experience less than 2 m per second. Since the goods are pulled, the drive pulley should be provided at the end of the transport path. The geared motors should always be equipped with a soft start or frequency converter.

The diameter of the pulley has a significant effect on the life (service life) of the belt. The specified minimum pulley diameters in mm should not be undercut, but rather chosen somewhat larger. Pulley diameters that are too small always have a detrimental effect on the service life, as extreme bending cycles lead to material fatigue. The specified minimum pulley diameters always refer to a wrap angle of 180°. The wrap angle indicates how many degrees the belt is guided around the pulley.

Recommended pulleys for round belts

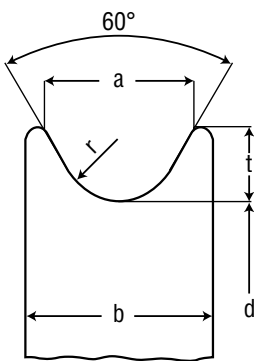

Belt Ø	2	3	4	4,8	5	6	6,3	7	8	9,5	10	12	12,5	15	18	20
a (mm)	4,5	5,5	7	8	8	10	10	11	12	14,5	15	18	18,5	23	28	30
b (mm)	6,5	8	10	12	12	14	14	15	16	19	19	22	23,0	27	32	36
t (mm)	2,5	3	3,5	4	4	5	5	5,5	6	7	7,5	9	9	12	14	15
r (mm)	1,4	1,9	2,5	3	3	3,5	3,5	4	4,5	5,5	5,5	6,5	7	8	9,5	11

Please select the appropriate minimum pulley diameter according to the different PU/Polyester qualities. The best qualified materials for pulleys are steel, high-alloyed steel, aluminium or Polyamid when it comes to plastic. Please keep in mind the low friction coefficient μ when using plastic material.

Pulleys for V-belts

Profile according to DIN 2215	6	8	10	13	17	22	32
Global standard acc. to ISO 4184	Y	M	Z	A	B	C	D
Upper width b (mm)	6	8	10	13	17	22	32
Height h (mm)	4	5	6	8	11	14	20
Lower width u (mm)	3,3	4,55	5,9	7,5	9,4	12,35	18,25
Pulley angle α	$\angle 34 - 38^\circ$						
Groove width b1	6	8	10	13	17	22	32
	→ depending on how much the profile should stick out above the upper pulley edge						
Groove depth t (mm)	h +2,0 mm						

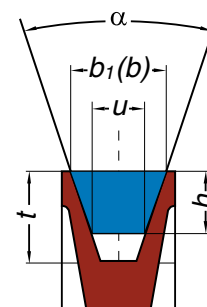

For BEHAbelt V-belts according to DIN 2215 / ISO 4184 pulleys for V-belts according to DIN 2217/ISO 4183 have to be used.





Design of pulleys for belt profiles

Considering the pairing of belts and pulleys it is generally recommended to work with materials and/or surface that create sufficient friction to PU/TPE e.g. Aluminium or Steel. This is important to ensure proper power transmission. Beware that Aluminium can lead to discoloration (blackening) of belts. All other pulleys, guiding elements or slider beds should be made of low-friction materials for example PE or HDPE.

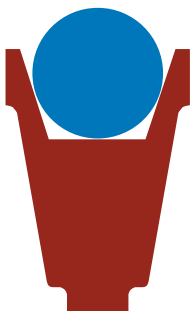

Grooved pulleys for round belts

In practice, V-belt pulleys are often used for round belt applications. You should know that this is not an optimal geometry pairing and should therefore be changed to a special round belt pulley if possible.

In addition to typical faster wear of the belt in the flank contact points, a V-belt pulley in this case can also cause the round belt to jam between the flanks of the pulley, which in turn can lead to additional stretching as well as „fluttering or jumping“ of the belt. Under these conditions, the service life of the belt is basically reduced. If V-belt pulleys are nevertheless used, the pulleys must be dimensioned so that the belt also makes contact with the base of the pulley.



Pulleys for T-Profiles

The power-transmission of such belts takes place on the flat area of the belt reverse side. This means the V-guide is not an element to transmit power but has guiding purpose only.

Hence, the guide should run free in the groove with little space and must never be clamped!



Pulleys for Twin V-belts

With twin V-belts, a distinction is made between the use as a drive conveyor belt or as spreader belt.

In the case of a drive, the pulley design must be in such a way that the power is transmitted by the flanks.

In spreading table applications, it has proved to be a good idea to guide the belt exclusively by the central groove and drive it by the underside of the profile.



Belt pulleys for V-guide for belts

The power transmission of belts takes place via the running side. This means that the centrally positioned V-guide only serves to guide the profile.

The V-guide must therefore be considered free-running in the belt pulley design. Clamping of the V-guide should be avoided.



Guide rails and supporting rollers

Grooved pulleys, supporting rolls and guide rails are recommended to keep the belting in position to carry the load. When guiding V-belts, the V belt groove should be designed so that the belt is being supported on the bottom of the groove and is only allowed to touch one side of the groove at a time to avoid jamming.

The diameter and number of the required supporting rolls depends on the length of the conveyor as well as on the weight and

dimensions of the goods to be conveyed. Supporting guide rails with a smooth surface can be grooved to support transport belts. The dimensions of the groove are to be designed in a width that prevents the belt from jamming. The guiding rails should be made of materials with good sliding qualities (PE – HDPE). If you are looking for a supplier please contact us, we can give you a recommendation.

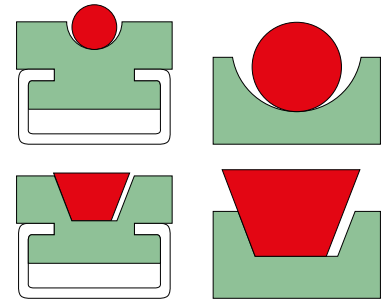

Drum design for conveyor belts

Crowned pulleys

To prevent the flat belts from slipping, at least one of the pulleys must be crowned, preferably the larger pulley or the one with the largest contact angle.

Commonly available pulleys are crowned in accordance with ISO 22. The larger the contact angle, the better the tracking effect for the belt.

In practice, the typical design of a crowned pulley is applied in three equal parts (conical/cylindrical/conical) based on the total drum length.

Pulley width

The width of the pulleys should be at least 1.05 to 1.1 times the belt width. In principle, we recommend that half of the belt width be cylindrical and conical towards the outside.

Drum surface

Clean and smooth running surfaces increase the efficiency and service life of conveyor belts.

The running surface of drive pulleys must not be too smooth or too rough (no knurled surfaces!) as this can lead to excessive belt wear, noise and premature belt failure.

We recommend to manufacture running surfaces with a roughness of $R_a = 1,6 \mu$ - $3,2 \mu$ - $6,3 \mu$.

Drive pulley design conveyor belt: Calculation

Length of cylindrical area b_c

$$b_c = b_0 / 2$$

Pulley width b

$$b = b_0 \times 1,1$$

Crown bow h

$$h = (d + 100) / 450 \text{ mm}$$

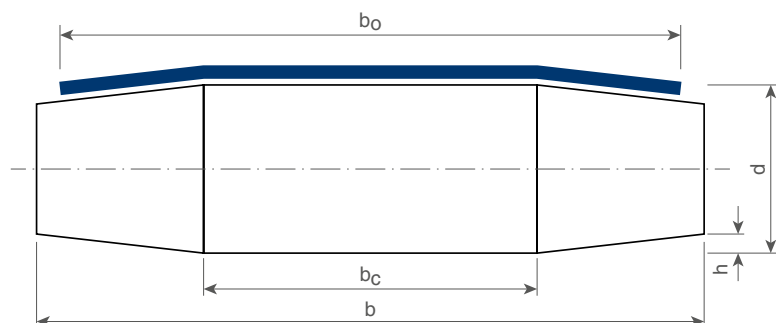

As a rule, machine designers traditionally use a drum design with the pitch 1/3 / 1/3 / 1/3. However, the 1/4 / 1/2 / 1/4 pitch has proven to be particularly suitable for soft belt types.



Introduction guiding concept for AT5

The interaction of AT5 drive with optimal belt guidance ensures track stability and slip-free drive. The preferred design for the belt guide takes into account a combination of guide groove in the belt and guide bar for the pulleys.

The position and number of guide grooves can be adapted to the requirements and conditions of the conveyor.

Several guide grooves basically increase the guide stability of the belt, whereby the arrangement of the guide grooves should preferably be centred in the middle of the belt and in the inner third of the belt width. Guide grooves near the outer edges of the belt are not recommended.

For cost reasons but also to simplify the implementation of the belt guiding concept, usually only the non-driven belt pulleys are designed as smooth rollers with guide bars, while the AT5 drive usually does without guide elements.

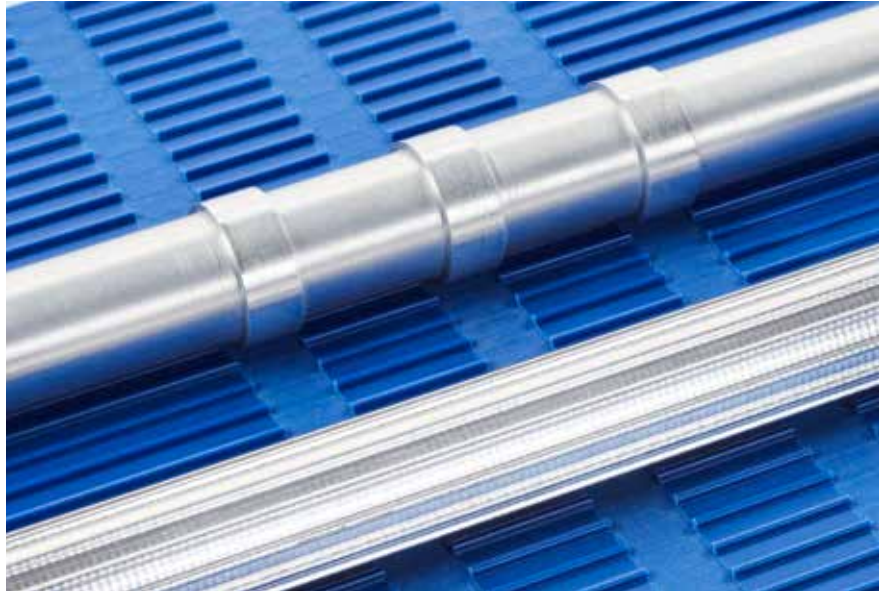

Typical design versions of the guide grooves in the belt are, for example, a groove width of 5 mm with a bar width of 15 mm between the grooves or a 10 mm groove with a bar width between the grooves of 20 mm. Depending on the belt width used, we recommend one to three

guide grooves up to a belt width of 300 mm and three to seven guide grooves from a belt width > 300 mm. In case of possible transverse loads on the belt, it is better to increase the number of guide grooves.

Design of the guide grooves in the conveyor belt

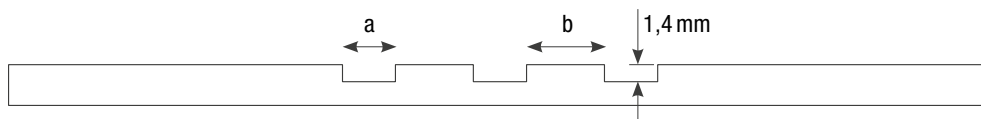

Design of the guide bars on the pulley

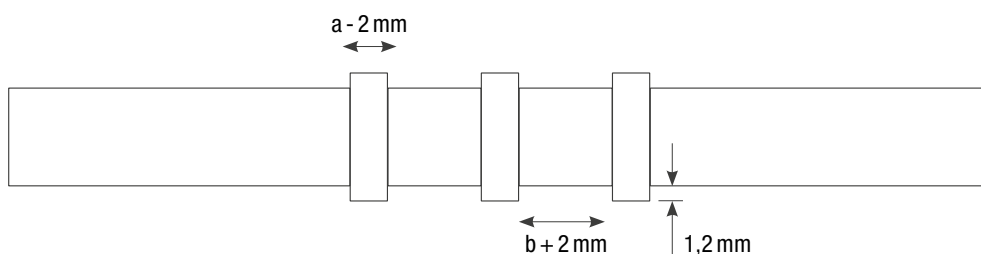

How does the pretension of a belt impact its lifetime?

The proper pre-tensioning of the belt is just as critical for belt performance as selecting the right belt and the right splicing system. For the recommended pretension please refer to the product tables of each belt in this delivery program.

Effects of wrong pretension:

Too low pretension results in slippage of the belt which generates excessive heat. This causes belt deformation, heavy abrasion, breaking and jumping out of the pulley.

Too high pretension may cause damage to pulleys, shafts and bearings. The belt permanently is over-tensioned and will prematurely fail due to material fatigue and formation of cracks. Furthermore the belt loses its material resilience.

Tensioning devices

A variety of tensioning devices can be used to accommodate the different amounts of stretch in belts or to make the installation process easier. In addition, for reinforced belts or belts with little pretension required, we recommend the use of tensioning devices permanently installed on the conveyor system. Please follow our recommended pretension for each belt to reduce premature wear and failure on your bearings. Common ways to properly tension a belt are as follows:

- cut the belt to a shorter length than the measured length of the conveyor system
- use a take up pulley or a deflection pulley with a counter weight or a mechanical screw movement
- the drive motor is moved in slotted mounting holes via an adjustment screw
- tensioning sled (the drive motor is mounted on rails and is moved by its own weight or by a screw mechanism)

- tensioning jack (the motor with the drive pulley is mounted on a turnable rocker. If the drive motor is running in the specified direction the backwards engine torque tension the belt automatically)

The right positioning of tensioning pulleys is essential for the lifetime and functionality of a belt. The tensioning pulleys always should be located in the return strand right after the drive pulley.

Working out the correct belt length

Use a string or steel tape to make measurements after reducing take-up (if installed) to the minimum. Distance between pulleys should remain fixed. To obtain good driving strength and good belt life, the belt pretension should be 0,5% to maximum 10%, based on hardness and length of the belt.

To verify pretension on an installed belt, apply two marks with a pen separated by 10 inches (or 100 mm) on the belt when it is free from tension. The increase of space between the marks after mounting the belt in tenths of an inch (or mm) provides a measure of the pretension in percent.

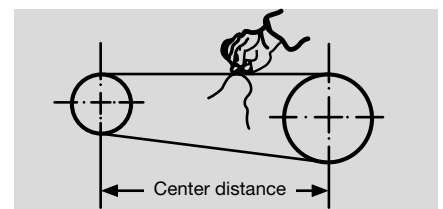

Calculation of belt length

Calculation of belt length

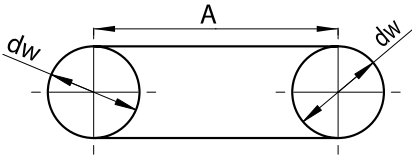

$L_{f1} = dw \times \pi + 2 \times A$

dw = effective diameter (position of the neutral fiber of belt)
 A = center distance
for round belts:
 $dw = d$ bottom of groove + diameter of belt

The recommended pretension has to be considered in addition!

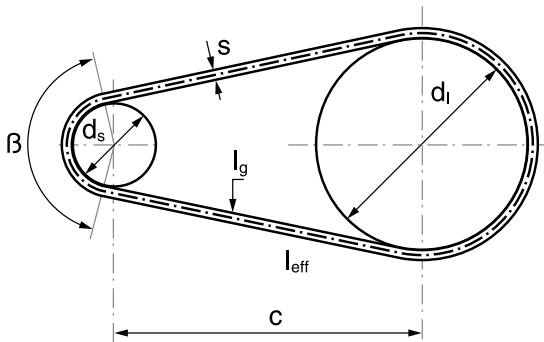

$$L_{eff} = 2c \cdot \sin\left(\frac{\beta}{2}\right) + \frac{\pi}{2} \left[d_s + d_l + 2s + \frac{(d_l - d_s)(180 - \beta)}{180} \right] \text{ [mm]}$$

$$\beta = 2 \arccos\left(\frac{d_l - d_s}{2c}\right) \text{ [}^\circ\text{]}$$

c = center distance [mm]
 d_s = Diameter of the small pulley [mm]
 d_l = Diameter of the big pulley [mm]
 β = Wrapping angle on small pulley

The recommended pretension has to be considered in addition!

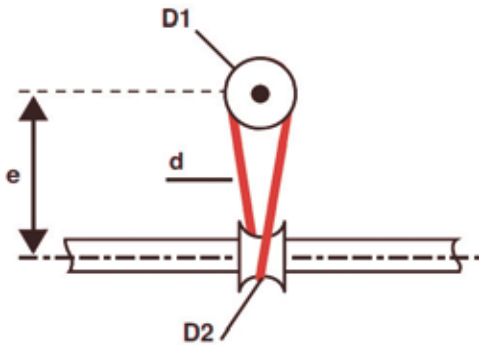

Lineshaft conveyor belts (semi-crossed)

$$L_{f3} = [(D1 + d) + (D2 + d)] \times \pi / 2 + 2 \times \sqrt{[(D1 + d)^2 / 4 + e^2]}$$

recomm. center to center distance: $4 \times D1$

$D1$: pulley diameter at bottom of groove
 $D2$: inner diameter of diabolo roller
 d : diameter of belt
 e : center distance

The recommended pretension has to be considered in addition

Auxiliary table / Quick reference for V-belts

Profile according to DIN 2215	6	8	10	13	17	22	32
Profile according to ISO 4184	Y	M	Z	A	B	C	D
Upper width b (mm)	6	8	10	13	17	22	32
Height h (mm)	4	5	6	8	11	14	20
Calculation of the belt length L_a and L_w , if L_i is determined or known	$L_a = L_i +$	25	31	38	50	69	126
	$L_a = L_w +$	10	12	16	20	29	51
L_a = outside length	$L_w = L_i +$	15	19	22	30	40	75
L_w = effective length / cut length	$L_w = L_a -$	10	12	16	20	29	51
L_i = inside length							

The recommended pretension has to be considered in addition

Coefficient of friction μ for smooth surfaces (G)

Quality	Alu	Steel	Glass	Wood (veneer)	PE	HDPE
PU40A	1,35	1,30	1,10	1,10	0,85	0,80
PU60A	0,95	0,90	0,75	0,80	0,55	0,50
PU65A	0,90	0,85	0,65	0,70	0,50	0,45
PU70A	0,85	0,75	0,60	0,70	0,40	0,35
PU75A	0,85	0,70	0,50	0,65	0,40	0,35
PU80A	0,80	0,65	0,45	0,60	0,35	0,30
PU85A	0,75	0,60	0,40	0,50	0,35	0,30
PU85A rough	0,55	0,45	0,45	0,45	0,30	0,25
PU90A	0,70	0,50	0,30	0,50	0,30	0,25
PU95A	0,65	0,45	0,25	0,45	0,25	0,20
TPE40D	0,70	0,50	0,30	0,45	0,25	0,20
TPE55D	0,45	0,35	0,30	0,35	0,20	0,15
TPE63D	0,45	0,35	0,30	0,35	0,20	0,15

Coefficient of friction μ for flat belt surfaces on steel (dry)

Quality	smooth gloss (SG)	smooth matt (SM)	fabric impression (FI)	rough impression (RI)	Diamond (ID)	Slightly rough (SR)
PU65A	0,85	0,80	0,70	0,75	0,65	0,70
PU75A	0,70	0,65	0,55	0,50	0,50	0,55
PU80A	0,65	0,60	0,50	0,40	0,45	0,50
PU95A	0,45	0,40	0,30	0,20	0,25	0,30
TPE55D	0,35	0,30	0,25	0,15	0,20	n/a

V-belt dimensions according to DIN 2215 and ISO 4184

All V-belts are produced with a small radius at the edges

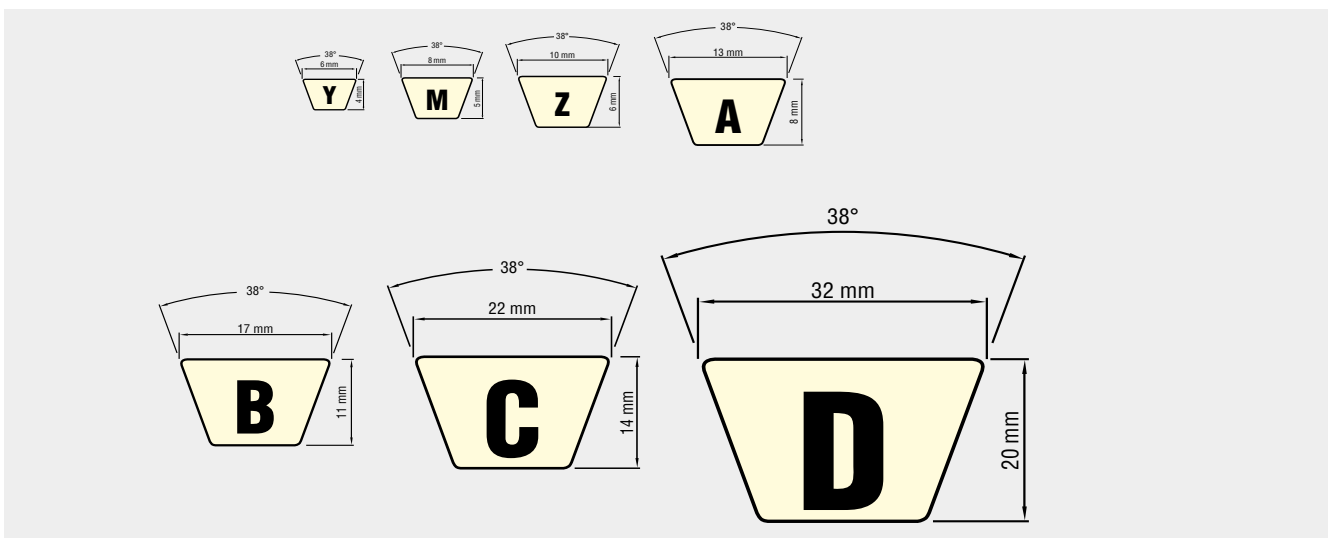

Calculation of round belt and V-belt cross section

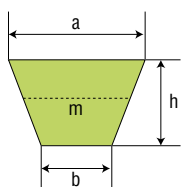

$$A_{cm^2} = \frac{a+b}{2} \times h = m \times h$$

$$m = \frac{a+b}{2}$$

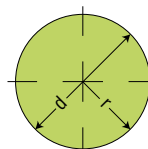

$$A_{cm^2} = \frac{\pi}{4} \times d^2 \approx 0,785 \times d^2$$

$$U = \pi \times d$$



Quick guide for belt calculation

The following three formulas provide information on the most important parameters for the design of a conveyor belt. With the help of these formulas, you can quickly and easily determine the pretension force, axle load and theoretical max. transport weight.

Of course, our experienced technical team will be happy to assist you. We look forward to your enquiry.

Phone: +49 7684 907 170

Support (influencing variables)

Which variables influence the values to be calculated?

Preload/axle load:

▲ Increase pretension

- + More power transmission
- + Less slip
- Increased axle and bearing load
- Increased Amp draw (motor)

▼ Reduce pretension

- + Less axle and bearing load
- + Less power consumption (motor)
- Increased slip/abrasion
- Belt tracking and alignment not guaranteed

k1% (Belt thickness and/or hardness)

▲ Increase k1%

- + Higher transport weight
- + Mechanically more robust
- Greater redirection
- Increased axle and bearing load
- Increased pretensioning force; Belt tensioner may be necessary

▼ Reduce k1%

- + Smaller redirection
- + Lower axle and bearing load
- Reduced transport weight
- Mechanically more susceptible

Reduce coefficient of friction (μ)

- ▶ Compared to steel, HDPE or PE substrates offer significantly lower friction resistance.
- ▶ Friction - optimized belt surfaces (e.g. rough, diamond, etc.) also reduce the coefficient of friction due to their smaller contact area.

PRETENSION FORCE (N)

$$k1\%_{stat.} \text{ (N/mm)} \times \text{belt width (mm)} \times \text{pretension (\%)} \times 2$$

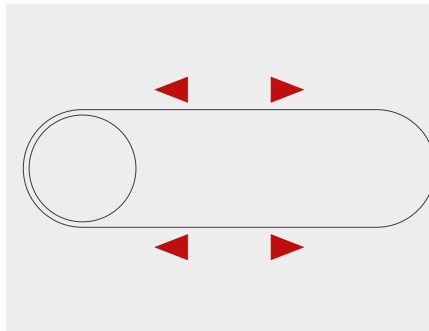

How much force (F) must be applied to pre-tension the belt?
What values are needed for this?

AXLE LOAD (N)

$$k1\%_{stat.} \text{ (N/mm)} \times \text{belt width (mm)} \times \text{pretension (\%)} \times 2$$

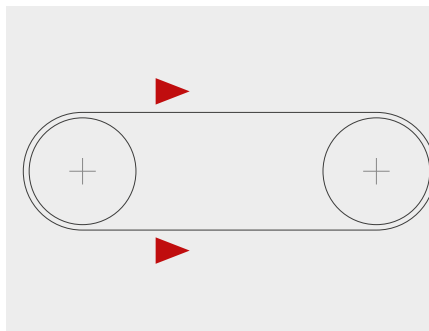

How much force (F) is applied to the axles due to the belt dimension?
How can the axle load be influenced (pretension, strength of the belt, hardness)?

MAX. TRANSPORT WEIGHT (KG)

$$k1\%_{relax.} \text{ (N/mm)} \times \text{belt width (mm)} \times \text{pretension (\%)} \times 0,1 / \text{coefficient of friction (\mu)}$$

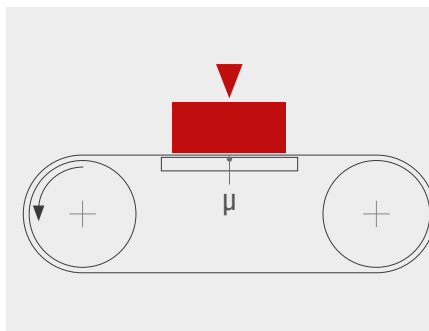

How much weight (kg) can be transported?
What is needed to calculate this?

K1% (N/mm): Modulus of elasticity of the respective conveyor belt (elasticity constant). This value indicates how much force (N) per unit of belt width (mm) is required to stretch a belt by 1%.

Belt width (mm): Functional width of the conveyor belt

Coefficient of friction (μ): Sliding coefficient of friction (in motion) between belt surface and contact surface of the belt support.

Pretension (%): Selected belt pretension of the elastic monolithic belts to create a frictional connection (force transmission without slip) between belt and drive element.

Manufacturing tolerances BEHAbelt round- and V-belts/conveyor belts

Description	Dimension mm		Tolerance ≈ mm
Round belts			
Type PU75A / 80A	∅ 2 - ∅ 8		± 0,2
Type PU75A / 80A	∅ 9 - ∅ 15		± 0,3
Type PU85A / 90A / 95A	∅ 2 - ∅ 8		± 0,2
Type PU85A / 90A / 95A	∅ 9 - ∅ 15		± 0,3
Type PU85A / 90A / 95A	∅ 18 - ∅ 20		± 0,5
Type TPE40D / 55D	∅ 3 - ∅ 8		± 0,2
Type TPE40D / 55D	∅ 9 - ∅ 15		± 0,3
Type TPE63D	∅ 6,3, ∅ 9,5, ∅ 12,5		± 0,3

Round belts can be produced on request in “-” or “+”-tolerance.

Description	Dimension mm	(ISO)		Tolerance ≈ mm	
V-belts DIN 2215				0-Width	Height
Type PU65A	6 - 8 - 10 - 13 - 17 - 22	(Y - M - Z - A - B - C)		- 0,5	+ 0,5
Type PU75A	6 - 8 - 10 - 13 - 17 - 22 - 32	(Y - M - Z - A - B - C - D)		- 0,5	+ 0,5
Type PU80A	6 - 8 - 10 - 13 - 17 - 22 - 32	(Y - M - Z - A - B - C - D)		- 0,5	+ 0,5
Type PU85A	6 - 8 - 10 - 13 - 17 - 22 - 32	(Y - M - Z - A - B - C - D)		- 0,5	+ 0,5
Type PU90A	8 - 10 - 13 - 17 - 22 - 32	(M - Z - A - B - C - D)		- 0,5	+ 0,5
Type TPE40D	8 - 10 - 13 - 17 - 22	(M - Z - A - B - C)		- 0,5	+ 0,5
Type TPE55D	8 - 10 - 13 - 17 - 22	(M - Z - A - B - C)		- 0,5	+ 0,5

Description	Dimension mm		Tolerance ≈ mm
Flat belt			
Belt thickness	0,9 / 1,0 / 1,2 / 1,6 / 2,0 / 3,0 / 4,0		+ / - 0,1

Manufacturing tolerances for tailoring

Production length (lf)	Production tolerance
150 - 1000 mm	± 2 mm
1001 - 4000 mm	± 3 mm
4001 - 10000 mm	± 5 mm
over 10000	± 10 mm

Production width	Production tolerance
< 100 mm	± 1,0 mm
> 100 mm	± 2,0 mm

Thickness	Production tolerance
0,9 / 1,0 / 1,2 / 1,6 / 2,0 / 3,0 / 4,0 mm	± 10% of the belt thickness

Manufacturing tolerances according to DIN EN ISO 15147 / DIN ISO 2768-m or DIN 16742-TG7. If you require tighter manufacturing tolerances for your application, we will be happy to check the possibility for you.





Technical request

Project		Phone		Name	
E-Mail		Address			

<input type="checkbox"/>	A	I'm looking for a replacement of an existing product. What performance would you like to improve:
<input type="checkbox"/>	B	I'm looking for a technical design support.

Please send to:
 Fax: +49 7684 907 101
 E-Mail: tech@behabelt.com

A

Basic information
for your inquiry

Product description (belt)		
Belt type, shape, size	Your sketch	
Hardness (Shore A or D)		
Type of surface		<input type="checkbox"/> smooth <input type="checkbox"/> matt <input type="checkbox"/> rough <input type="checkbox"/> textured <input type="checkbox"/> other:
Color		
Special product properties (FDA/EC, antistatic, UV, etc.)		
Supply of sample		<input type="checkbox"/> yes <input type="checkbox"/> no
Others		

Process description (conveyor)	
What is being done in the process?	
What products are being transported?	
What are the handled product properties?	
What happens before this process?	
What happens after this process?	

B

Basic information
for your inquiry

Conveyor layout			
Pulley diameters		Center distance	
Wrap angle		Belt speed	
Support or guide of belt		tensioning device/ take up amount	<input type="checkbox"/> yes, mm, <input type="checkbox"/> no
Max. belt load		numbers of belts that convey the load	

Environmental conditions			
What chemical requirements must the belt withstand?			
What is your cleaning procedure?			
Humidity / water	<input type="checkbox"/> normal <input type="checkbox"/> high <input type="checkbox"/> belt in water	UV-radiation	<input type="checkbox"/> yes <input type="checkbox"/> no
Is your belt subject to high abrasion?	<input type="checkbox"/> yes, due to:		<input type="checkbox"/> no
Environmental temperature (°C/°F)		Andere	

Needs assessment			
Order quantity (m/pc.)		Annual requirement (ft/pc.)	
Target Price		Standard coil length (ft)	
Packaging / coil form	<input type="checkbox"/> Wooden reel <input type="checkbox"/> Coil <input type="checkbox"/> Box <input type="checkbox"/> Cut to length <input type="checkbox"/> Special winding		



BEHA Innovation GmbH (Headquarters)

In den Engematten 16 · 79286 Glottertal/Germany
Phone: +49 7684 9070 · Fax: +49 7684 907101
E-Mail: info@behabelt.com · Internet: www.behabelt.com

BEHAbelt USA

835 Bonnie Lane · Elk Grove Village · IL 60007 · USA
Phone: +1 630 521 9835 · Fax: +1 630 521 9836
E-Mail: usa@behabelt.com · Internet: www.behabelt.com

You can find us here

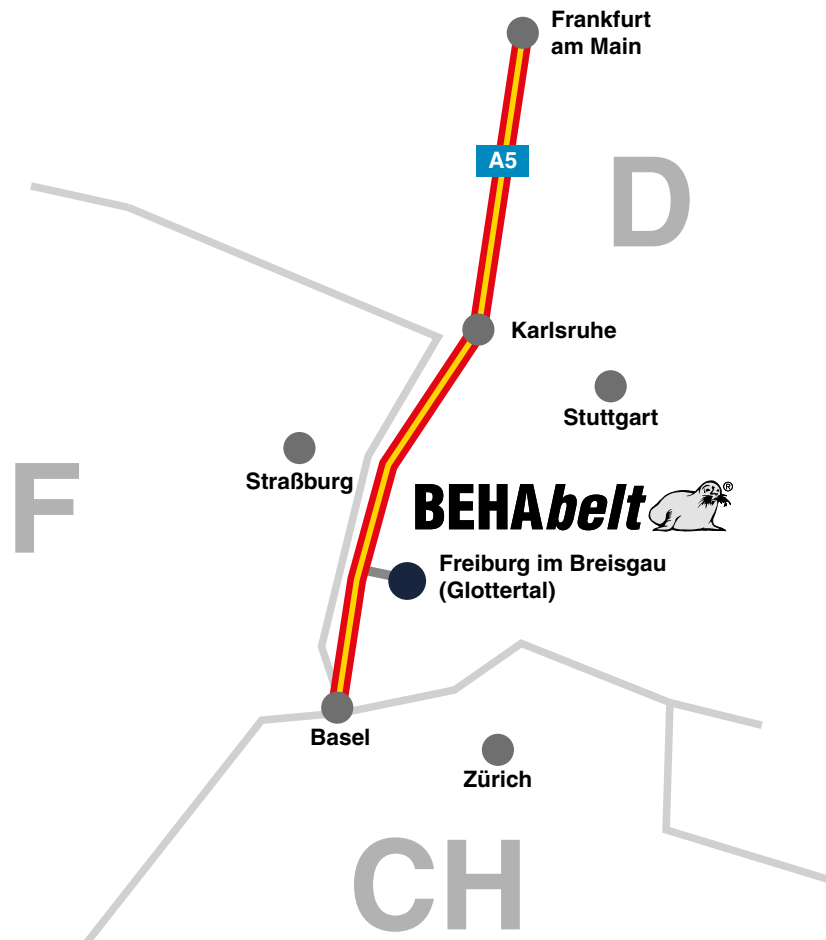

BEHAbelt products are available at your specialist dealer or our area representatives.

Your specialist dealer / system supplier - Autorizovaný distributor



TYMA CZ, s.r.o.

Na Pískách 731/12

CZ - 400 04 Trmice

Phone: +420 475 655 010

Email: info@tyma.cz www.tyma.cz

PBEPM0000116 · 04/23

BEHAbelt 

BEHA Innovation GmbH